

NM18  
STONE COURSE BASE  
PLAN 1 :100

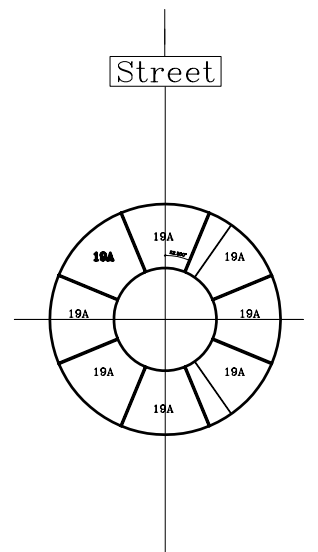

NM19  
STONE COURSE BASE  
PLAN 1 :100

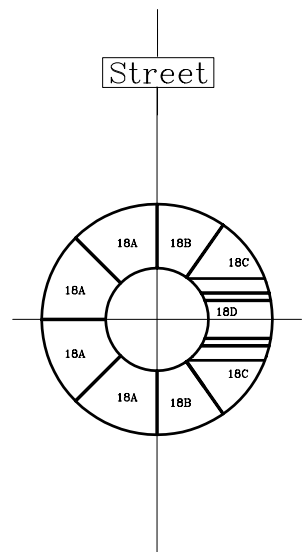

NM18  
STONE COURSE TOP  
PLAN 1 :100

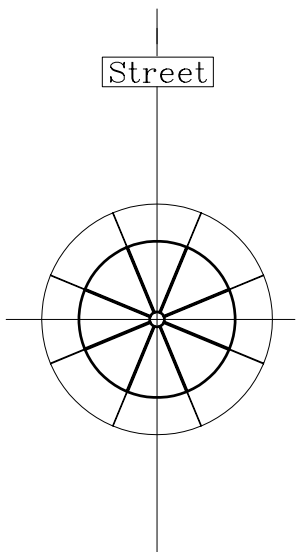

NM19  
STONE COURSE TOP  
PLAN 1 :100

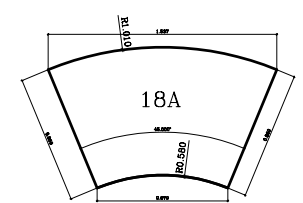

Bottom Plan  
Final Carved Stone  
NM18A plans 1:50

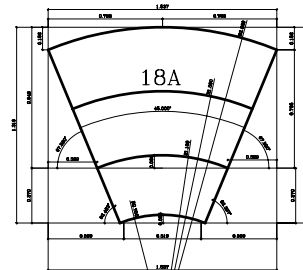

Ashler  
NM18A plan 1:50

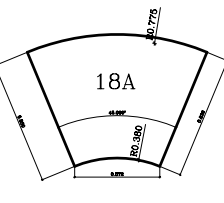
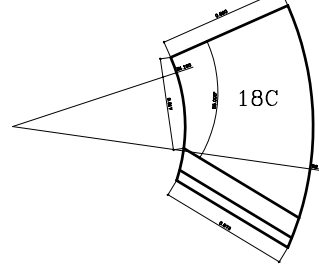

Top Plan  
NM18A plans 1:50

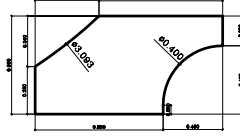

NM18A  
Section 1:50

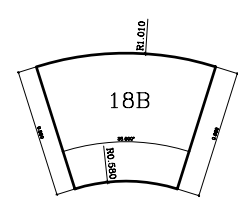

Bottom Plan  
Final Carved Stone  
NM18B plans 1:50

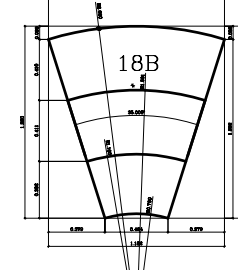

Ashler  
NM18B plan 1:50

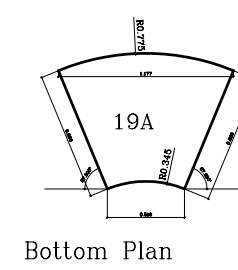

NM18B  
Section 1:50

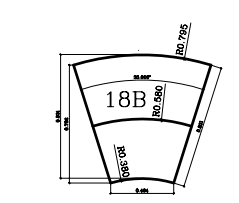

Top Plan  
NM18B plans 1:50

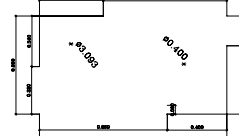

NM18B  
Section 1:50

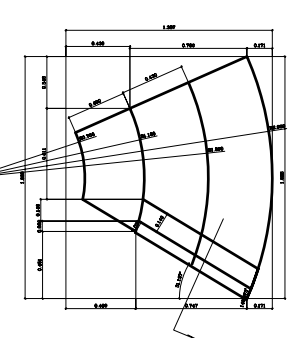

Ashler  
NM18C plan 1:50

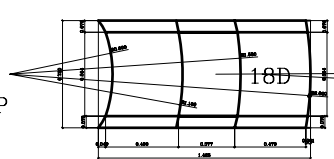

Ashler

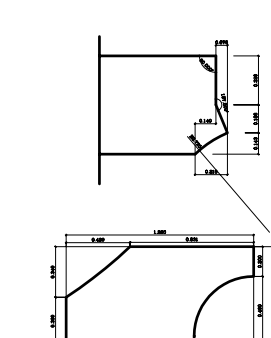

NM18C  
Section 1:50

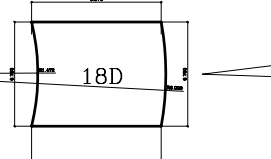

Bottom Plan  
NM18D plans 1:50

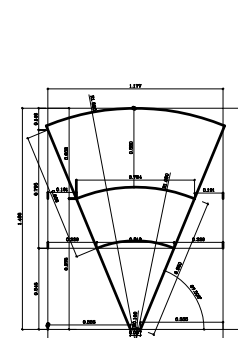

Ashler  
NM19A plan 1:50

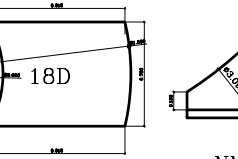

Top Plan

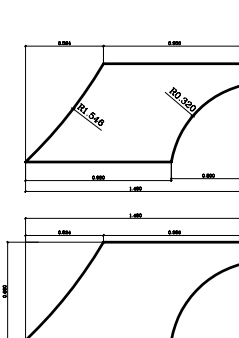

NM19A  
Section 1:50

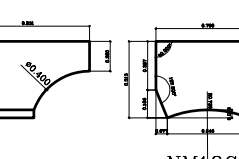

NM18C  
Section 1:50

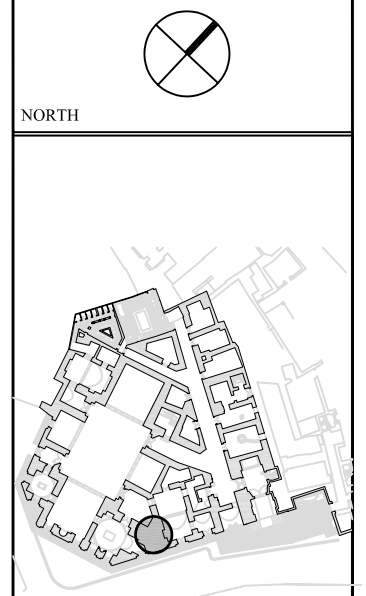

KEY PLAN

LEGEND

AGA KHAN TRUST FOR CULTURE  
Aga Khan Cultural Services-Egypt

UMM AS-SULTAN SHA'BAN MOSQUE & MADRASA  
CONSERVATION PROJECT  
CAIRO - EGYPT

DRAWING TITLE  
MINARET RECONSTRUCTION DETAILS

INTERVENTION DRAWINGS

SITE SURVEY: MLASHIEN  
DRAWING: MLASHIEN

SCALE: 1 : 50

PROJECT DATE: March 2003 - December 2006

DRAWING NO.: D - 07