

GV-TVD4811 AI 4MP H.265 5x Zoom Super Low Lux WDR Pro IR Vandal Proof IP

Dome



- AI deep learning: AI Perimeter Protection & Classification (Human, Vehicle)
- 1/2.7" progressive scan CMOS
- Min. illumination at 0.002 lux
- Triple streams from H.265, H.264 and MJPEG
- Up to 30 fps at 2688 x 1520
- Motorized lens for remote focus / zoom adjustment
- Intelligent IR
- IR distance up to 30 m (100 ft)
- Day and Night function (with removable IR-cut filter)
- Vandal resistance (IK10 for metal casing)
- Ingress protection (IP66)
- 3-axis mechanism (pan / tilt / rotate)
- DC 12V / PoE (IEEE 802.3af)
- Built-in micro SD card slot (SD / SDHC / SDXC / UHS-I, Class 10) for local storage
- Two-way audio capable
- Built-in microphone
- Pigtail-free
- Wide Dynamic Range Pro (WDR Pro)
- Defog
- 3D noise reduction
- Motion detection
- Text overlay
- Privacy mask
- Tampering Alarm
- 12 languages supported
- ONVIF (Profile G, S, T, M) conformant

Introduction

GV-TVD4811 is an outdoor camera designed with IK10 vandal resistance and IP66 ingress protection. GV-TVD4811 supports H.265 video codec to achieve better compression ratio while maintaining high quality pictures at reduced network bandwidths. The camera is equipped with an automatic IR-cut filter and IR LEDs for day and night surveillance. Adjustable in 3 axis (pan, tilt and rotate), it offers an entry-level surveillance solution with all the essential features and excellent image quality.

Empowered by deep learning algorithms, AI technology distinguishes human and vehicles from other moving objects. Integrated with GeoVision Video Management Software (VMS), it supports AI perimeter protection, real time alert, events playback and more.

Deep Learning Function

Face Detection



AI Perimeter Protection

(Intrusion, Crossing Line
Entering Area, Leaving Area)

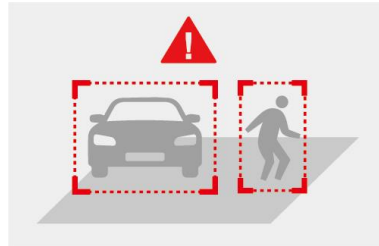

People Counting



Dimensions

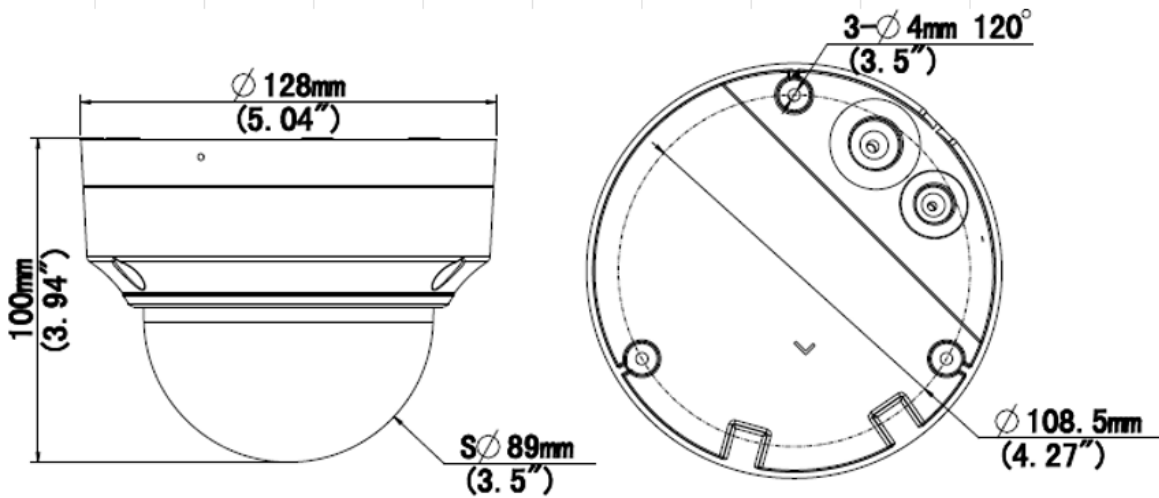

Specifications

Camera

Image Sensor	1/2.7" progressive scan CMOS	
Picture Elements	2688 (H) x 1520 (V)	
Minimum Illumination	Color	0.00 2Lux (F1.2, AGC ON)
	IR On	0 Lux
Shutter Speed	Automatic, Manual (1 ~ 1/100000 sec)	
White Balance	Automatic, Manual	
Gain Control	Automatic, Manual	
S/N Ratio	56 dB	
WDR Pro	Yes	
Dynamic Range	120 dB	

Lens

Megapixel	4 MP	
Day/Night	Yes (with removable IR-cut filter)	
Focal Length	2.7 ~ 13.5 mm	
Lens Type	Motorized varifocal lens	
Maximum Aperture	F/1.2	
Mount	Ø14 mm	
Horizontal FOV	103.58° ~ 31.05°	
Operation	Focus	Automatic / Manual
	Zoom	5x Optical Zoom
	Iris	Fixed
IR LED Quantity	2 IR LEDs	
Max. IR Distance	30 m (100 ft)	

DORI		Detect	Observe	Recognize	Identify
Lens	2.7 mm	60.8 m (199.5 ft)	24.3 m (79.7 ft)	12.2 m (40 ft)	6.1 m (20 ft)
	13.5 mm	303.8 m (996.7 ft)	121.5 m (398.6 ft)	60.8 m (199.5 ft)	30.4 m (99.7 ft)
Operation					
Video Compression		H.265, H.264, MJPEG			
Video Streaming		Triple streams			
Video Resolution	Main Stream	2688 x 1520 (Default), 2560 x 1440, 2304 x 1296, 1920 x 1080, 1280 x 720			
	Sub Stream	1280 x 720, 720 x 576, 640 x 480, 640 x 360 (Default)			
	Third Stream (Closed by Default)	720 x 576, 704 x 288, 640 x 360, 352 x 288			
Frame Rate		30 fps at 2688 x 1520, 30 fps at 2560 x 1440, 30 fps at 2304 x 1296, 30 fps at 1920 x 1080 (60 / 50 Hz) * The frame rate and performance may vary depending on the number of connections and data bitrates (different scenes).			
Maximum throughput		40 Mbps			
Maximum stream *When the total bitrate is within the maximum throughput		20			
Video Analytics		Motion Detection, Tampering Alarm, Audio Detection *Tampering alarm and audio detection are only accessible through the camera's Web interface, which can be used to trigger alerts such as e-mail and FTP			
Image Setting		Brightness, Contrast, Saturation, Sharpness, Flicker-less, 3D Noise Reduction, Image Orientation (Flip, Mirror, 0°, 90°, 180°, 270°-including Corridor format).			
Audio Compression		G.711			
Audio Support		Two-way Audio (external speaker required)			
Digital I/O	Input	1 Input, dry contact, NO / NC			
	Output	1 Relay Output (1A 30V DC / 0.3A 125V AC)			
Network					
Interface		10 /100 Ethernet			
Protocol		802.1x, ARP, DHCP, DDNS, DNS, FTP, HTTP, HTTPS, ICMP, IGMP, IPv4, IPv6, NTP, PPPoE, QoS, RTCP, RTP, RTSP, SMTP, SNMP, TCP, UDP, UPnP, ONVIF (Profile G, S, T, M)			
Deep Learning Function					
AI Analytics		<ul style="list-style-type: none"> - Intrusion, Cross Line, Enter Area, Leave Area: Human & Vehicle classification - People Flow Counting, Crowd Density Monitoring, Face Detection 			
Mechanical					
Camera Angle Adjustment	Pan	0° ~ 356°			
	Tilt	0° ~ 70°			
	Rotate	0° ~ 356°			
Connectors	Power	2-pin terminal block (DC 12 V, 1.25 A), PoE			
	Ethernet	RJ-45			
	Audio	1 built-in microphone 1 In and 1 Out (4-pin terminal block pitch 2.5 mm (0.1"))			
	Digital I/O	4-pin terminal block pitch 2.5 mm (0.1")			
	Local Storage	Micro SD card slot (SD / SDHC / SDXC / UHS-I, Class 10) * UHS-II card type is not supported.			
Face Detection					
Environment		100 lux			
Detectable face angle	≤ 10°	≤ 10°			
	≤ 30°	≤ 30°			
Max. number of faces		Up to 40			
Min. face image pixel requirement		80 pixels			
General					
Operating Temperature		-30°~ 60°C (-22° ~ 140°F)			
Humidity		0 ~ 95% (no condensation)			
Power Source		12 V DC / PoE (IEEE802.3af)			
Max. Power Consumption		6.5 W			
Dimensions		Ø 128 x 100 mm (Ø 5.04" x 3.94")			
Weight		0.59 kg (1.31 lb)			

Ingress Protection	IP66
Vandal Resistance	IK10 for metal casing
Certification	CE, FCC, LVD, RoHS, UL compliant
Web Interface	
Installation Management	Web-based configuration
Maintenance	Firmware upgrade through Web Browser or Utility
Access from Web Browser	Live View, Video Recording, Change Video Quality, Bandwidth Control, Image Snapshot, Text Overlay, Image Masking
Language	Czech, English, French, German, Hungarian, Italian, Japanese, Polish, Portuguese, Russian, Spanish, Traditional Chinese
Software Applications	
Software Supported	GV-VMS (V17.4.6 / V18.3.2 or later), GV-Control Center (V4.1.1 or later), GV-Edge Recording Manager Windows Version (V2.2.7 or later), GV-Recording Server / Video Gateway (V2.1.0 or later),
Smart Device Access	GV-Eye for iOS and Android (V3.1.0 or later)
Live Viewing	Bowser (IE, Edge, Chrome, Firefox), Mobile App







Note:



1. Do not use clothes or any ordinary material to clean the camera cover since they may result in scratches.
2. Specifications are subject to change without notice.

Packing List

- | | |
|-------------------------------|--------------------------------|
| 1. GV-TVD4811 Dome | 5. Torx Wrench |
| 2. 2-Pin Power Terminal Block | 6. Download Guide |
| 3. Screw Kit | 7. Cable Protection Connector |
| 4. Drill Template Paster | 8. Spare Waterproof Rubber Set |

Accessories

Model No.	Name		Details
GV-Mount107 (must be used with GV-Mount 212-P)	Pendant Bracket		Dimensions: Ø 120 x 334 mm (Ø 4.72" x 13.15") Weight: 0.74 kg (1.63 lb)
GV-Mount211P	Wall Mount and Junction Box		Dimensions: Ø 233 x 126 x 126 mm (Ø 9.2 x 5 x 5") Weight: 1 kg (2.2 lb)
GV-Mount212P	Wall Box Mount		Dimensions: Ø 126 x 36 mm (Ø 5.0 x 1.4") Weight: 0.22 kg (0.48 lb)
GV-Mount300-2	Convex Corner Mount		Dimensions: 137 x 233 x 160 mm (5.4" x 9.17" x 6.3") Weight: 1.65 kg (3.64 lb)
GV-Mount310-2	Concave Corner Mount		Dimensions: 111.2 x 369.9 x 210 mm (2.6" x 11.4" x 6.6") Weight: 1.65 kg (3.64 lb)
GV-Mount420 (must be used with GV-Mount211P)	Pole Mount Bracket		Dimensions: Ø 120 x 120 x 53.4 mm (Ø 4.7 x 4.7 x 2.1") Steel Strap Diameter: Ø 67 ~ 127 mm (Ø 2.6" ~ 5") Weight: 0.45 kg (0.99 lb)

GV-Mount704 (must be used with GV-Mount107)	Extension Tube		Dimensions: Ø 3.5 x 10 or 20 or 30 or 50 cm (Ø 1.38 x 3.9 or 7.9 or 11.8 or 19.7") Weight: 225g or 360g or 500g or 780g (0.5 lb or 0.79 lb or 1.1 lb or 1.72 lb)
GV-PA191	PoE Adapter		GV-PA191 is a Power over Ethernet (PoE) adapter designed to provide power to the IP device through a single Ethernet cable.
GV-PA301	Gigabit PoE Adapter		GV-PA301 is a Gigabit Power over Ethernet (PoE) adapter.
GV-POE Switch	GV-POE Switch is designed to provide power along with network connection for IP devices. The GV-POE Switch is available in various models with different numbers and types of ports.		
Power Adapter	Contact our sales representatives for the countries and areas supported.		