

GV-GEBF4911 Cloud AI 4MP H.265 4.3x Zoom Super Low Lux WDR Pro Full Color Warm LED IR Eyeball Dome IP Camera



- Direct-to-Cloud
- AI deep learning: AI Perimeter Protection & Classification (Human, Vehicle)
- 1/3" progressive scan CMOS sensor
- Triple streams from H.265, H.264 or MJPEG
- Min. illumination at 0.02 lux
- Up to 30 fps at 2592 x 1520
- Smart Warm LED distance up to 40 m (130 ft)
- Intelligent IR
- IR distance up to 40 m (130 ft)
- Wide Dynamic Range Pro (WDR Pro)
- Built-in microphone and speaker
- Built-in microSD card slot (SD / SDHC / SDXC) for local storage
- 3-axis mechanism (pan / tilt / rotate)
- Ingress protection (IP66)
- Vandal resistance (IK10 for metal casing)
- DC 12V / PoE (IEEE 802.3af)
- Defog
- 3D noise reduction
- GV-Center V2 connection
- AI analytics (Line Crossing, Region Entrance, Region Exiting, Target Counting, Region Intrusion, Face Detection, Video Metadata, Heat Map)
- Active Deterrence: Alarm sound and LED lights triggered upon AI events
- Smart lighting switch between IR LED (for motion detection) and Warm LED (for people detection)
- Motion detection
- Text overlay
- Privacy mask
- 12 languages supported
- ONVIF (Profile G, S, T, M) conformant

Introduction

GV-GEBF4911 is an outdoor eyeball dome IP camera equipped with smart warm LEDs for full color surveillance during nighttime. The camera supports H.265 video codec to achieve a better compression ratio while maintaining high-quality pictures at reduced network bandwidths. GV-GEBF4911 adheres to IK10 and IP66 standards, and can be powered through PoE.

Empowered by deep learning algorithms, its AI technology distinguishes humans and vehicles from other moving objects. When integrated with GeoVision Video Management Software (VMS), it supports AI perimeter protection, real-time alert, events playback, and more. By connecting the camera to the cloud-based data center and video surveillance solution, GV-Cloud VMS, thousands of on-site videos, alarm devices, and AI events can be monitored and managed from a single platform.

Deep Learning Function

Face Detection



AI Perimeter Protection

(Region Intrusion, Line Crossing, Region Entrance, Region Exiting)

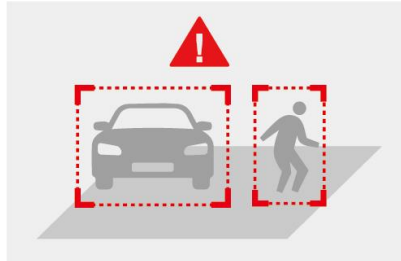

People Counting

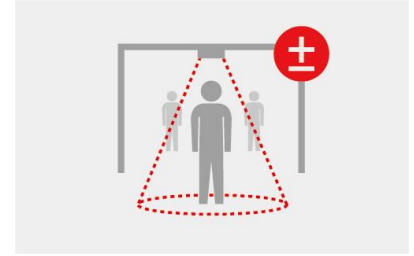

Dimensions

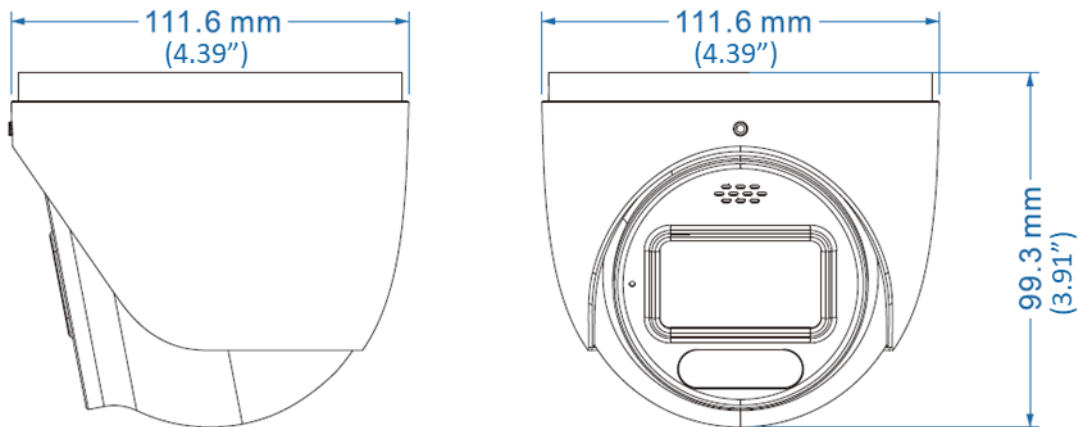

Specifications

Camera		
Image Sensor		1/3" progressive scan CMOS
Picture Elements		2592 (H) x 1520 (V)
Minimum Illumination	Color	0.02 Lux (F1.4, AGC ON)
Shutter Speed		Automatic / Manual (1/3 ~ 1/100000 sec)
White Balance		Automatic, Manual
Gain Control		Automatic, Manual
S/N Ratio		50 dB
WDR		WDR Pro
Dynamic Range		120 dB
Lens		
Megapixel		4MP
Day / Night		Yes (with removable IR-cut filter)
Lens Type		Motorized
Focal Length		2.8 -12 mm
Maximum Aperture		F/1.4
Mount		Ø 14
FOV	Horizontal	96°~32.33°
	Vertical	53.67°~19.63°
	Diagonal	114.17°~36.33°
Operation	Focus	Auto / Manual
	Zoom	4.3x
	Iris	DC

Active Deterrence LED		1 red and blue LED			
IR LED	Quantity	1 IR LED			
	Max. IR Distance	40 m (130 ft)			
Warm LED	Quantity	1 Warm LED			
	Max. Warm LED Light Distance	40 m (130 ft)			
DORI		Detect	Observe	Recognize	Identify
Lens	(W) 2.8 – 12 mm	60.0 m (196.8 ft)	24.0 m (78.7 ft)	12.0 m (39.3 ft)	6.0 m (19.6 ft)
	(T) 2.8 – 12 mm	175.7 m (576.4 ft)	70.2 m (230.3 ft)	35.1 m (115.1 ft)	17.5 m (57.4 ft)
Operation					
Video Compression		H.265, H.265+, H.264, H.264+, MJPEG			
Video Streaming		Triple streams from H.265, H.264 or MJPEG			
Frame Rate		30 fps at 2592 x 1520, 2560 x 1440, 2304 x 1296, 1920 x 1080, 1280 x 720, 704 x 480, 640 x 480, 352 x 240, 480 x 240 (60 Hz)			
		25 fps at 2592 x 1520, 2560 x 1440, 2304 x 1296, 1920 x 1080, 1280 x 720, 704 x 567, 640 x 480, 352 x 288, 480 x 240 (50 Hz)			
		*The frame rate and performance may vary depending on the number of connections and data bitrates (different scenes).			
Maximum Throughput		80 Mbps			
Maximum Streams		10			
*When the total bitrate is within the maximum throughput		*By default, 2 connections are occupied whether connected to GV-Cloud VMS or not.			
Video Analytics		Motion Detection, Video Exception Detection (Abnormal Color Detection, Scene Change, Video Blur), Object Abandoned/Missing Detection			
Smart Alarm		Audio Exception, Cable Disconnection, IP Address Conflict, SD Card Error, SD Card Full			
Image Setting		Brightness, Contrast, Saturation, Sharpness, Antiflicker, 3D Noise Reduction, Image Orientation (Flip, Mirror, 0°, 90°, 180°, 270°-including Corridor format)			
Audio Compression		G.711			
Audio Support		Two-way Audio			
Digital I/O	Input	1 input, dry contact, NO/NC			
	Output	1 relay output (1A 30V DC / 0.3A 125V AC)			
Video Resolution					
Main Stream		2592 x 1520 (Default), 2560 x 1440, 2304 x 1296, 1920 x 1080, 1280 x 720			
Sub Stream		1280 x 720 (Default), 704 x 480, 640 x 480, 352 x 240			
Third Stream (Closed by Default)		704 x 480, 640 x 480, 352 x 240, 480 x 240			
Network					
Interface		10/100 Ethernet			
Protocol		UDP, IPv4, IPv6, DHCP, NTP, RTSP, RTP, RTCP, PPPoE, DDNS, SMTP, FTP, SNMP, RTMP, HTTP, 802.1x, UPnP, HTTPS, QoS, ONVIF (Profile G, S, T, M), API			
Deep Learning Function					
AI Analytics		<p>Face Event: Face Detection</p> <p>Smart Event:</p> <ul style="list-style-type: none"> - Line Crossing, Region Entrance, Region Exiting, Region Intrusion, Target Counting, Heat Map, Video Metadata: Human & Vehicle classification <p>*Face events and smart events cannot be enabled at the same time.</p> <p>*A maximum of 2 smart detection functions are suggested at a time to ensure comprehensive detection results and the optimized performance by the camera.</p> <p>*Once connected to GV-Cloud VMS / GV-Center V2, up to 2 smart detection functions are supported.</p>			
Video Metadata	People	Gender, Age, Top / Bottom (Type, Color), Accessories (Hat, Bag, Face Mask, Glasses)			
	Vehicle	Type, Color, Brand, Model			
	Non-Motor Vehicle	Type			
Mechanical					
Camera Angle Adjustment	Pan	0° ~ 360°			
	Tilt	0° ~ 75°			
	Rotate	0° ~ 360°			

Connectors	Power	DC 12V, PoE (IEEE 802.3af)	
	Ethernet	RJ-45	
	Audio	Built-in microphone	Yes
		External microphone required	Yes (audio jack, 3.5 mm or 0.14 in)
		Built-in speaker	Yes
		External speaker required	Yes (audio jack, 3.5 mm or 0.14 in)
		* Choose either the built-in or external option for devices with a microphone or speaker. * The Audio In port only supports microphones with a power supply.	
Digital I/O	4-pin terminal block pitch 3.5 mm (0.14")		
Local Storage	microSD card slot (SD / SDHC / SDXC), up to 256 GB		

General

Operation Temperature	-30 ~ 60°C (-22 ~ 140°F)
Humidity	0% ~ 95% (no condensation)
Power Source	DC 12V, PoE (IEEE 802.3af)
Max. Power Consumption	12W
Dimensions	∅ 111.6 x 99.3 mm (∅ 4.39 x 3.91 in)
Weight	0.64 kg (1.41 lb)
Ingress Protection	IP66
Vandal Resistance	IK10 for metal casing
Certification	CE, FCC, RoHS compliant

Web Interface

Installation Management	Web-based configuration
Maintenance	Firmware upgrade through Web Browser or Utility
Access from Web Browser	Live View, Playback, Video Recording, Image Quality, Bandwidth Control, Image Snapshot, Two-way Audio, Digital Zoom, Text Overlay, Image Masking, Intelligent Mark
Language	Chinese Traditional, Czech, English, French, German, Hungarian, Italian, Japanese, Polish, Portuguese, Russian, Spanish

Software Applications

Software Supported	GV-VMS (V17.4.7 / V18.3.2 / V20.0.0 or later), GV-Edge Recording Manager (V2.2.8 or later), GV-Control Center (V4.1.1 or later), GV-Recording Server (V2.1.1 or later), GV-Center V2 (V18.4.1 or later), GV-Cloud VMS (V1.0.0 or later), GV-IP Device Utility (V8.9.9 or later)
Smart Device Access	GV-Eye for iOS and Android (V3.2.0 or later)
Live Viewing	Web Browser (Edge, IE mode in Edge, Chrome, Firefox, Safari), Mobile App



Note:

- To use GV-Cloud VMS, avoid connecting to other GV-Software at the same time.
- To use GV-Cloud VMS, a microSD card must be installed. Industrial-grade microSD cards are recommended to avoid event recordings writing failure.
- Upon the initial connection of GV-Cloud Camera to GV-Cloud VMS, the Standard Plan will be provided for free for 180 days.
- GV-Center V2 Standard / Pro can only receive motion events from GV-Cloud IP Cameras. To receive AI and PVD events, GV-Center V2 AI is required.
- Specifications are subject to change without notice.



Packing List

- | | |
|-----------------------------|--------------------------|
| 1. GV-GEBF4911 Eyeball Dome | 4. Hex Key |
| 2. Waterproof Rubber Set | 5. Drill Template Paster |
| 3. Screw kit | 6. Download Guide |

Accessories

Model No.	Name		Details
GV-Mount211-4	Wall Mount Bracket		Dimensions: 129.5 x 155 x 74.5 mm (5.10 x 6.10 x 2.93 in) Weight: 0.53 kg (1.16 lb)
GV-Mount211-6 (must be used with Mount506)	Wall Mount Bracket		Dimensions: 199 x 139.3 x 140.6 mm (7.83 x 5.48 x 5.54 in) Weight: 0.56 kg (1.23 lb)
GV-Mount470 (must be used with Mount211-6 or 506)	Pole Mount Bracket		Dimensions: 163.3 x 54.5 x 215 mm (6.43 x 2.15 x 8.46 in) Weight: 1.10 kg (2.43 lb)
GV-Mount314 (must be used with Mount211-6 or 506)	Corner Mount Bracket		Dimensions: 215 x 121.4 x 215 mm (8.46 x 4.78 x 8.46 in) Weight: 2.05 kg (4.52 lb)
GV-Mount506	Junction Box		Dimensions: 139.3 x 171.6 x 50 mm (5.48 x 6.76 x 1.97 in) Weight: 0.51 kg (1.13 lb)
GV-PA191	PoE Adapter		GV-PA191 is a Power over Ethernet (PoE) adapter designed to provide power to the IP device through a single Ethernet cable.
GV-PA301	Gigabit PoE Adapter		GV-PA301 is a Gigabit Power over Ethernet (PoE) adapter.
GV-POE Switch			GV-POE Switch is designed to provide power along with network connection for IP devices. The GV-POE Switch is available in various models with different numbers and types of ports.
Power Adapter			Contact our sales representatives for the countries and areas supported.

Mounting Type

Wall Bracket Mount GV-Mount211-4	Junction Box Mount GV-Mount506	Junction Box Mount GV-Mount506	Wall Bracket Mount GV-Mount211-6
			

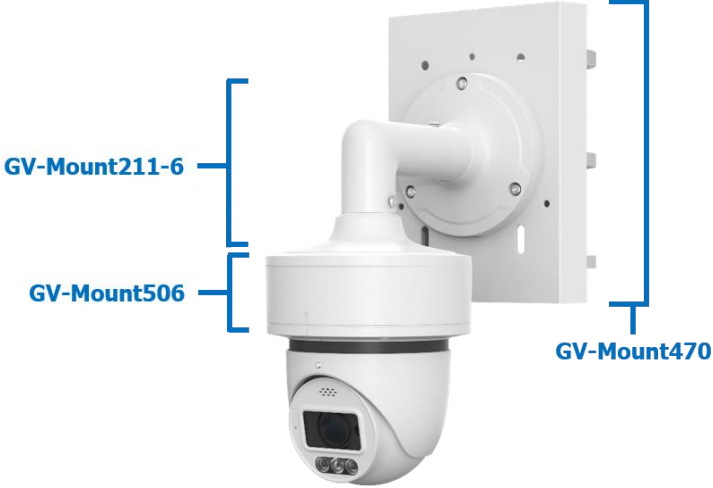
Junction Box Mount GV-Mount506	Wall Bracket Mount GV-Mount211-6	Pole Bracket Mount GV-Mount470
		

Junction Box Mount GV-Mount506	Pole Bracket Mount GV-Mount470
	

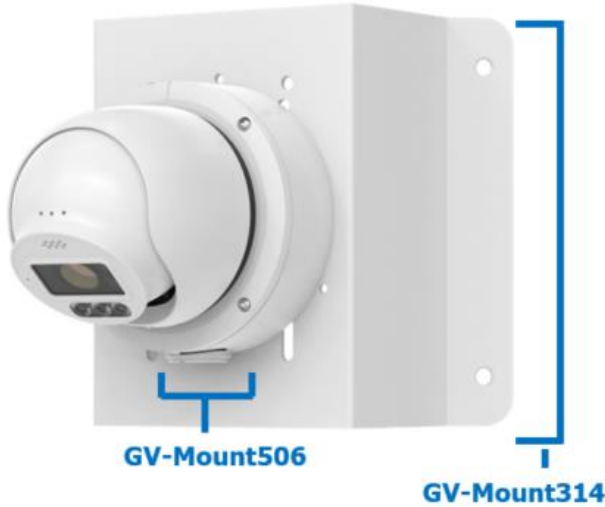
Junction Box Mount	Corner Mount Bracket
GV-Mount506	GV-Mount314
	

Junction Box Mount	Wall Bracket Mount	Corner Mount Bracket
GV-Mount506	GV-Mount211-6	GV-Mount314
