

FYPON

FULL-LINE CATALOG



MANIFEST YOUR OUTER HOME



Manifest your outer home.

Tailored architectural details for your unique style.

More than 50 years ago, we unlocked the science behind modern molding technology to create better-than-nature decorative trim.

Fypon makes homes better with durable, weather-resistant millwork solutions that are engineered for ease of installation, provide long-lasting low maintenance, deliver performance for long-term value and are backed by a lifetime limited warranty for peace of mind.

TABLE OF CONTENTS

4-5	Discover Fypon
6-7	Outdoor Trends
8-19	Featured Products
20-89	Window & Door Trim
90-127	Mouldings
128-209	Decorative Millwork
210-227	Louvers
228-247	Column Wraps
248-259	Rail Systems
260-277	Balustrades, Porch Post, Columns
278-315	Index



We are proud to be an official corporate partner of Yellowstone Forever's sustainability initiative to help ensure that Yellowstone National Park remains for generations. We're proud to provide fiberglass entryways for Yellowstone Park employee housing.

Discover the Fypon® Advantage

THE RESOURCES YOU NEED

Building professionals trust Fypon to deliver outstanding customer service and support. We provide:

- An industry-first quote package program with quantity pricing tool.
- Support from Fypon experts and answers to common installation questions.
- Takeoff services for historical restorations, replicas or any unique profile that fits your home or commercial application.

For more information, contact FPS@fypon.com

TAKEOFF SERVICES FOR ARCHITECTS AND BUILDERS

Fypon offers architects and builders a free takeoff service, allowing busy contractors more time to focus on their projects. Included in our quote package is a color-coded takeoff and an estimate sheet with pricing.

Fypon also offers customers custom products if their project is \$10,000 list price or higher. This can include a combination of custom and stock products.

For more information, contact FPS@fypon.com or call 1.855.397.6647.

CUTTING AND MILLING

Fypon polyurethane products can be cut and trimmed with standard woodworking tools, including table saws, circular saws, jig saws, band saws and miter saws. Trimming product will remove the smooth finish and create an exposed polyurethane edge. This edge must be primed to protect the exposed polyurethane. Fypon polyurethane products must be finished with paint or stain within 90 days of installation to protect the product from discoloration from the sun. For more information on the installation and care of Fypon products, visit fypon.com.

INSTALL

Installation instructions for all Fypon products can be found on our website at fypon.com/install.

REMEMBER TO ORDER ADHESIVE

A urethane-based adhesive must be used on all polyurethane joint surfaces.

Fypon recommends Loctite® PL Premium® Adhesive.

For PVC products, such as column wraps, Fypon recommends Duo-Sil® adhesive and caulk. See pages 230 and 278 for ordering information.





Where style meets serenity.

Today's design trends invite you to create a relaxing retreat that reflects your home's unique style. Whether you're drawn to nostalgic charm, timeless elegance or laid-back luxury, we offer the products that will help turn your home into a haven.

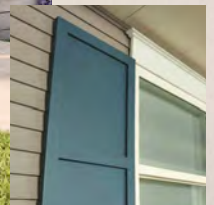

MODERN HARMONY

NOSTALGIC | INDUSTRIAL | ORGANIC

Retro styles meet nature-inspired influences as Modern homes lean into lighter hues, warm wood grains and mixed textures.

FEATURED PRODUCTS:

PremiumSelect Flat-Pack Square Column Wrap with Roman Square Cap | Shaker-Style Shutter 2-Flat Panel | Smooth Beams



BALANCED BLEND

CRAFTED | TEXTURAL | WELCOMING

The new Casual aesthetic features trend-forward colors and finishes in perfect harmony with elevated-but-comfortable details like vertical textures and eased edges.

FEATURED PRODUCTS:

PremiumSelect Tapered Column Wraps | Shaker-Style Shutters | Craftsman Step Crosshead and Smooth Flat Trim | Brackets and Dentil Blocks | Rough Sawn Beam Mantel

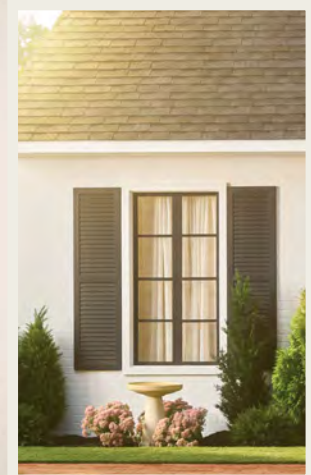

WELL TAILORED

DECORATIVE | TRANSITIONAL | REFINED

Traditional homes blend European-inspired elements with tailored details, including mixed wood grains and a moody color palette, for a fresh take on Old World style.

FEATURED PRODUCTS:

PremiumSelect Square Column Wrap | Louvered Shutters | ProSelect Square Column Wraps



CLASSIC MANTEL

Recreate the stately appeal of traditional ornamentation within your own home using our Classic mantel. See pages 136–137 for more details.

Featured Products



SMOOTH BEAM MANTEL

Offering a clean focal point for any space, our smooth beam mantel allows you to create a truly custom look for your home. See pages 132–133 for more details.



STEPPED MANTEL

With its tiered design, our Stepped mantel draws attention upward, putting greater emphasis on the verticality of a space. See pages 134–135 for more details.

Featured Products



LOUVERED SHUTTERS

Enhance your home's curb appeal with the classic appeal of Louvered Panel shutters to create a consistent style from your windows to your entryway. See pages 24–25 for more details.



RAISED PANEL SHUTTERS

Give your entry door additional charm with the flexible style of Raised Panel shutters. Available in a smooth finish. See pages 26–27 for more details.

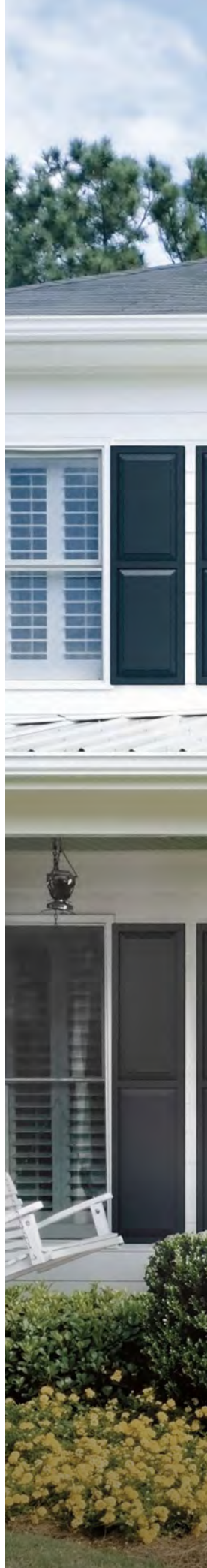





Featured Products



GABLE PEDIMENTS

Add a charming touch to any home's exterior with wood-grained Fypon® gable pediments. Choose from wood-grained Burnham, Meier, Sullivan and Asher, as well as our flat-style pediments available in smooth and wood-grained textures. Explore available sizes on pages 156–165.

Featured Products



WOOD-GRAINED FLAT GABLE PEDIMENTS

Fypon® wood-grained flat gable pediments are available in a variety of roof pitches, pairing perfectly with any Craftsman-style home. Learn more on page 162.



SMOOTH FLAT GABLE PEDIMENTS

Perfectly blending classic style with modern versatility, Fypon® smooth flat gable pediments draw lines of sight to the most important details of your home. Learn more on page 163.



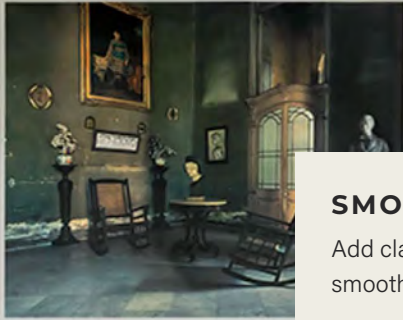

SMOOTH BEAMS

Add classic architectural charm to any home with Fypon® smooth beams. Learn more on page 142-145.



Featured Products



WOOD-GRAINED BEAMS

Fypon® wood-grained beams give any room a distinct rustic charm without the hassle of wood. Available in four distinct styles. Learn more on page 146–153.



BEAM STRAPS

Beam straps can be used to add an authentic, rustic look to wood-grained beams. See page 154 for details.

Featured Products



SMOOTH & WOOD-GRAINED BRACKETS

Fypon® offers brackets that can easily be added to a home's interior or exterior for a decorative touch. See more on pages 166–180 and 190–192.









An unforgettable first impression.

Transform the look of any home with Fypon® window and door trim. Designed to work together, these pieces are quick and easy to install.

WINDOW & DOOR TRIM

- 24 Smooth Shutters
- 32 Smooth Shutter Board Fabrication Panels
- 34 Wood-Grained Shutters
- 53 Wood-Grained Shutter Board Fabrication Panels
- 53 Shutter Accessories
- 54 Crossheads
- 68 Pediments
- 78 Pilasters
- 84 Window Trim
- 88 Window Panel
- 88 Dormer Trim System
- 89 Keystones

Window & Door Trim

HOW TO USE THIS SECTION

Where applicable, part numbers are shown for products with attached accessories, or other available unattached accessories are referenced or shown with the product.

HOW TO ORDER DOOR TRIM & ENTRANCE SYSTEMS

When ordering door trim, first measure the door unit to be trimmed. The unit can be measured with or without brickmould; however, the brickmould is essential when using a storm door. Next, choose the desired pilaster style and size. Finally, choose a pediment or crosshead that is wide enough to span the opening plus the brickmould and pilasters or flat trim. Add desired accessories to complete the look.

WINDOW & DOOR TRIM ACCESSORIES

Keystones, dentil trim, trim strip and bottom trim accessories are available attached to standard products as fabricated products. A keystone can also be ordered as an unattached accessory.

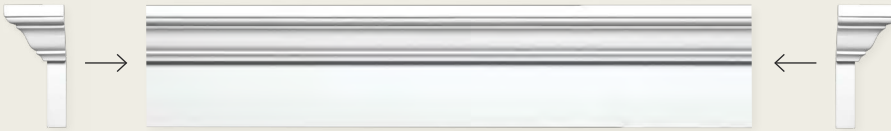

HOW TO ORDER TRIMMABLE CROSSHEAD

EXAMPLE

- | | | |
|---|---|--|
| 1 | Determine height. | 6" high |
| 2 | Determine breast board width of crosshead. | 36" width |
| 3 | Select end cap width. End cap widths should coordinate with pilaster or moulding on either side of door / window. If no moulding is used, then any end cap can be selected. | CHC4X6 (Coordinating over 3-1/2" flat trim.) |
| 4 | Calculate trimmable crosshead; account for end cap.
Crosshead breast board width - (end cap back surface x 2) = trimmable crosshead. | $36" - (2\text{-}1/2" \times 2) = 31"$ required ¹ |
| 5 | Select trimmable crosshead. | CHT36X6 |
| 6 | Optional: Select accessory moulding / keystone. | K6M and MLD716-12 |

¹End cap back surface.

Note: Always consult the local building code authority to determine suitability of products to meet specific project requirements.

Window & Door Trim Applications

DISTINCTION CROSSHEAD WITH END CAPS

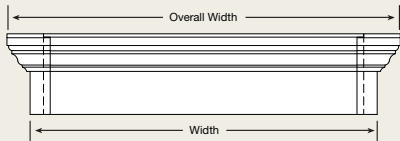

CRAFTSMAN COVE CROSSHEAD WITH END CAPS

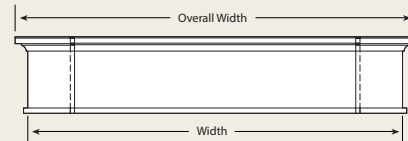

CLASSIC CROSSHEAD WITHOUT ACCESSORIES

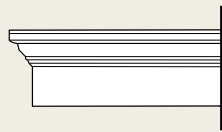

CLASSIC CROSSHEAD WITH ACCESSORIES

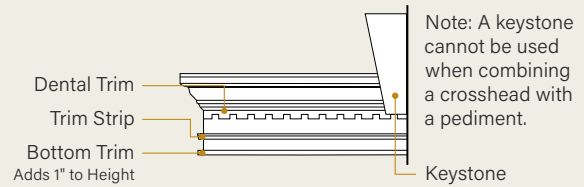

WINDOW TRIM TERMINOLOGY

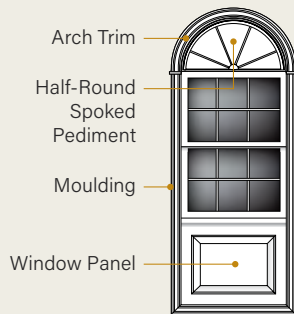

KEystone OPTIONS



Flat



Recessed

CROSSHEAD OPTIONS FOR ENTRYWAY

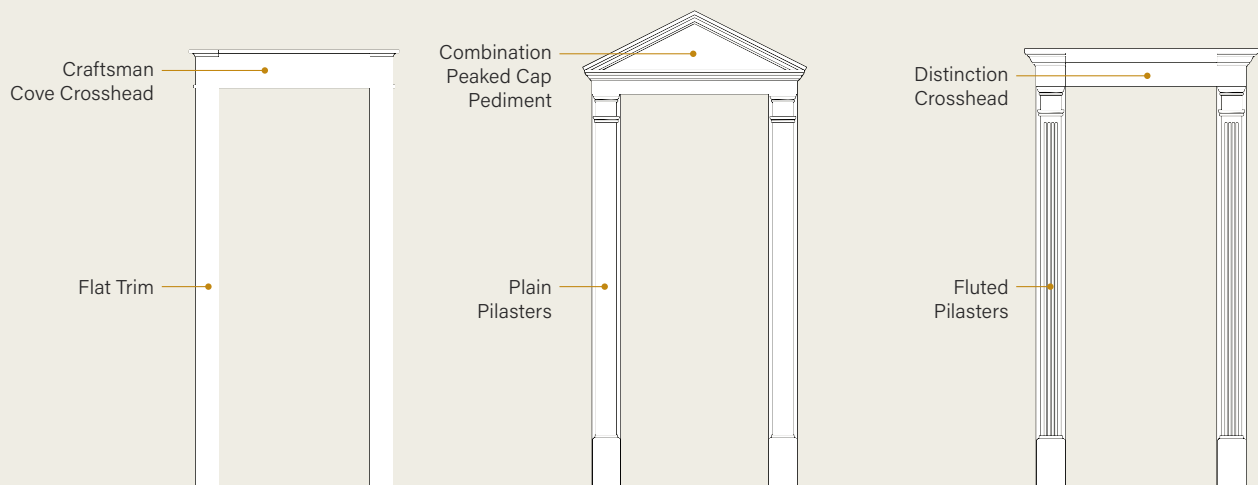

Louvered Shutter

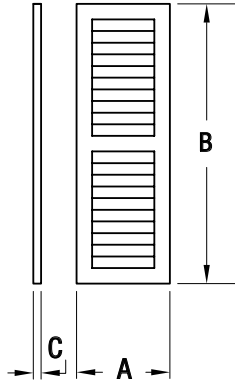

WITH CENTER RAIL

Part Number	Width (A)	Height (B)	Projection (C)
LVSH12X36FNCR	12"	36"	1"
LVSH12X48FNCR	12"	48"	1"
LVSH16X54FNCR	16"	54"	1"
LVSH16X60FNCR	16"	60"	1"
LVSH16X72FNCR	16"	72"	1"
LVSH16X80FNCR	16"	80"	1"
LVSH16X84FNCR	16"	84"	1"
LVSH18X60FNCR	18"	60"	1"
LVSH18X66FNCR	18"	66"	1"
LVSH18X72FNCR	18"	72"	1"
LVSH18X84FNCR	18"	84"	1"
LVSH18X96FNCR	18"	96"	1"
LVSH24X60FNCR	24"	60"	1"
LVSH24X72FNCR	24"	72"	1"

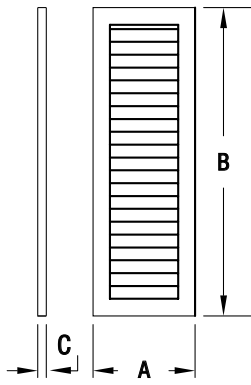

WITHOUT CENTER RAIL

Part Number	Width (A)	Height (B)	Projection (C)
LVSH16X54FNB	16"	54"	1"
LVSH16X72FNB	16"	72"	1"
LVSH18X54FNB	18"	54"	1"
LVSH18X60FNB	18"	60"	1"
LVSH18X72FNB	18"	72"	1"
LVSH24X60FNB	24"	60"	1"
LVSH24X72FNB	24"	72"	1"





Raised Panel Shutter

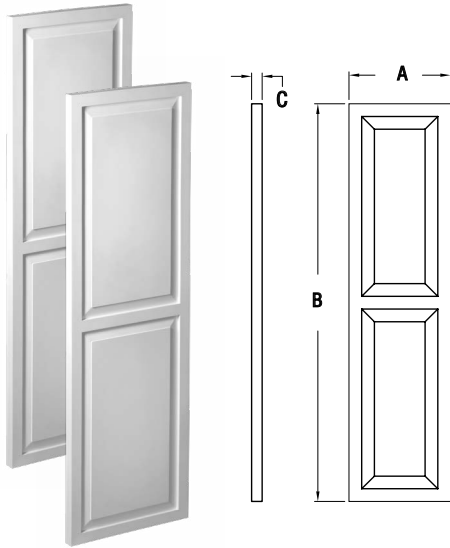

DOUBLE PANEL

Part Number	Width (A)	Height (B)	Projection (C)
SH16X48DP	16"	48"	1-1/4"
SH16X54DP	16"	54"	1-1/4"
SH16X60DP	16"	60"	1-1/4"
SH16X65DP	16"	65"	1-1/4"
SH16X72DP	16"	72"	1-1/4"
SH16X84DP	16"	84"	1-1/4"
SH16X96DP	16"	96"	1-1/4"
SH18X53DP	18"	53"	1-1/4"
SH18X59DP	18"	59"	1-1/4"
SH18X60DP	18"	60"	1-1/4"
SH18X66DP	18"	66"	1-1/4"
SH18X72DP	18"	72"	1-1/4"
SH18X80DP	18"	80"	1-1/4"
SH18X84DP	18"	84"	1-1/4"
SH18X96DP	18"	96"	1-1/4"
SH24X66DP	24"	66"	1-1/4"



Modern Farmhouse Shaker-Style Shutters



See the product through your mobile device at fypon.com/AR

- Available in widths measuring 12", 16", 18" and 24", and heights measuring 24"–120" in 1" increments.
- 2" wide stiles and 2-1/2" wide batten create the X-batten design.
- Stiles 1-3/8" deep with 5/8" recessed panel.
- Shaker-style shutter panels and flat trim are available to create your own farmhouse design, details on page 32.

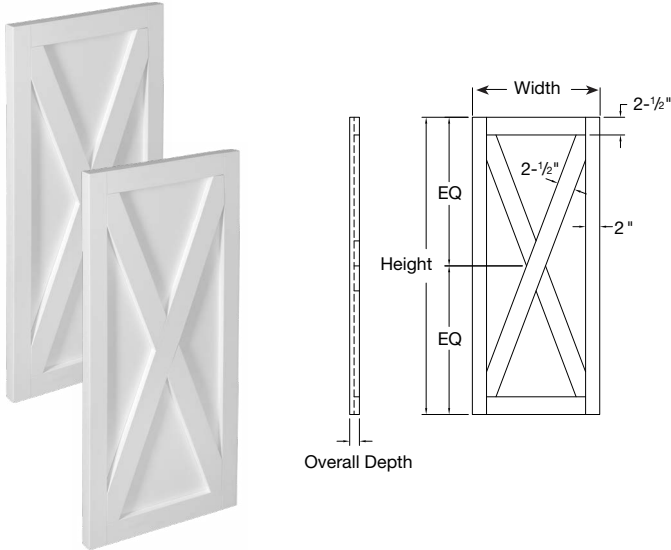

Part numbers shown reflect common sizes.
For additional options, follow the part number logic below
or contact your Fypon® representative.

SHMFH12X24

[Profile]
SH = Shutter

[Configuration]
MFH = Modern
Farmhouse style

[Width]
12 = 12"
16 = 16"
18 = 18"
24 = 24"

[Height]
(1" Increments)
24 = 24" [Minimum]
120 = 120" [Maximum]

12"	16"	18"	24"
SHMFH12X24	SHMFH16X24	SHMFH18X24	SHMFH24X24
SHMFH12X36	SHMFH16X36	SHMFH18X36	SHMFH24X36
SHMFH12X48	SHMFH16X48	SHMFH18X48	SHMFH24X48
SHMFH12X60	SHMFH16X60	SHMFH18X60	SHMFH24X60
SHMFH12X72	SHMFH16X72	SHMFH18X72	SHMFH24X72
SHMFH12X84	SHMFH16X84	SHMFH18X84	SHMFH24X84
SHMFH12X96	SHMFH16X96	SHMFH18X96	SHMFH24X96
SHMFH12X108	SHMFH16X108	SHMFH18X108	SHMFH24X108
SHMFH12X120	SHMFH16X120	SHMFH18X120	SHMFH24X120





Shaker-Style Shutters

- Features 2-flat panel recessed stile and rail design.
- Available in widths measuring 12", 16", 18" and 24", and heights measuring 24"-120" in 1" increments.
- 2" wide stiles with 2-1/2" wide rails. Center rail is positioned in the center of the shutter.
- Stiles 1-3/8" deep with 5/8" recessed panel.
- Shaker-style shutter panels and flat trim are available to create your own Craftsman design, details on page 32.

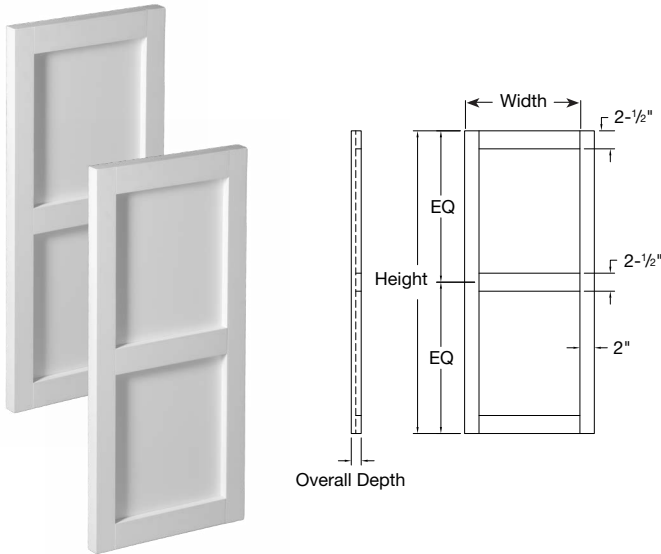

Part numbers shown reflect common sizes.
For additional options, follow the part number logic below
or contact your Fypon® representative.





SH2FP12X24

<p>[Profile] SH = Shutter</p>	<p>[Configuration] 2FP = 2-Flat Panel</p>	<p>[Height] (1" Increments) 24 = 24" [Minimum] 120 = 120" [Maximum]</p>
	<p>[Width] 12 = 12" 16 = 16" 18 = 18" 24 = 24"</p>	

12"	16"	18"	24"
SH2FP12X24	SH2FP16X24	SH2FP18X24	SH2FP24X24
SH2FP12X36	SH2FP16X36	SH2FP18X36	SH2FP24X36
SH2FP12X48	SH2FP16X48	SH2FP18X48	SH2FP24X48
SH2FP12X60	SH2FP16X60	SH2FP18X60	SH2FP24X60
SH2FP12X72	SH2FP16X72	SH2FP18X72	SH2FP24X72
SH2FP12X84	SH2FP16X84	SH2FP18X84	SH2FP24X84
SH2FP12X96	SH2FP16X96	SH2FP18X96	SH2FP24X96
SH2FP12X108	SH2FP16X108	SH2FP18X108	SH2FP24X108
SH2FP12X120	SH2FP16X120	SH2FP18X120	SH2FP24X120

Shutter Board Fabrication Panels

FOR SHAKER-STYLE AND MODERN FARMHOUSE SHAKER-STYLE SHUTTERS

	Individual Sheet Part Number	Width	Length	Thickness
	SHSFP12X144	12"	144"	1-3/8"
	SHSFP16X144	16"	144"	1-3/8"
	SHSFP18X144	18"	144"	1-3/8"
	SHSFP24X144	24"	144"	1-3/8"
	FLT1X3-12	2-1/2"	144"	3/4"

PRO TIP

Fabricate custom shutter designs for a tailored look.





Wood-Grained Shutters



Get the size and style you need.

- Our expanded line includes multiple styles and sizes, with widths measuring 12", 14", 18" and 24" and heights measuring 24"-120" in 1" increments.
- Accessory line of hinges and clavos creates a distinct look for your shutters.
- Stain or paint shutters and shutter accessories.
- Available in both Board & Batten and Plank styles.

BOARD & BATTEN JOINED BOARD AND BATTEN STYLES



2 or 3 Batten

Batten styles with joined boards.



End Batten

Battens are placed at the very end of the boards.



Z Batten

Horizontal and diagonal battens form Z shape.



Quarter Round

Mirrors unique arch top windows.



Elliptical

Mirrors the shape of unique elliptical windows.

PLANK SPACED BOARDS CREATE VISIBILITY OF SIDING BETWEEN SHUTTER BOARDS



2 or 3 Batten

Batten styles with spaced boards.



Z Batten

Horizontal and diagonal battens form Z shape.



Diamond

Decorative diamond shape is centered between the panels.



Elliptical

Mirrors the shape of unique elliptical windows.

BOARD & BATTEN PART NUMBER LOGIC

PLANK PART NUMBER LOGIC

SH3PC18X60RS				SH3PO18X60RS			
[Profile] SH = Shutter		[Texture] RS = Rough Sawn Stain or Paint		[Profile] SH = Shutter		[Texture] RS = Rough Sawn Stain or Paint	
[Configuration] 2PC = 2-Board, 2-Batten 3PC = 3-Board, 2-Batten 4PC = 4-Board, 2-Batten 2P3BC = 2-Board, 3-Batten 3P3BC = 3-Board, 3-Batten 4P3BC = 4-Board, 3-Batten		[Configuration] 2PZC = 2-Board, Z-Batten 3PZC = 3-Board, Z-Batten 4PZC = 4-Board, Z-Batten 2PEBC = 2-Board, End Batten 3PEBC = 3-Board, End Batten 4PEBC = 4-Board, End Batten		[Configuration] 2PO = 2-Plank, 2-Batten 3PO = 3-Plank, 2-Batten 4PO = 4-Plank, 2-Batten 2P3B = 2-Plank, 3-Batten 3P3B = 3-Plank, 3-Batten 4P3B = 4-Plank, 3-Batten		[Configuration] 2PZ = 2-Plank, Z-Batten 3PZ = 3-Plank, Z-Batten 4PZ = 4-Plank, Z-Batten 2PD = 2-Plank, Diamond 3PD = 2-Plank, Diamond 4PD = 2-Plank, Diamond	
[Height] (1" increments) 24 = 24" [Minimum] 120 = 120" [Maximum]		[Height] (1" increments) 24 = 24" [Minimum] 120 = 120" [Maximum]		[Height] (1" increments) 24 = 24" [Minimum] 120 = 120" [Maximum]		[Height] (1" increments) 24 = 24" [Minimum] 120 = 120" [Maximum]	
[Width] 12 = 12" 14 = 14" 18 = 18" 24 = 24"		[Width] 12 = 12" 14 = 14" 18 = 18" 24 = 24"		[Width] 12 = 12" 14 = 14" 18 = 18" 24 = 24"		[Width] 12 = 12" 14 = 14" 18 = 18" 24 = 24"	

QUARTER ROUND PART NUMBER LOGIC

SH3PHLR18X60RS			
[Profile] SH = Shutter		[Texture] RS = Rough Sawn Stain or Paint	
[Configuration] 2PHLR = 2-Board Quarter 3PHLR = 3-Board Quarter 4PHLR = 4-Board Quarter		[Height] (1" increments) 24 = 24" [Minimum] 120 = 120" [Maximum]	
[Width] 12 = 12" 18 = 18" 14 = 14" 24 = 24"			

Note: Minimum height for Quarter Round shutters is double the width of the shutter.

Example: SH3PHLR18x36RS – 18" = width of shutter and 36" = height (twice the width).

Board & Batten Shutters – 2-Batten

ROUGH SAWN CEDAR



12" 2-Board, 2-Batten	14" 3-Board, 2-Batten	18" 3-Board, 2-Batten	24" 4-Board, 2-Batten
SH2PC12X24RS	SH3PC14X24RS	SH3PC18X24RS	SH4PC24X24RS
SH2PC12X36RS	SH3PC14X36RS	SH3PC18X36RS	SH4PC24X36RS
SH2PC12X48RS	SH3PC14X48RS	SH3PC18X48RS	SH4PC24X48RS
SH2PC12X60RS	SH3PC14X60RS	SH3PC18X60RS	SH4PC24X60RS
SH2PC12X72RS	SH3PC14X72RS	SH3PC18X72RS	SH4PC24X72RS
SH2PC12X84RS	SH3PC14X84RS	SH3PC18X84RS	SH4PC24X84RS
SH2PC12X96RS	SH3PC14X96RS	SH3PC18X96RS	SH4PC24X96RS
SH2PC12X108RS	SH3PC14X108RS	SH3PC18X108RS	SH4PC24X108RS
SH2PC12X120RS	SH3PC14X120RS	SH3PC18X120RS	SH4PC24X120RS

Part numbers shown reflect common sizes. For additional options, follow the part number logic below or contact your Fypon® representative.

SH2PC12X24RS

<p>[Profile] SH = Shutter</p>	<p>[Configuration] 2PC = 2-Board, 2-Batten 3PC = 3-Board, 2-Batten 4PC = 4-Board, 2-Batten</p>	<p>[Width] 12 = 12" 14 = 14" 18 = 18" 24 = 24"</p>	<p>[Texture] RS = Rough Sawn</p> <p>[Height] (1" Increments) 24 = 24" [Minimum] 120 = 120" [Maximum]</p>
--	---	---	--





Board & Batten Shutters – 3-Batten

ROUGH SAWN CEDAR



12" 2-Board, 3-Batten	14" 3-Board, 3-Batten	18" 3-Board, 3-Batten	24" 4-Board, 3-Batten
SH2P3BC12X24RS	SH3P3BC14X24RS	SH3P3BC18X24RS	SH4P3BC24X24RS
SH2P3BC12X36RS	SH3P3BC14X36RS	SH3P3BC18X36RS	SH4P3BC24X36RS
SH2P3BC12X48RS	SH3P3BC14X48RS	SH3P3BC18X48RS	SH4P3BC24X48RS
SH2P3BC12X60RS	SH3P3BC14X60RS	SH3P3BC18X60RS	SH4P3BC24X60RS
SH2P3BC12X72RS	SH3P3BC14X72RS	SH3P3BC18X72RS	SH4P3BC24X72RS
SH2P3BC12X84RS	SH3P3BC14X84RS	SH3P3BC18X84RS	SH4P3BC24X84RS
SH2P3BC12X96RS	SH3P3BC14X96RS	SH3P3BC18X96RS	SH4P3BC24X96RS
SH2P3BC12X108RS	SH3P3BC14X108RS	SH3P3BC18X108RS	SH4P3BC24X108RS
SH2P3BC12X120RS	SH3P3BC14X120RS	SH3P3BC18X120RS	SH4P3BC24X120RS

Part numbers shown reflect common sizes. For additional options, follow the part number logic below or contact your Fypon® representative.

SH2P3BC12X24RS

<p>[Profile] SH = Shutter</p>		<p>[Texture] RS = Rough Sawn</p>
<p>[Configuration] 2P3BC = 2-Board, 3-Batten 3P3BC = 3-Board, 3-Batten 4P3BC = 4-Board, 3-Batten</p>	<p>[Width] 12 = 12" 14 = 14" 18 = 18" 24 = 24"</p>	<p>[Height] (1" Increments) 24 = 24" [Minimum] 120 = 120" [Maximum]</p>

Board & Batten Shutters – End Batten

ROUGH SAWN CEDAR



12" 2-Board, End Batten	14" 3-Board, End Batten	18" 3-Board, End Batten	24" 4-Board, End Batten
SH2PEBC12X24RS	SH3PEBC14X24RS	SH3PEBC18X24RS	SH4PEBC24X24RS
SH2PEBC12X36RS	SH3PEBC14X36RS	SH3PEBC18X36RS	SH4PEBC24X36RS
SH2PEBC12X48RS	SH3PEBC14X48RS	SH3PEBC18X48RS	SH4PEBC24X48RS
SH2PEBC12X60RS	SH3PEBC14X60RS	SH3PEBC18X60RS	SH4PEBC24X60RS
SH2PEBC12X72RS	SH3PEBC14X72RS	SH3PEBC18X72RS	SH4PEBC24X72RS
SH2PEBC12X84RS	SH3PEBC14X84RS	SH3PEBC18X84RS	SH4PEBC24X84RS
SH2PEBC12X96RS	SH3PEBC14X96RS	SH3PEBC18X96RS	SH4PEBC24X96RS
SH2PEBC12X108RS	SH3PEBC14X108RS	SH3PEBC18X108RS	SH4PEBC24X108RS
SH2PEBC12X120RS	SH3PEBC14X120RS	SH3PEBC18X120RS	SH4PEBC24X120RS

Part numbers shown reflect common sizes. For additional options, follow the part number logic below or contact your Fypon® representative.

SH2PEBC12X24RS

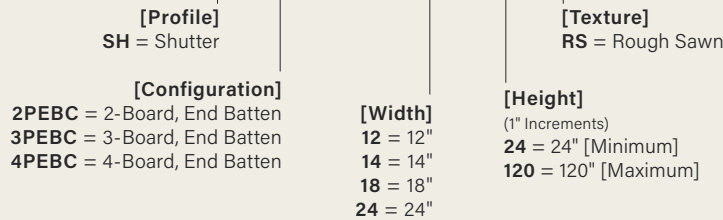





Board & Batten Shutters – Z-Batten

ROUGH SAWN CEDAR



12"	14"	18"	24"
2-Board, Z-Batten	3-Board, Z-Batten	3-Board, Z-Batten	4-Board, Z-Batten
SH2PZC12X24RS	SH3PZC14X24RS	SH3PZC18X24RS	SH4PZC24X24RS
SH2PZC12X36RS	SH3PZC14X36RS	SH3PZC18X36RS	SH4PZC24X36RS
SH2PZC12X48RS	SH3PZC14X48RS	SH3PZC18X48RS	SH4PZC24X48RS
SH2PZC12X60RS	SH3PZC14X60RS	SH3PZC18X60RS	SH4PZC24X60RS
SH2PZC12X72RS	SH3PZC14X72RS	SH3PZC18X72RS	SH4PZC24X72RS
SH2PZC12X84RS	SH3PZC14X84RS	SH3PZC18X84RS	SH4PZC24X84RS
SH2PZC12X96RS	SH3PZC14X96RS	SH3PZC18X96RS	SH4PZC24X96RS
SH2PZC12X108RS	SH3PZC14X108RS	SH3PZC18X108RS	SH4PZC24X108RS
SH2PZC12X120RS	SH3PZC14X120RS	SH3PZC18X120RS	SH4PZC24X120RS

Part numbers shown reflect common sizes. For additional options, follow the part number logic below or contact your Fypon® representative.

SH2PZC12X24RS

<p>[Profile] SH = Shutter</p>	<p>[Width] 12 = 12" 14 = 14" 18 = 18" 24 = 24"</p>	<p>[Texture] RS = Rough Sawn</p>
<p>[Configuration] 2PZC = 2-Board, Z-Batten 3PZC = 3-Board, Z-Batten 4PZC = 4-Board, Z-Batten</p>	<p>[Height] (1" Increments) 24 = 24" [Minimum] 120 = 120" [Maximum]</p>	

Board & Batten Shutters – Quarter Round

ROUGH SAWN CEDAR



12" 2-Board, Quarter Round	14" 3-Board, Quarter Round	18" 3-Board, Quarter Round	24" 4-Board, Quarter Round
SH2PHLR12X24RS	—	—	—
SH2PHLR12X36RS	SH3PHLR14X36RS	SH3PHLR18X36RS	—
SH2PHLR12X48RS	SH3PHLR14X48RS	SH3PHLR18X48RS	SH4PHLR24X48RS
SH2PHLR12X60RS	SH3PHLR14X60RS	SH3PHLR18X60RS	SH4PHLR24X60RS
SH2PHLR12X72RS	SH3PHLR14X72RS	SH3PHLR18X72RS	SH4PHLR24X72RS
SH2PHLR12X84RS	SH3PHLR14X84RS	SH3PHLR18X84RS	SH4PHLR24X84RS
SH2PHLR12X96RS	SH3PHLR14X96RS	SH3PHLR18X96RS	SH4PHLR24X96RS
SH2PHLR12X108RS	SH3PHLR14X108RS	SH3PHLR18X120RS	SH4PHLR24X108RS
SH2PHLR12X120RS	SH3PHLR14X120RS	SH3PHLR18X120RS	SH4PHLR24X120RS

Part numbers shown reflect common sizes. For additional options, follow the part number logic below or contact your Fypon® representative.

SH2PHLR12X24RS

[Profile] SH = Shutter		[Texture] RS = Rough Sawn
[Configuration] 2PHLR = 2-Board, Quarter Round 3PHLR = 3-Board, Quarter Round 4PHLR = 4-Board, Quarter Round	[Width] 12 = 12" 14 = 14" 18 = 18" 24 = 24"	[Height] (1" Increments) 24 = 24" [Minimum] 120 = 120" [Maximum]

Note: Minimum height for Quarter Round shutters is double the width of the shutter.

SH2PHLR14X28RS - 14" = width of shutter and 28" = height (twice the width).



Elliptical Shutters – Board & Batten

ROUGH SAWN CEDAR



PART NUMBER LOGIC

SH3PEHLR18X50X54RS

[Profile]
SH =
Shutter

[Width]

[Height]
H1

[Configuration]

2PEHLR = 2-Board Elliptical
3PEHLR = 3-Board Elliptical
4PEHLR = 4-Board Elliptical

[Texture]
RS = Rough
Sawn Stain
or Paint

[Height]
H2 = (Maximum 120")

Note: Minimum height (H2) for Elliptical Board & Batten shutters is double the width of the shutter.
Example: SH3PEHLR18X35X36RS – 18" = width of shutter and 36" = height (twice the width).
If a specific radius is required to complement an elliptical-shaped window, contact your customer service representative to order.

To order an Elliptical Board & Batten shutter that complements the arch of the window, provide measurements of **H1** (in ¼" increments) and **H2** (in 1" increments) in your part number. See drawing for specific measurement points.

EXAMPLE

SH3PEHLR18X50X54RS

W H1 H2

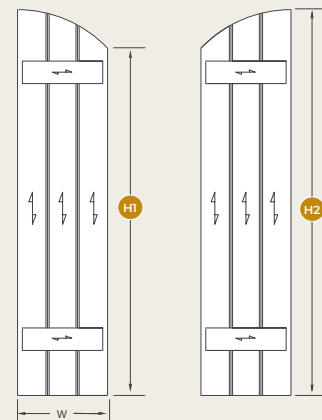

Plank Shutters – 2-Batten

ROUGH SAWN CEDAR



12" 2-Board, 2-Batten	18" 3-Board, 2-Batten	24" 4-Board, 2-Batten
SH2PO12X24RS	SH3PO18X24RS	SH4PO24X24RS
SH2PO12X36RS	SH3PO18X36RS	SH4PO24X36RS
SH2PO12X48RS	SH3PO18X48RS	SH4PO24X48RS
SH2PO12X60RS	SH3PO18X60RS	SH4PO24X60RS
SH2PO12X72RS	SH3PO18X72RS	SH4PO24X72RS
SH2PO12X84RS	SH3PO18X84RS	SH4PO24X84RS
SH2PO12X96RS	SH3PO18X96RS	SH4PO24X96RS
SH2PO12X108RS	SH3PO18X108RS	SH4PO24X108RS
SH2PO12X120RS	SH3PO18X120RS	SH4PO24X120RS

Part numbers shown reflect common sizes. For additional options, follow the part number logic below or contact your Fypon® representative.

SH2PO12X24RS

[Profile]
SH = Shutter

[Configuration]
2PO = 2-Board, 2-Batten
3PO = 3-Board, 2-Batten
4P3O = 4-Board, 2-Batten

[Width]
12 = 12"
18 = 18"
24 = 24"

[Texture]
RS = Rough Sawn

[Height]
(1" Increments)
24 = 24" [Minimum]
120 = 120" [Maximum]



Plank Shutters – 3-Batten

ROUGH SAWN CEDAR



12" 2-Board, 3-Batten	18" 3-Board, 3-Batten	24" 4-Board, 3-Batten
SH2P3B12X24RS	SH3P3B18X24RS	SH4P3B24X24RS
SH2P3B12X36RS	SH3P3B18X36RS	SH4P3B24X36RS
SH2P3B12X48RS	SH3P3B18X48RS	SH4P3B24X48RS
SH2P3B12X60RS	SH3P3B18X60RS	SH4P3B24X60RS
SH2P3B12X72RS	SH3P3B18X72RS	SH4P3B24X72RS
SH2P3B12X84RS	SH3P3B18X84RS	SH4P3B24X84RS
SH2P3B12X96RS	SH3P3B18X96RS	SH4P3B24X96RS
SH2P3B12X108RS	SH3P3B18X108RS	SH4P3B24X108RS
SH2P3B12X120RS	SH3P3B18X120RS	SH4P3B24X120RS

Part numbers shown reflect common sizes. For additional options, follow the part number logic below or contact your Fypon® representative.

SH2P3B12X24RS

<p>[Profile] SH = Shutter</p>	<p>[Configuration] 2P3B = 2-Board, 2-Batten 3P3B = 3-Board, 2-Batten 4P3B = 4-Board, 2-Batten</p>	<p>[Width] 12 = 12" 18 = 18" 24 = 24"</p>	<p>[Texture] RS = Rough Sawn</p>	<p>[Height] (1" Increments) 24 = 24" [Minimum] 120 = 120" [Maximum]</p>
--	--	--	---	--

Plank Shutters – Z-Batten

ROUGH SAWN CEDAR



12" 2-Board, Z-Batten	18" 3-Board, Z-Batten	24" 4-Board, Z-Batten
SH2PZ12X24RS	SH3PZ18X24RS	SH4PZ24X24RS
SH2PZ12X36RS	SH3PZ18X36RS	SH4PZ24X36RS
SH2PZ12X48RS	SH3PZ18X48RS	SH4PZ24X48RS
SH2PZ12X60RS	SH3PZ18X60RS	SH4PZ24X60RS
SH2PZ12X72RS	SH3PZ18X72RS	SH4PZ24X72RS
SH2PZ12X84RS	SH3PZ18X84RS	SH4PZ24X84RS
SH2PZ12X96RS	SH3PZ18X96RS	SH4PZ24X96RS
SH2PZ12X108RS	SH3PZ18X108RS	SH4PZ24X108RS
SH2PZ12X120RS	SH3PZ18X120RS	SH4PZ24X120RS

Part numbers shown reflect common sizes. For additional options, follow the part number logic below or contact your Fypon® representative.

SH2PZ12X24RS

<p>[Profile] SH = Shutter</p>	<p>[Configuration] 2PZ = 2-Board, Z-Batten 3PZ = 3-Board, Z-Batten 4PZ = 4-Board, Z-Batten</p>	<p>[Texture] RS = Rough Sawn</p>
	<p>[Width] 12 = 12" 18 = 18" 24 = 24"</p>	<p>[Height] (1" Increments) 24 = 24" [Minimum] 120 = 120" [Maximum]</p>

Plank Shutters – Diamond

ROUGH SAWN CEDAR



12" 2-Board, Diamond	18" 3-Board, Diamond	24" 4-Board, Diamond
SH2PD12X24RS	SH3PD18X24RS	SH4PD24X24RS
SH2PD12X36RS	SH3PD18X36RS	SH4PD24X36RS
SH2PD12X48RS	SH3PD18X48RS	SH4PD24X48RS
SH2PD12X60RS	SH3PD18X60RS	SH4PD24X60RS
SH2PD12X72RS	SH3PD18X72RS	SH4PD24X72RS
SH2PD12X84RS	SH3PD18X84RS	SH4PD24X84RS
SH2PD12X96RS	SH3PD18X96RS	SH4PD24X96RS
SH2PD12X108RS	SH3PD18X108RS	SH4PD24X108RS
SH2PD12X120RS	SH3PD18X120RS	SH4PD24X120RS

Part numbers shown reflect common sizes. For additional options, follow the part number logic below or contact your Fypon® representative.

SH2PD12X24RS

[Profile] SH = Shutter		[Texture] RS = Rough Sawn
[Configuration] 2PD = 2-Board, Diamond 3PD = 3-Board, Diamond 4PD = 4-Board, Diamond	[Width] 12 = 12" 18 = 18" 24 = 24"	[Height] (1" Increments) 24 = 24" [Minimum] 120 = 120" [Maximum]



Elliptical Shutters – Plank

ROUGH SAWN CEDAR



PART NUMBER LOGIC

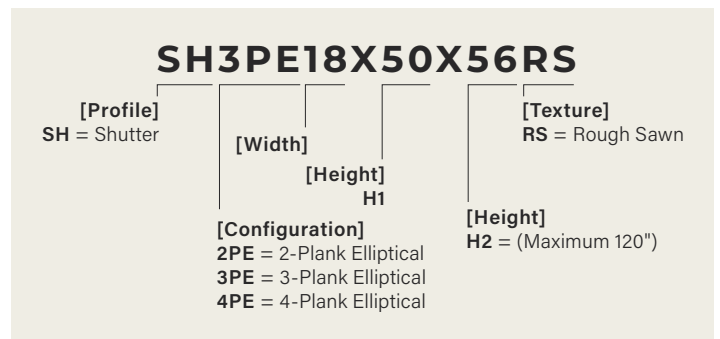

Note: Minimum height (H2) for Elliptical Plank shutters is double the width of the shutter.

Example: SH3PE18X35X36RS – 18" = width of shutter and 36" = height (twice the width).

If a specific radius is required to complement an elliptical-shaped window, contact your customer service representative to order.

To order an Elliptical Plank shutter that complements the arch of the window, provide measurements of **H1** (in 1/4" increments) and **H2** (in 1" increments) in your part number. See drawing for specific measurement points.

EXAMPLE

SH3PE18X50X56RS

W H1 H2

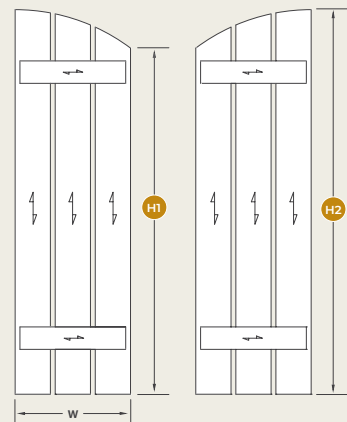

Double Raised Panel Shutter

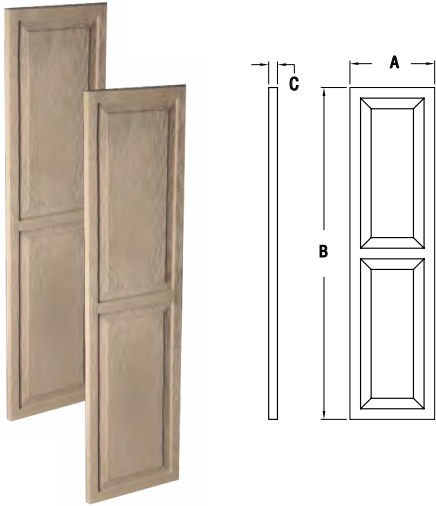



ROUGH SAWN CEDAR

Part Number	Width (A)	Height (B)	Projection (C)
SH16X48DPS	16"	48"	1-1/4"
SH16X60DPS	16"	60"	1-1/4"
SH18X72DPS	18"	72"	1-1/4"



Wood-Grained Shutter Board Fabrication Panels Plank Shutters – Diamond

ROUGH SAWN CEDAR

	Individual Sheet Part Number	Width	Length	Thickness
	SHBB14X144RS 3-Board Panel	14"	144"	3/4"
	SHBB18X144RS 3-Board Panel	18"	144"	3/4"
	FLT1X4-12RS ¹ Batten Trim	3-1/2"	144"	3/4"

Shutter Accessories — Hinges

COLONIAL & SPEAR

	Part Number	Length
	SHHNGSPR10 ²	10"
	SHHNGSPR16 ²	16"



¹Sold as a four pack. | ²Sold as a set.
Note: Shutters sold as a set. Shutter accessories come primed and ready for paint.

Craftsman Cove Crosshead



HOW TO ORDER

- 1 Determine height.
- 2 Determine breast board width. When installing over side trim CHCCC6X9BT-5 coordinates best with 5-1/2" pilaster and 5-1/2" wide trim.
- 3 Select end cap width.



Trimable

- Our Craftsman Cove crosshead line includes a 9" height, measuring 36", 48", 144" and 216".
- End caps do not come standard with trimmable product. They must be ordered. 3-1/2" or 5-1/2" end caps are optional; complement standard trim widths.
- End caps overlap crosshead.
- Crosshead and end caps may be routed.

9" Craftsman Cove Crosshead

TRIMMABLE



Trimable

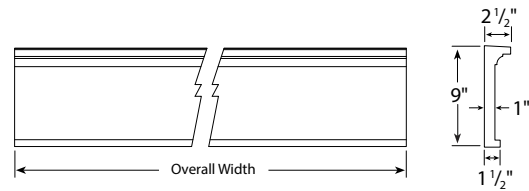

Part Number (Qty 2)	Overall Width
CHCCT36X9BT	36"
CHCCT48X9BT	48"
CHCCT144X9BT	144"
CHCCT216X9BT	216"

9" Craftsman Cove End Caps



3-1/2" End Caps



5-1/2" End Caps

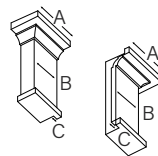

Bottom View

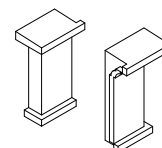

Top View

Part Number (Qty 2)	Overall Width (A)	Width (B)	Rabbet Width (C)
CHCCC4X9BT-5 ¹	5"	3-1/2"	1/2"
CHCCC6X9BT-5 ¹	7"	5-1/2"	1/2"

¹Pack quantity of five pair (10 pieces total).
Note: End cap overlaps the trimmable crosshead.

Distinction Crosshead



Trimmable

- Distinction trimmable crossheads are available in heights measuring 6" and 9", and widths measuring 36", 48", 144" and 216".
 - 36" and 48" widths allow for ease of handling and quick installation.
 - 144" and 216" widths can be cut to any length, minimizing waste in the field.
- End caps overlap the trimmable crosshead.
- End caps may be routed.

6" & 9" Distinction Crosshead



TRIMMABLE



6" Height		9" Height		Overall Width
CHT36X6		CHT36X9		36"
CHT48X6		CHT48X9		48"
CHT144X6		CHT144X9		144- ³ / ₈ "
CHT216X6		CHT216X9		216- ⁵ / ₈ "

End Caps



1-¹/₂" End Cap



3-¹/₂" End Cap



7" End Cap



11" End Cap

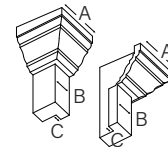

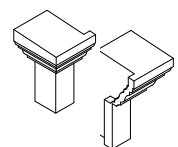

Bottom View



Top View

6" Height			9" Height				
Qty 1	Qty 5	Overall Width (A)	Qty 1	Qty 5	Overall Width (A)	Breast Board Width (B)	Rabbit Width (C)
CHC2X6	CHC2X6-5	3- ¹ / ₄ "	—	CHC2X9-5	4- ¹ / ₄ "	1- ¹ / ₂ "	¹ / ₂ "
—	CHC4X6-5	5- ¹ / ₄ "	—	—	6- ¹ / ₄ "	3- ¹ / ₂ "	1"
CHC7X6 ¹	CHC7X6-5*	8- ³ / ₄ "	CHC7X9 ¹	CHC7X9-5 ¹	9- ³ / ₄ "	7"	4"
CHC11X6 ¹	—	12- ³ / ₄ "	CHC11X9 ¹	—	13- ³ / ₄ "	11"	4"

Distinction Accessories

Accessory	6" Height	9" Height
 Keystone	K6M	K9M
 Dentil	MLD357-8	MLD358-8
 Bottom Trim	MLD716-12	MLD758-12

¹Trimtable up to 3-¹/₂".
Note: End caps are sold in pairs.

Craftsman Step Crosshead



6" Craftsman Step Crosshead

TRIMMABLE



Trimmable

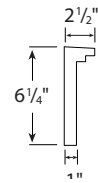
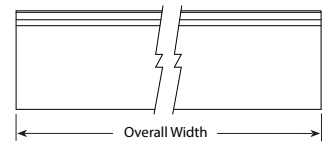
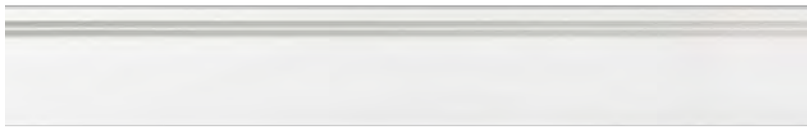

Part Number	Overall Width	Height
CHCST36X6	36"	6-1/4"
CHCST48X6	48"	6-1/4"
CHCST144X6	144-3/8"	6-1/4"
CHCST216X6	216-5/8"	6-1/4"

8" Craftsman Step Crosshead

TRIMMABLE



Trimmable

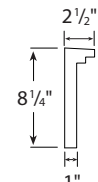
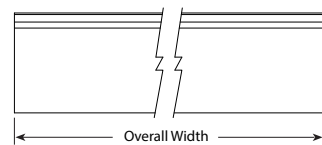
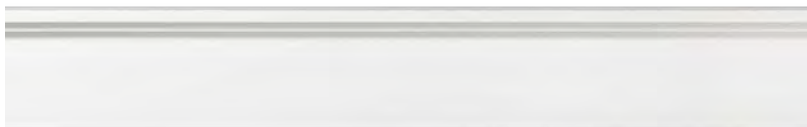

Part Number	Overall Width	Height
CHCST36X8	36"	8-1/4"
CHCST48X8	48"	8-1/4"
CHCST144X8	144-3/8"	8-1/4"
CHCST216X8	216-5/8"	8-1/4"



Classic Crosshead



6" Classic Crosshead

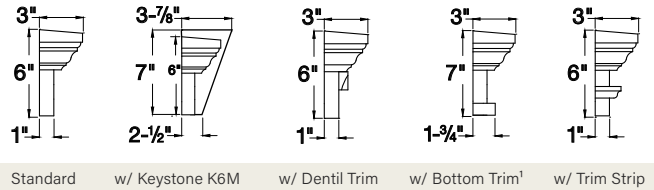

Part Number	Width	Overall Width
WCH24X6	24"	27-1/2"
WCH28X6	28"	31-1/2"
WCH30X6	30"	33-1/2"
WCH31X6	31"	34-1/2"
WCH32X6	32"	35-1/2"
WCH33X6	33"	36-1/2"
WCH34X6	34"	37-1/2"
WCH35X6	35"	38-1/2"
WCH36X6	36"	39-1/2"
WCH37X6	37"	40-1/2"
WCH38X6	38"	41-1/2"
WCH40X6	40"	43-1/2"
WCH41X6	41"	44-1/2"
WCH43X6	43"	46-1/2"
WCH44X6	44"	47-1/2"
WCH46X6	46"	49-1/2"
WCH47X6	47"	50-1/2"
WCH48X6	48"	51-1/2"
WCH50X6	50"	53-1/2"
WCH51X6	51"	54-1/2"
WCH52X6	52"	55-1/2"
WCH54X6	54"	57-1/2"
WCH56X6	56"	59-1/2"

Part Number	Width	Overall Width
WCH60X6	60"	63-1/2"
WCH64X6	64"	67-1/2"
WCH66X6	66"	69-1/2"
WCH67X6	67"	70-1/2"
WCH68X6	68"	71-1/2"
WCH72X6	72"	75-1/2"
WCH73X6	73"	76-1/2"
WCH74X6	74"	77-1/2"
WCH76X6	76"	79-1/2"
WCH78X6	78"	81-1/2"
WCH79X6	79"	82-1/2"
WCH80X6	80"	83-1/2"
WCH80.5X6	80-1/2"	84"
WCH84X6	84"	87-1/2"
WCH86X6	86"	89-1/2"
WCH87X6	87"	90-1/2"
WCH96X6	96"	99-1/2"
WCH100X6	100"	103-1/2"
WCH103X6	103"	106-1/2"
WCH104X6	104"	107-1/2"
WCH108X6	108"	111-1/2"
WCH110X6	110"	113-1/2"
WCH144X6	144"	147-1/2"

PART NUMBER LOGIC

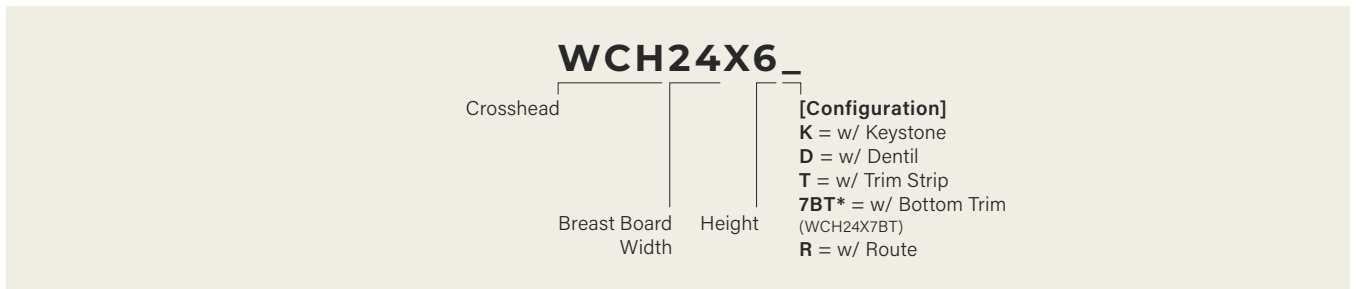

*Bottom trim adds 1" to overall height.

9" Classic Crosshead

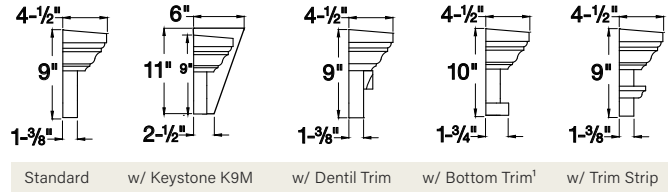
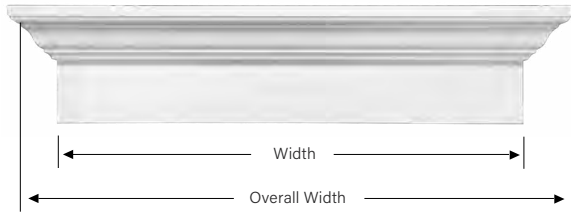

Part Number	Width	Overall Width
WCH20X9	20"	25-1/2"
WCH24X9	24"	29-1/2"
WCH25X9	25"	30-1/2"
WCH26X9	26"	31-1/2"
WCH27X9	27"	32-1/2"
WCH28X9	28"	33-1/2"
WCH29X9	29-5/8"	35-1/8"
WCH30X9	30-1/4"	35-3/4"
WCH32X9	32"	37-1/2"
WCH33X9	33"	38-1/2"
WCH34X9	34"	39-1/2"
WCH35X9	35"	40-1/2"
WCH36X9	36"	41-1/2"
WCH37X9	37"	42-1/2"
WCH38X9	38"	43-1/2"
WCH40X9	40"	45-1/2"
WCH41X9	41"	46-1/2"
WCH42X9	42"	47-1/2"
WCH43X9	43"	48-1/2"
WCH44X9	44"	49-1/2"
WCH45X9	45"	50-1/2"
WCH46X9	46"	51-1/2"

Part Number	Width	Overall Width
WCH48X9	48"	53-1/2"
WCH49X9	49"	54-1/2"
WCH50X9	50"	55-1/2"
WCH54X9	54"	59-1/2"
WCH56X9	56"	61-1/2"
WCH58X9	58"	63-1/2"
WCH60X9	60"	65-1/2"
WCH62X9	62"	67-1/2"
WCH64X9	64"	69-1/2"
WCH65X9	65"	70-1/2"
WCH66X9	66"	71-1/2"
WCH67X9	67"	72-1/2"
WCH68X9	68"	73-1/2"
WCH69X9	69"	74-1/2"
WCH70X9	70"	75-1/2"
WCH72X9	72"	77-1/2"
WCH73X9	73"	78-1/2"
WCH74X9	74"	79-1/2"
WCH75X9	75"	80-1/2"
WCH76X9	76"	81-1/2"
WCH77X9	77"	82-1/2"
WCH78X9	78"	83-1/2"

PART NUMBER LOGIC

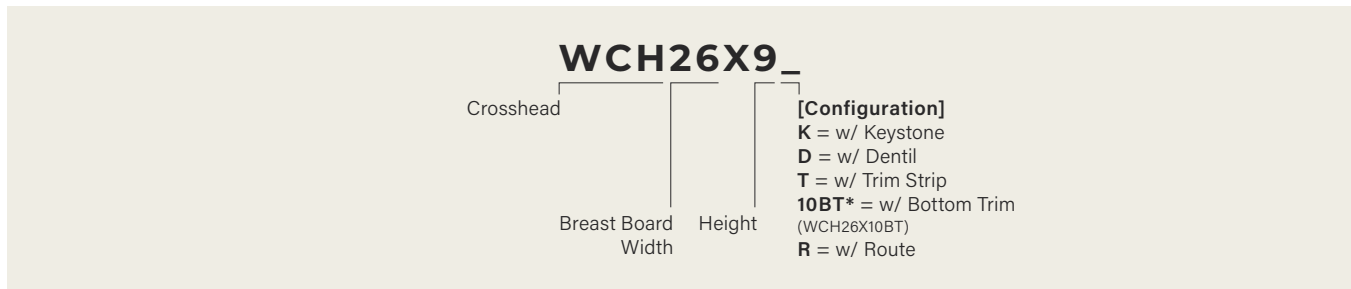



Part Number	Width	Overall Width
WCH80X9	80"	85-1/2"
WCH81X9	81"	86-1/2"
WCH82X9	82"	87-1/2"
WCH84X9	84"	89-1/2"
WCH85X9	85"	90-1/2"
WCH86X9	86"	91-1/2"
WCH88X9	88"	93-1/2"
WCH90X9	90"	95-1/2"
WCH93X9	93"	98-1/2"
WCH96X9	96"	101-1/2"
WCH99X9	99"	104-1/2"
WCH100X9	100"	105-1/2"
WCH101X9	101"	106-1/2"
WCH103X9	103"	108-1/2"

Part Number	Width	Overall Width
WCH104X9	104"	109-1/2"
WCH108X9	108"	113-1/2"
WCH110X9	110"	115-1/2"
WCH112X9	112"	117-1/2"
WCH113X9	113"	118-1/2"
WCH120X9	120"	125-1/2"
WCH124X9	124"	129-1/2"
WCH144X9	144"	149-1/2"
WCH192X9	192"	197-1/2"
WCH196X9	196"	201-1/2"
WCH197X9	197"	202-1/2"
WCH200X9	200"	205-1/2"
WCH204X9	204"	209-1/2"
WCH207X9	207"	212-1/2"





12" Classic Crosshead

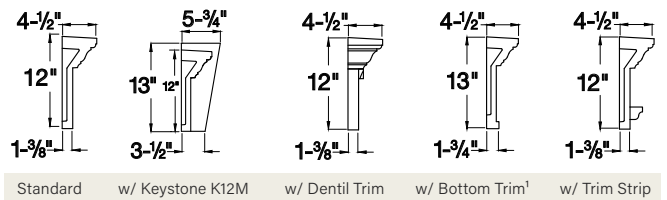
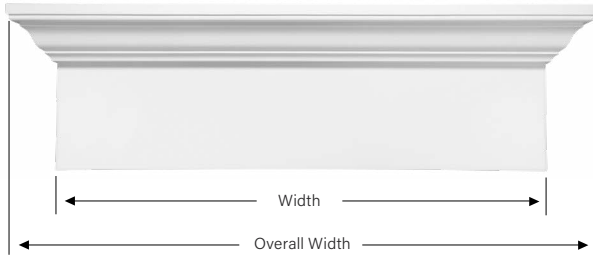

Part Number	Width	Overall Width
WCH36X12	36"	41-1/2"
WCH40X12	40"	45-1/2"
WCH44X12	44"	49-1/2"
WCH48X12	48"	53-1/2"
WCH54X12	54"	59-1/2"
WCH56X12	56"	61-1/2"
WCH64X12	64"	69-1/2"
WCH72X12	72"	77-1/2"

Part Number	Width	Overall Width
WCH96X12	96"	101-1/2"
WCH102X12	102"	107-1/2"
WCH104X12	104"	109-1/2"
WCH144X12	144"	149-1/2"
WCH200X12	200"	205-1/2"
WCH203X12	203"	208-1/2"
WCH213X12	213"	218-1/2"

PART NUMBER LOGIC

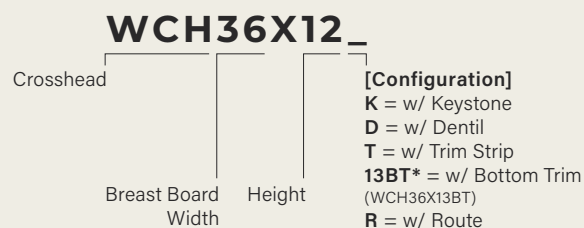

¹Bottom trim adds 1" to overall height.

6" Crosshead Arch

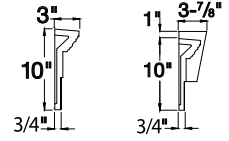
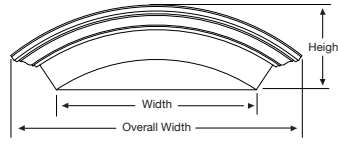

Standard w/ Keystone K6M

Part Number	Part Number w/ Keystone	Width	Overall Width	Height
WCH6ARS34X10	WCH6ARS34X10K	34"	42-7/8"	10"

9" Crosshead Arch

SOLID

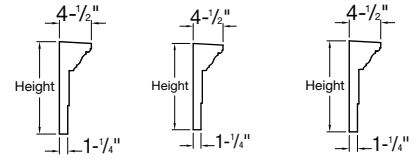
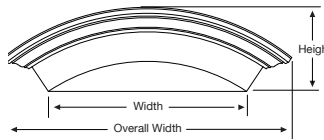

Standard w/ Keystone K9M w/ Bottom Trim¹

Part Number	Width	Overall Width	Height
WCHARS33X14	33"	48-1/8"	14"
WCHARS36X13	36"	49-1/4"	13"
WCHARS43X13	43"	55-1/4"	13"
WCHARS54X16	54"	68-1/8"	16"
WCHARS64X14	64"	75-1/2"	14"
WCHARS68X12	68"	77-1/4"	12"
WCHARS68X16	68"	80-7/8"	16"
WCHARS72X13	72"	82-1/8"	13"
WCHARS75X13	75"	84-7/8"	13-3/8"
WCHARS80X15	80"	91-1/4"	15"
WCHARS84X16	84"	95-3/4"	16"
WCHARS89X13	89"	98-3/8"	13"
WCHARS97X17	97"	108-3/4"	17"
WCHARS101X13	101"	110"	13"
WCHARS108X19	108"	119-7/8"	19-1/4"

PART NUMBER LOGIC

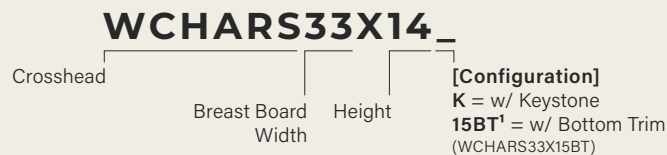

10" Eyebrow Crosshead

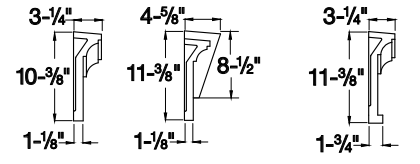
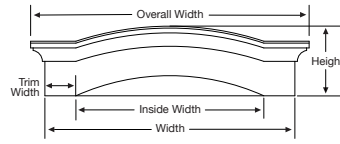

Standard w/ Keystone K10SEG w/ Bottom Trim¹

Part Number	Width	Inside Width	Overall Width
WCHSEG28X10	37-1/4"	28"	41-1/2"
WCHSEG30X10	39-1/8"	29-7/8"	43-3/8"
WCHSEG34X10	44"	34"	48-1/4"
WCHSEG36X10	45"	36"	49-1/4"
WCHSEG43X10	48"	43"	52-1/4"
WCHSEG44X10	49"	44"	53-1/4"
WCHSEG64X10	73-1/4"	64"	77-1/2"
WCHSEG72X10	81"	72"	85-1/4"

Large Door Crosshead

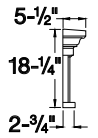
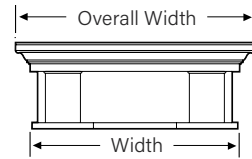

Standard

Part Number	Width	Overall Width	Pediment	Pilaster
LDCH58X18	58"	67-1/2"	AP667, SP667	All 11" Pilasters
LDCH62X18	62"	71-1/2"	AP667, SP667	
LDCH87X18	87"	96-1/2"	—	
LDCH90X18	90-1/2"	100"	—	
LDCH94X18	94-1/2"	104"	—	

PART NUMBER LOGIC





Half-Round Spoked Pediment

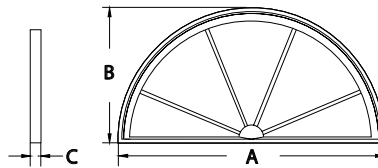

Part Number	Width (A)	Height (B)	Projection (C)	Flat Trim	Decorative Trim
HRSP36X18	36"	18"	1-3/4"	AR36X4F AR36X6F	AR36X4M, AR36X6M, AR36X10MC

Segment Sunburst

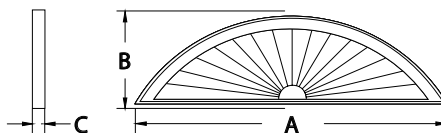

Part Number	Width (A)	Height (B)	Projection (C)
SWDH36X9	36"	9"	1-3/4"
SWDH48X13	48"	13"	1-3/4"
SWDH68X14	67-5/8"	14"	1-3/4"
SWDH72X14	72"	14"	1-3/4"
SWDH76X15	76"	15"	1-3/4"
SWDH80X15	79-1/2"	15"	1-3/4"

Half-Round Sunburst

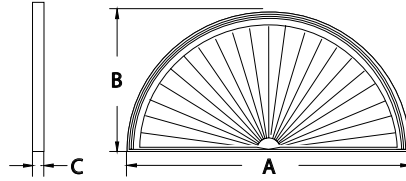

Part Number	Width (A)	Height (B)	Projection (C)	Flat Trim	Decorative Trim
SWDH24X12	24"	12"	1-3/4"	AR24X4F	—
SWDH28X14	28"	14"	1-3/4"	—	—
SWDH30X15	30"	15"	1-3/4"	—	—
SWDH32X16	32"	16"	1-3/4"	—	—
SWDH33X17	33-5/8"	161-3/4"	1-3/4"	—	—
SWDH36X18	36"	18"	1-3/4"	AR36X4F AR36X6F	AR36X4M, AR36X6M AR36X10MC
SWDH37X19	37-5/8"	181-3/4"	1-3/4"	AR37X4F	—
SWDH40X20	40"	20"	1-3/4"	—	AR40X6M
SWDH42X21	42"	21"	1-3/4"	—	—
SWDH44X22	44"	22"	1-3/4"	—	—
SWDH48X24	48"	24"	1-3/4"	AR48X4F AR48X6F	AR48X4M AR48X6M
SWDH56X28	56"	28"	1-3/4"	—	—
SWDH60X30	60"	30"	1-3/4"	—	AR60X6M
SWDH64X32	64"	32"	1-3/4"	—	AR64X10MC
SWDH68X34	68"	34"	1-3/4"	—	—
SWDH72X36	72"	36"	1-3/4"	AR72X4F	AR72X6M
SWDH76X38	76"	38"	1-3/4"	—	—

Half-Round Sunburst

WITH FLAT TRIM & KEYSTONE

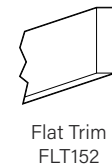
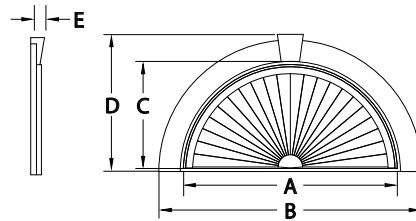
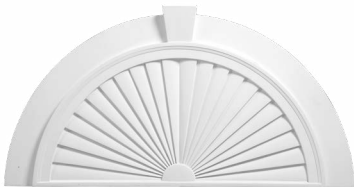

Part Number	Width (A)	Overall Width (B)	Height (C)	Overall Height (D)	Projection (E)
SWDH36X18-4FK	36"	43"	18"	22-1/2"	2-1/4"

Sunburst Pediment

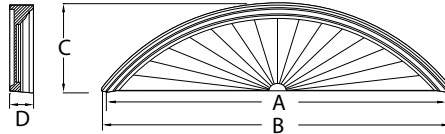

Part Number	Width (A)	Overall Width (B)	Height (C)	Projection (D)	Crosshead
SP56	55- $\frac{1}{4}$ "	57"	16- $\frac{3}{4}$ "	4- $\frac{1}{2}$ "	WCH50X9
SP667	66- $\frac{3}{4}$ "	69- $\frac{1}{4}$ "	20- $\frac{3}{8}$ "	5- $\frac{1}{2}$ "	LDCH58X18 LDCH62X18
SP91	90- $\frac{1}{2}$ "	92- $\frac{1}{2}$ "	26"	4- $\frac{1}{2}$ "	WCH86X9

Combination Sunburst Pediment

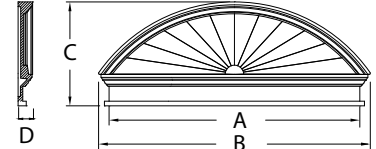
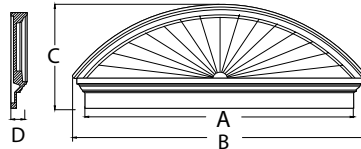

Part Number	Width (A)	Overall Width (B)	Height (C)	Projection (D)	Breast Board Thickness	Part Number w/ Bottom Trim ¹
CSP54	54"	58- $\frac{1}{2}$ "	21- $\frac{3}{8}$ "	3- $\frac{1}{8}$ "	1"	CSP54BT
CSP80	80"	84- $\frac{5}{8}$ "	25- $\frac{1}{2}$ "	3- $\frac{1}{8}$ "	1"	—
CSP85	85"	89- $\frac{1}{2}$ "	26- $\frac{3}{8}$ "	3- $\frac{1}{8}$ "	1"	—

Combination Segment Arch Pediment

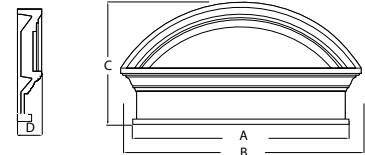
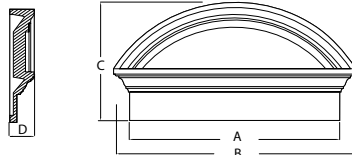

Part Number	Width (A)	Overall Width (B)	Height (C)	Projection (D)
CSAP36	36"	41- $\frac{1}{2}$ "	20"	4- $\frac{1}{2}$ "
CSAP48	48"	53- $\frac{1}{2}$ "	22- $\frac{1}{2}$ "	4- $\frac{1}{2}$ "
CSAP65	65"	70- $\frac{1}{2}$ "	28- $\frac{3}{8}$ "	4- $\frac{1}{2}$ "



GRAPHIC DESIGN REFERENCED | 41
1000 Designs for the garden and where to find them
MAKING IT



Peaked Cap Pediment



Part Number	Overall Width (A)	Overall Height (B)	Projection (C)	Pitch (D)	Crosshead
PCP56	56-1/2"	13-5/8"	4-1/2"	5-1/2 / 12	WCH50X9

Combination Peaked Cap Pediment

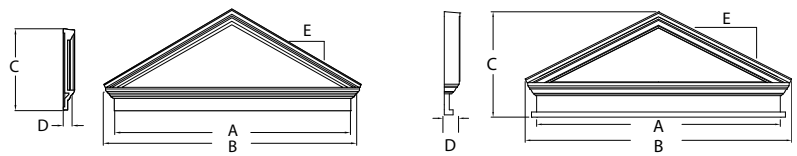

Part Number	Width (A)	Overall Width (B)	Overall Height (C)	Projection (D)	Pitch (E)	Breast Board Thickness	Part Number w/ Bottom Trim ¹
CPCP48	47-1/2"	52"	19-1/2"	3-1/8"	6 / 12	1"	CPCP48BT
CPCP50	50"	54-1/2"	20-1/4"	3-1/8"	6 / 12	1"	CPCP50BT
CPCP54	54"	58-1/4"	21"	3-1/8"	6 / 12	1"	CPCP54BT
CPCP58	58"	62-3/8"	22"	3-1/8"	6 / 12	1"	—
CPCP67	67-1/2"	72"	24-1/2"	3-1/8"	6 / 12	1"	CPCP67BT
CPCP75	75"	79-1/2"	26-1/4"	3-1/8"	6 / 12	1"	CPCP75BT
CPCP80	80"	84-1/2"	27-5/8"	3-1/8"	6 / 12	1"	CPCP80BT
CPCP85	85"	89-1/2"	28-3/4"	3-1/8"	6 / 12	1"	—

Combination Peaked Cap Pediment

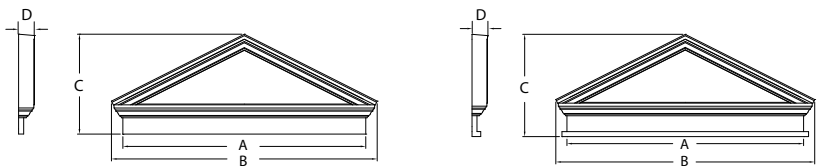

Part Number	Width (A)	Overall Width (B)	Height (C)	Projection (D)
CCP37	37-5/8"	41-3/4"	20-1/2"	4-1/2"

¹Bottom trim adds 1" to overall height.

Acorn Pediment



Note: Acorn ships unattached in carton.

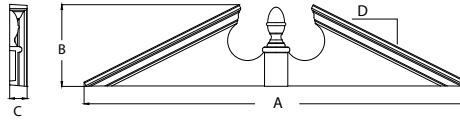

Part Number	Overall Width (A)	Overall Height (B)	Projection (C)	Pitch (D)	Crosshead
AP56	57"	16-5/8"	4-1/2"	6-1/2 / 12	WCH50X9
AP61	62"	17"	4-1/2"	7 / 12	WCH54X9 WCH56X9
AP667	68-7/8"	23-1/4"	5-1/2"	12 / 12	LDCH58X18 LDCH62X18
AP86	87-1/4"	23-1/8"	4-1/2"	7 / 12	WCH81X9
AP91	92-1/8"	24-11/16"	4-1/2"	6 / 12	WCH86X9
AP98	99-1/8"	24-9/16"	4-1/2"	6 / 12	WCH90X9 WCH93X9

Acorn Pediment

ADJUSTABLE

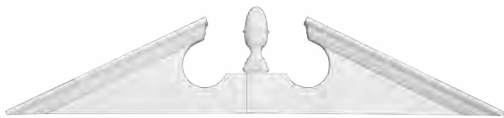

Note: Ships in 4 pieces.

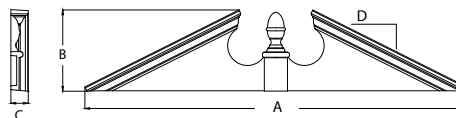

Part Number	Overall Width (A)	Overall Height (B)	Projection (C)	Pitch (D)	Crosshead
AP115	105"-115"	25-5/8"	4-1/2"	6 / 12	9" WCH from 100"-110"

Combination Acorn Pediment



Note: Acorn ships unattached in carton.

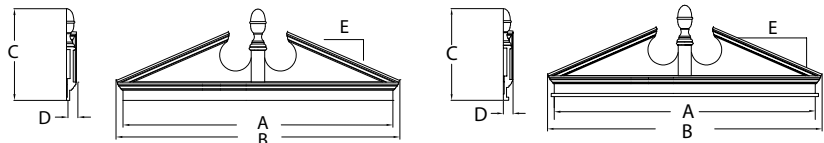

Part Number	Width (A)	Overall Width (B)	Overall Height (C)	Projection (D)	Pitch (E)	Part Number w/ Bottom Trim ¹
CAP47E ²	47"	50-1/8"	13-5/8"	2-1/8"	5 / 12	—
CAP50	50"	54-1/2"	21-1/8"	3-1/8"	6 / 12	—
CAP54	54"	58-1/2"	21-3/8"	3-1/8"	6 / 12	CAP54BT
CAP58	58"	62-1/2"	21-3/4"	3-1/8"	6 / 12	CAP58BT
CAP67	67-1/2"	72"	24-1/8"	3"	6 / 12	CAP67BT
CAP75	75"	79-1/2"	25-1/8"	3-1/8"	6 / 12	CAP75BT
CAP80	80"	84-7/16"	25-3/8"	3-1/8"	5-1/2 / 12	CAP80BT
CAP85	85"	89-3/8"	28-3/4"	3-1/8"	5 / 12	CAP85BT

¹Bottom trim adds 1" to overall height.

²Does not have breast board. Accessories cannot be added.





Combination Rams Head Pediment

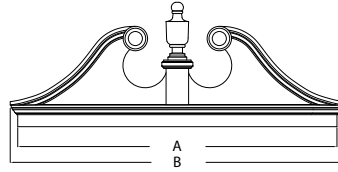
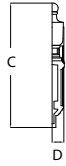
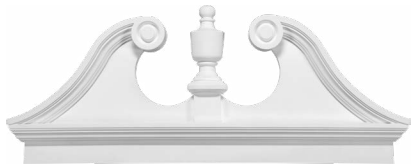

Note: Urn ships unattached in carton.

Part Number	Width (A)	Overall Width (B)	Overall Height (C)	Projection (D)	Breast Board Thickness	Part Number w/ Bottom Trim ¹
CRHP54	54"	58"	23-1/2"	3-1/8"	1"	CRHP54BT
CRHP85	85"	89"	33-5/8"	3-1/8"	1"	—

7" Panel Arch

WITH SUNBURST & KEYSTONE

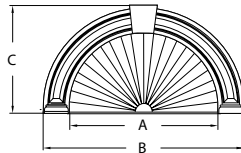
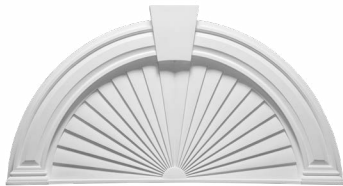

Part Number	Sunburst Width (A)	Overall Width (B)	Height (C)	Radius	Keystone Projection (D)	Pilaster
AR40X54PSK	40"	54"	29"	20"	2-5/8"	PIL7X90DP

Note: PIL7X90DP matches this arch profile only.



¹Bottom trim adds 1" to overall height.

Plain Pilaster

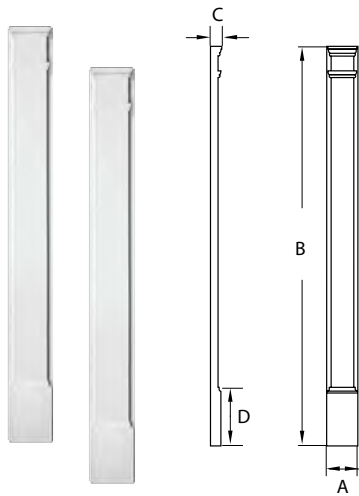

MOLDED WITH PLINTH

Part Number	Width (A)	Height (B)	Projection (C)	Plinth Block Height (D)
PIL5X90P	5-1/4"	90"	1-5/8"	10-1/8"
PIL6X90P	6"	90"	2-1/2"	13-1/4"
PIL7X90P	7"	90"	2-1/2"	13-1/4"
PIL8X90P	8"	90"	2-1/2"	13-1/4"
PIL9X90P	9"	90"	3"	14-1/2"
PIL11X90P	11"	90"	3-1/2"	13-1/4"

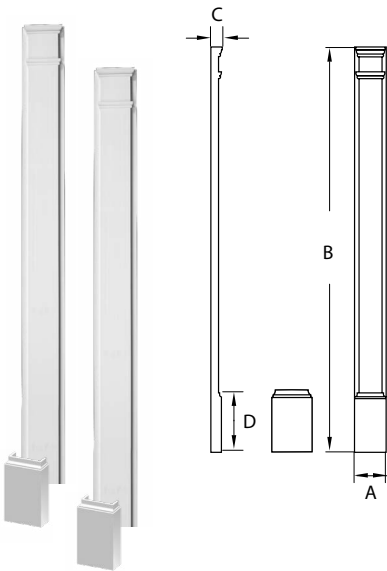

TWO-PIECE ADJUSTABLE

Part Number	Width (A)	Height (B)	Projection (C)	Plinth Block Height (D)
PIL5X108P	5-1/4"	108"	1-5/8"	10"
PIL6X120P	6"	120"	2-1/2"	13-1/4"
PIL7X108P	7"	108"	2-1/2"	13"
PIL7X120P	7"	120"	2-1/2"	13"
PIL8X108P	8"	108"	2-5/8"	13"
PIL9X108P	9"	108"	3"	14-1/2"
PIL9X120P	9"	120"	3"	14-1/2"
PIL10X120P	10"	120"	3-1/4"	14-1/2"
PIL11X96P	11"	96"	3-1/2"	14-1/2"
PIL11X108P	11"	108"	3-1/2"	14-1/2"
PIL11X120P	11"	120"	3-1/2"	14-1/2"



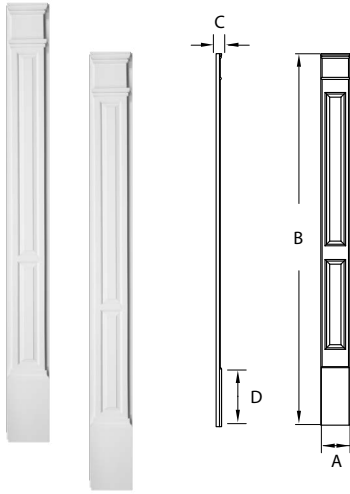

Double Panel Pilaster

MOLDED WITH PLINTH

Part Number	Width (A)	Height (B)	Projection (C)	Plinth Block Height (D)
PIL5X90DP	5-1/4"	90"	1-5/8"	10-1/8"
PIL7X90DP	7"	90"	2-1/2"	13-1/4"
PIL9X90DP	9"	90"	3"	14-1/2"
PIL9X100DP	9"	100"	3"	14-1/2"
PIL11X90DP	11"	90"	3-1/2"	14-1/2"
PIL11X108DP	11"	108"	3-1/2"	14-1/2"

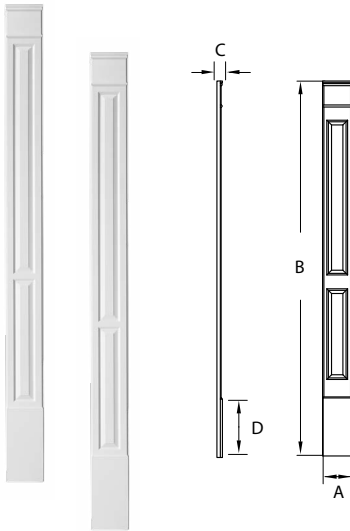

Double Panel Narrow Pilaster

MOLDED WITH PLINTH

Part Number	Width (A)	Height (B)	Projection (C)	Plinth Block Height (D)
PIL7X90DPE	7"	90"	1-1/4"	14-1/4"

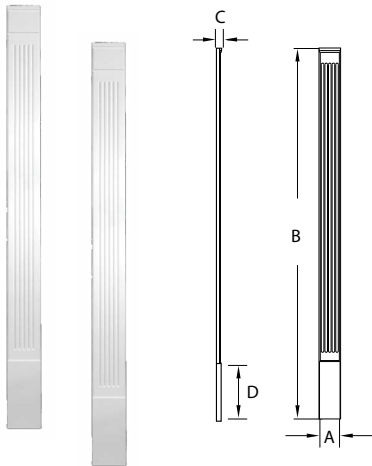

Fluted Narrow Pilaster

MOLDED WITH PLINTH

Part Number	Width (A)	Height (B)	Projection (C)	Plinth Block Height (D)
PIL5X90E	5-1/4"	90"	1-1/4"	14-1/4"
PIL7X90E	7"	90"	1-1/4"	14-1/4"
PIL9X90E	9"	90"	1-1/4"	14-1/4"



Fluted Pilaster

MOLDED WITH PLINTH

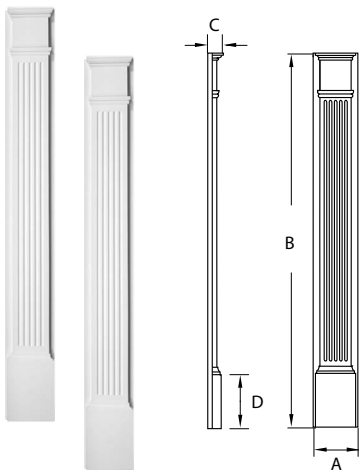

Part Number	Width (A)	Height (B)	Projection (C)	Plinth Block Height (D)
PIL4X83	4-1/2"	82-3/4"	1-5/8"	7-3/4"
PIL4X86	4-1/2"	86"	1-5/8"	11"
PIL4X90	4-1/2"	90"	1-5/8"	10"
PIL5X82	5-1/4"	82"	1-3/4"	8"
PIL5X90	5-1/4"	90"	1-3/4"	10-1/8"
PIL6X90	6-1/4"	90"	2-1/2"	13-1/4"
PIL7X90	7"	90"	2-1/2"	13-1/4"
PIL9X90	9"	90"	3"	14-1/2"
PIL11X90	11"	90"	3-1/2"	14-1/2"

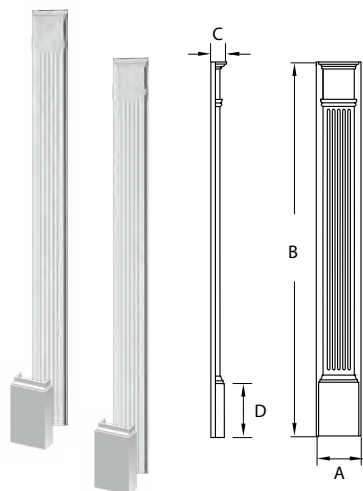

Fluted Pilaster

TWO-PIECE ADJUSTABLE

Part Number	Width (A)	Height (B)	Projection (C)	Plinth Block Height (D)
PIL3X108	3-1/2"	108"	1-5/8"	10"
PIL4X108	4-1/2"	108"	1-5/8"	10"
PIL5X108	5-1/4"	108"	1-5/8"	10"
PIL6X108	6-1/4"	108"	2-1/2"	13-1/4"
PIL6X144	6-1/4"	144"	2-1/2"	13-1/4"
PIL7X102	7"	102"	2-1/2"	13-1/4"
PIL7X108	7"	108"	2-1/2"	13"
PIL7X144	7"	144"	2-1/2"	13"
PIL8X90	8"	90"	2-1/2"	13"
PIL8X108	8"	108"	2-1/2"	13"
PIL8X144	8"	144"	2-1/2"	13"
PIL9X102	9"	102"	3"	14-1/2"
PIL9X108	9"	108"	3"	14-1/2"
PIL9X144	9"	144"	3"	14-1/2"
PIL11X108	11"	108"	3-1/2"	14-1/2"
PIL11X120	11"	120"	3-1/2"	14-1/2"
PIL11X144	11"	144"	3-1/2"	14-1/2"

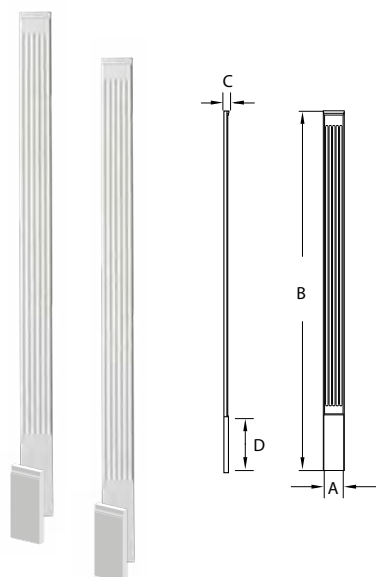

Fluted Narrow Pilaster

TWO-PIECE ADJUSTABLE

Part Number	Width (A)	Height (B)	Projection (C)	Plinth Block Height (D)
PIL5X120E	5-1/4"	120"	1-1/4"	14-1/4"



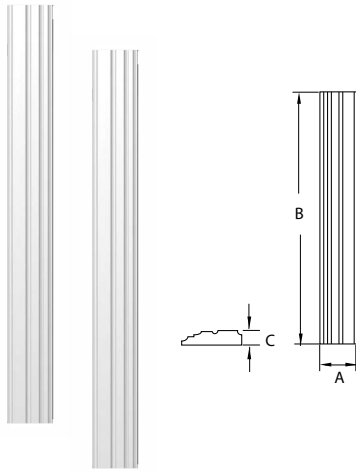

Arch Profile Pilaster

MATCHES 10M DECORATIVE ARCHES

Part Number	Width (A)	Height (B)	Projection (C)
PIL5X120E	10"	192"	2-3/8"

Note: Matching arches can be found on pages 86-87.

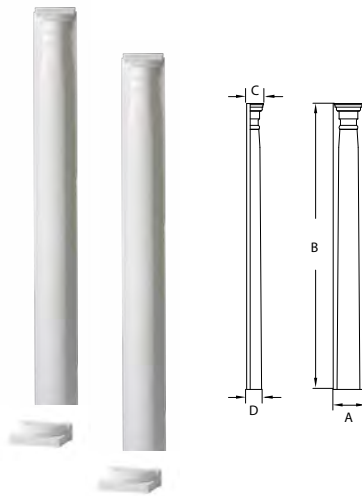

Half-Round Pilaster

ADJUSTABLE COLUMN

Part Number	Width (A)	Shaft Height ¹ (B)	Top Projection (C)	Bottom Projection (D)
PIL5X120E	10"	93-5/8"	4-7/8"	5-1/2"

Fluted Panel Trim

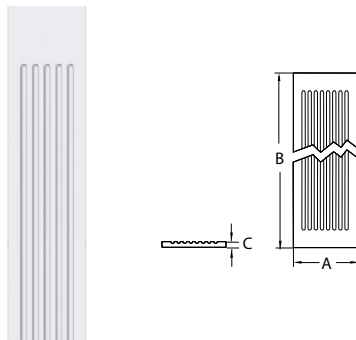

Part Number	Width (A)	Height (B)	Projection (C)
FP12X96	12"	96"	1-1/2"

¹Overall height is adjustable from 80"-96". Shaft sits on top of plinth, which is 3" in height.
Note: Pilasters are sold as a set and may be routed for J-Channel.



Half-Round Arch Trim

4F FLAT

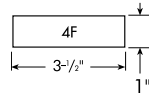
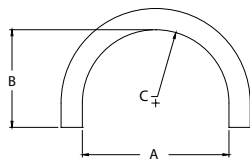
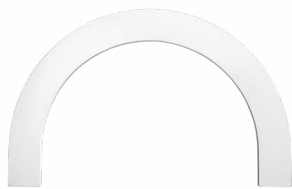

ACCESSORIES



Keystone
K4TF



Keystone
KP4TF



Flat Trim
FLT152



Plinth Block
PB4X4

Part Number	Inside Width (A)	Inside Height (B)	Radius (C)
AR24X4F	24-1/8"	16-1/8"	12-1/8"
AR36X4F	36"	22"	18"
AR37X4F	37-5/8"	22-3/4"	18-3/4"
AR48X4F	48"	28"	24"
AR72X4F	72"	40"	36"

Note: This part uses keystones K4TF and KP4TF only.

Half-Round Arch Trim

4M DECORATIVE

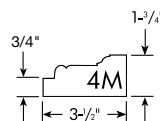
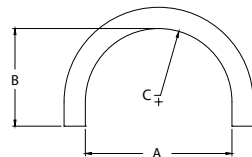

ACCESSORIES



Keystone
K4TM



Keystone
KP4TM

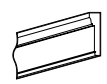

Moulding
MLD215

Part Number	Inside Width (A)	Inside Height (B)	Radius (C)
AR36X4M	36"	22"	18"
AR48X4M	48"	28"	24"

Note: This part uses keystones K4TM and KP4TM only.

Half-Round Arch Trim

6F FLAT

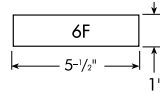
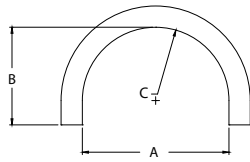
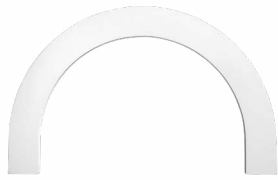

ACCESSORIES



Keystone
K6TF



Keystone
KP6TF



Flat Trim
FLT159



Plinth Block
PB6X6

Part Number	Inside Width (A)	Inside Height (B)	Radius (C)
AR36X6F	36"	22"	18"
AR48X6F	48"	28"	24"

Note: This part uses keystones K6TF and KP6TF only.

Half-Round Arch Trim

6M DECORATIVE

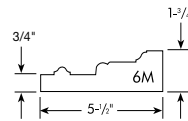
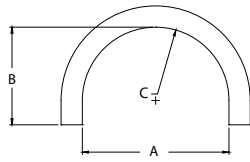

ACCESSORIES



Keystone
K6TM



Keystone
KP6M

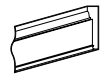

Moulding
MLD220

Part Number	Inside Width (A)	Inside Height (B)	Radius (C)
AR36X6M	36"	21"	18-1/32"
AR40X6M	40"	24"	20"
AR48X6M	48"	28"	24"
AR60X6M	60"	34"	30"
AR72X6M	72"	40"	36"

Note: This part uses keystones K6TM and KP6TM only.

Half-Round Arch Trim

10M DECORATIVE

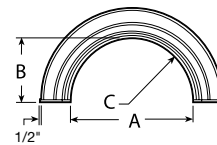
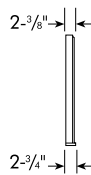

ACCESSORIES



Keystone
K10TM



Pilaster
PIL10X96A | PIL10X192A

Part Number	Inside Width (A)	Inside Height (B)	Radius (C)
AR36X10MC	36"	18-3/4"	18"
AR64X10MC ¹	64"	32-3/4"	32"

Half-Round Arch with Flankers

10M DECORATIVE

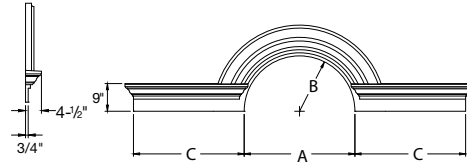

Part Number	Inside Width (A)	Inside Height / Radius (B)	Flanker Width (C)	Overall Width (D)	Accessories
AR36X10MFL108	36"	18"	36"	108"	K10TM SWDH36X18

Circle Trim

4F FLAT

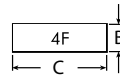
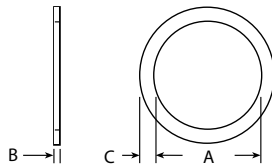
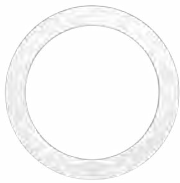

Part Number	Inside Width (A)	Projection (B)	Trim Width (C)
AR36X10MFL108	36"	1"	3-1/2"
CIR36X4F	36-1/8"	1"	3-1/2"

Oval Trim

4F FLAT

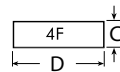
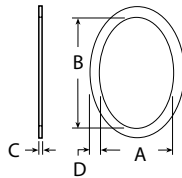

Part Number	Inside Width (A)	Inside Height (B)	Projection (C)	Trim Width (D)
OV24X36X4F	24-1/8"	36-1/8"	1"	3-1/2"

Oval Trim

4M DECORATIVE

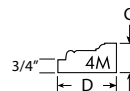
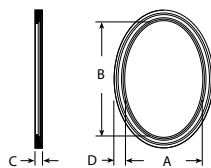

Part Number	Inside Width (A)	Inside Height (B)	Projection (C)	Trim Width (D)
OV24X36X4M	24-1/8"	36-1/8"	1-3/4"	3-1/2"



Window Panel

RAISED PANEL

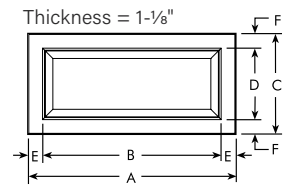

Part Number	Overall Width (A)	Panel Width (B)	Overall Height (C)	Panel Height (D)	Border Width (E)	Border Height (F)
WDP36X18	36"	28"	18"	10"	4"	4"

Dormer Trim System

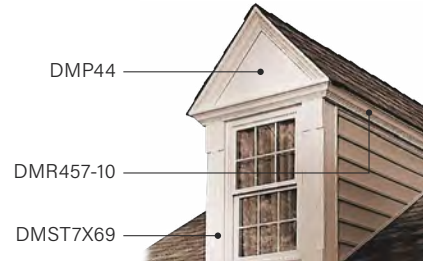









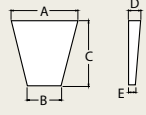

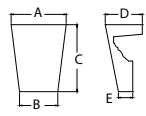
Dormer Trim System

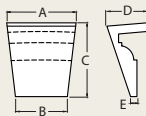
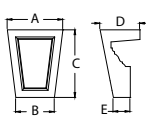
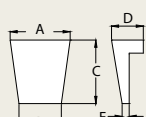
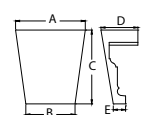
	Part Number	Width (A)	Overall Width (B)	Overall Height (C)	Projection (D)	Pitch (E)	
	DMP44 Pediment	43-3/4"	49-1/4"	33-1/4"	4-1/2"	14 / 12	
	MLD221-16	6-3/4"	—	68-5/8"	1-1/2"	—	
	MLD227-16	—	—	—	—	—	

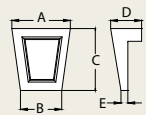
Keystones

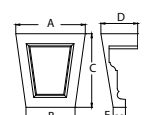
FOR TRIM PROFILES

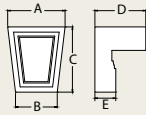
	Part Number	Top Width (A)	Bottom Width (B)	Height (C)	Top Projection (D)	Bottom Projection (E)	Arches & Trim	
	K6 ¹	4-3/4"	2-3/4"	6-1/2"	2-1/4"	1-5/8"	—	
	K8 ¹	9-3/4"	5-3/4"	7-3/4"	2-1/4"	1-1/4"	—	
	K6M	5-3/4"	4"	7"	3-7/8"	1-1/2"	6" WCH, 6" WCH w/ BT	
	K9M	8"	6"	11"	6-1/8"	1-1/8"	6" CH, 6" CH w/ BT 9" WCH, 9" WCH w/ BT	
	K12M	8-1/2"	6"	13"	5-3/4"	2-1/8"	9" CH, 9" CH w/ BT 12" WCH	
	K10SEG	8"	6"	8-1/2"	4-5/8"	3/4"	10" WCHSEG	
	KP6M	5-3/4"	4"	7"	4-1/8"	1-3/4"	6" WCH, 6" WCH w/ BT	
	KP9M	8"	6"	11"	6-1/4"	1-5/8"	6" CH, 6" CH w/ BT 9" WCH, 9" WCH w/ BT 9" CH, 9" CH w/ BT	
	K4TF	4-1/4"	3"	4-1/2"	2-1/4"	1/2"	4F Arches FLT152	
	K6TF	6"	4"	7"	2-3/8"	5/8"	6F Arches FLT159	
	K8TF	7"	5"	8-7/8"	2-1/2"	3/4"	FLT162	
	K4TM	4-1/4"	3"	4-1/2"	2-1/4"	3/4"	4M Arches MLD215	
	K6TM	6"	4"	7"	2-3/8"	7/8"	6M Arches MLD220 DWH221	
	K10TM	8"	5-1/2"	11-1/2"	4"	1-3/4"	10M Arch Trim PIL10X96A PIL10X192A	
	KP4TF	4-1/4"	3"	4-1/2"	2-1/4"	1/2"	4F Arches FLT152	
	KP6TF	6"	4"	7"	2-3/8"	5/8"	6F Arches FLT159	
	KP4TM	4-1/4"	3"	4-1/2"	2-3/4"	3/4"	4M Arch Trim MLD215	
	KP6TM	6"	4"	7"	2-1/2"	7/8"	6M Arch Trim MLD220 DWH221	
	KWM180M	2-3/4"	2"	3-1/8"	2-1/2"	—	Brick Mould Louvers / Trim MLDWM180	

¹Keystones K6 and K8 are not molded on back side.



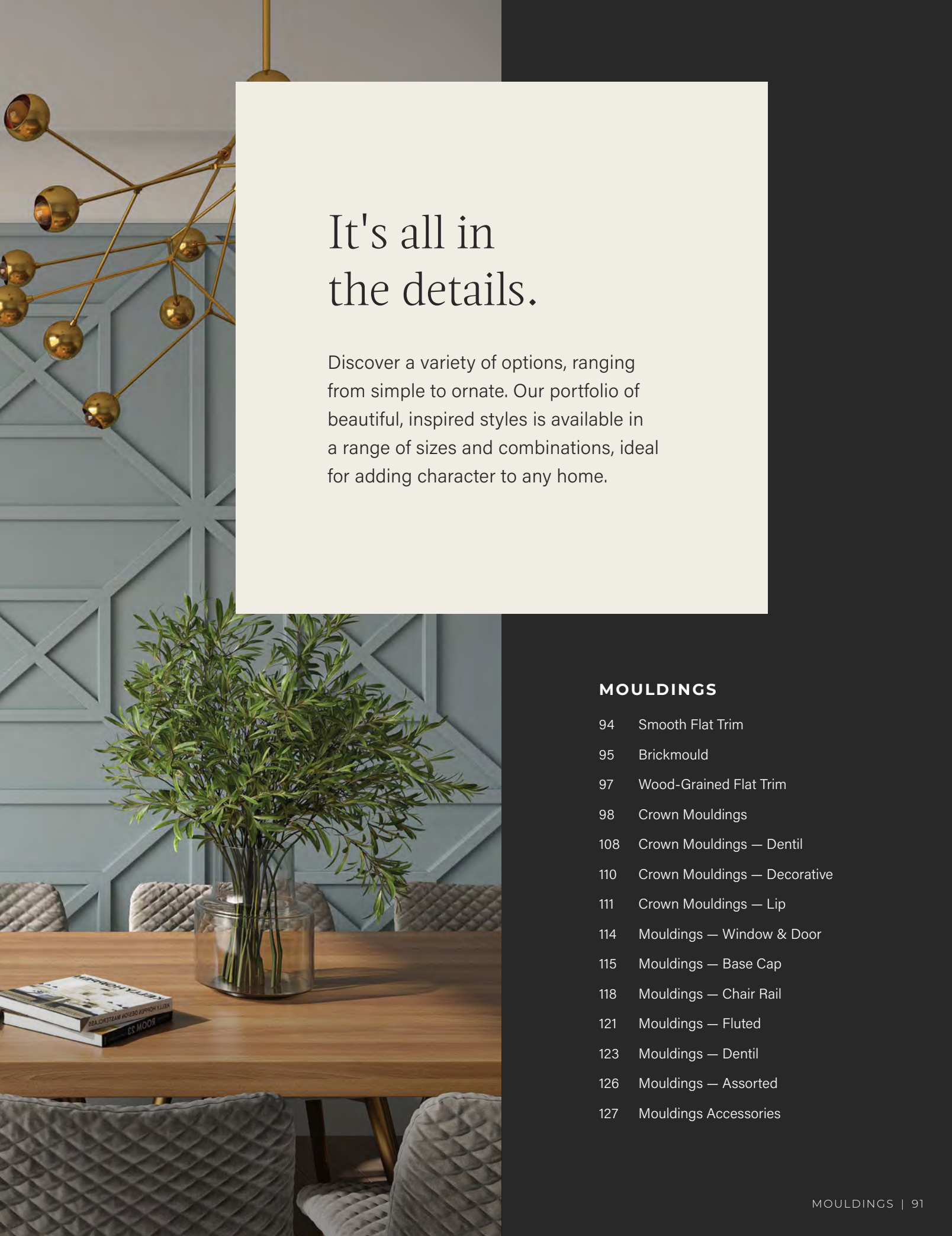

It's all in the details.

Discover a variety of options, ranging from simple to ornate. Our portfolio of beautiful, inspired styles is available in a range of sizes and combinations, ideal for adding character to any home.

MOULDINGS

- 94 Smooth Flat Trim
- 95 Brickmould
- 97 Wood-Grained Flat Trim
- 98 Crown Mouldings
- 108 Crown Mouldings — Dentil
- 110 Crown Mouldings — Decorative
- 111 Crown Mouldings — Lip
- 114 Mouldings — Window & Door
- 115 Mouldings — Base Cap
- 118 Mouldings — Chair Rail
- 121 Mouldings — Fluted
- 123 Mouldings — Dentil
- 126 Mouldings — Assorted
- 127 Mouldings Accessories

Mouldings

HOW TO USE THIS SECTION

The products in this section of the catalog are organized by moulding type. You can find a variety of products to match the aesthetics of almost any application conveniently grouped together. Where applicable, groups of mouldings are further sorted by height, from smallest to largest.

HOW TO ORDER MOULDING ACCESSORIES

Accessories are available to help make moulding installations quick and easy. Rosettes can be used between moulding lengths to eliminate the need for patching to create smooth seams. All rosettes are unattached and must be ordered separately.

MOULDING APPLICATIONS

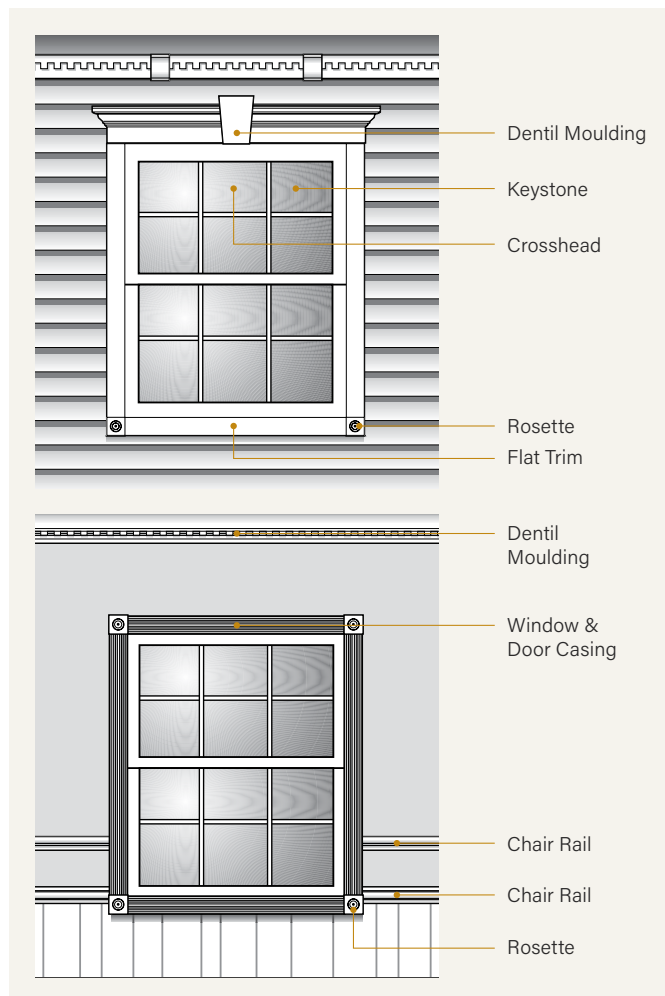



Smooth Flat Trim

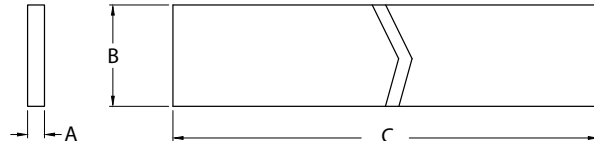

Part Number	Thickness (A)	Width (B)	Length (C)	Accessories	Qty Per Box
FLT131-16	1/2"	3"	16'	—	4
FLT100-12	5/8"	4-3/4"	12'	—	4
FLT1X3-12	3/4"	2-1/2"	12'	—	4
FLT101-12	3/4"	1-1/2"	12'	—	4
FLT102-10	3/4"	2-1/8"	10'	—	4
FLT103-12	3/4"	3"	12'	PB3X3, PB4X4	4
FLT122-16	3/4"	3-1/2"	16'	—	4
FLT110-16	3/4"	5-1/2"	16'	—	4
FLT109-12	3/4"	6"	12'	—	4
FLT186-16	3/4"	7-1/4"	16'	—	4
FLT113-8	3/4"	8"	8'	—	4
FLT118-8	3/4"	10"	8'	—	4
FLT152-8	1"	3-1/2"	8'	4F Arches	4
FLT152-12	1"	3-1/2"	12'	4F Arches	4
FLT152-16	1"	3-1/2"	16'	4F Arches	4
FLT153-12	1"	4"	12'	—	4
FLT159-8	1"	5-1/2"	8'	6F Arches, PB6X6	4
FLT159-12	1"	5-1/2"	12'	6F Arches, PB6X6	4
FLT159-16	1"	5-1/2"	16'	6F Arches, PB6X6	4
FLT162-8	1"	7-1/2"	8'	PB7X7, K8TF	4
FLT170-12	1"	9-1/2"	12'	—	4
FLT170-16	1"	9-1/2"	16'	—	4
FLT172-16	1"	11-1/2"	16'	—	4
FLT175-12	1"	12"	12'	—	4
FLT179-12	1"	16"	12'	—	4



Smooth Flat Trim

Part Number	Thickness (A)	Width (B)	Length (C)	Accessories	Qty Per Box
FLT180-12	1"	24"	12'	—	1
FLT119-17	1"	32-1/4"	16' 11"	—	1
FLT40X96	1"	40"	8'	—	2
FLT194-10	1-1/2"	3-1/2"	10'	—	4
FLT183-12	1-1/2"	5-1/2"	12'	—	4
FLT163-16	1-1/2"	7-1/2"	16'	—	4
FLT182-12	1-1/2"	12-1/4"	12'	—	4
FLT190-12	2"	4"	12'	—	4

Brickmould

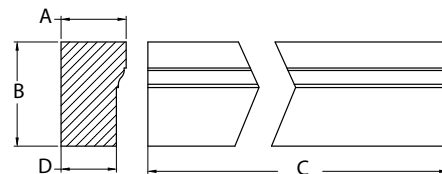

Part Number	Projection (A)	Height (B)	Length (C)	Bottom Thickness (D)	Accessories
MLDWM180-8	1-1/4"	2"	8'	1-1/16"	 Keystone KWM180M
MLDWM182-12	1-1/4"	3"	12'	1-1/16"	



Wood-Grained Flat Trim

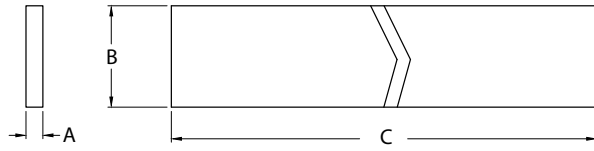









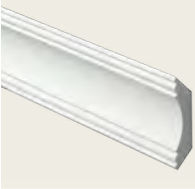
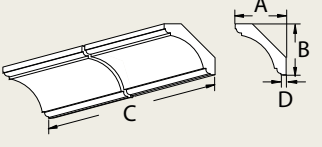

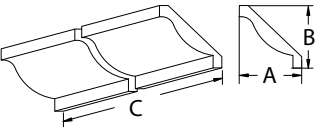
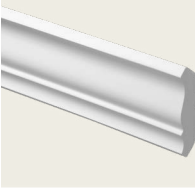
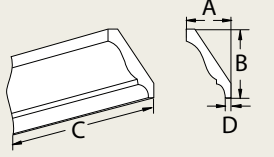

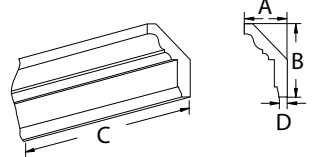
Part Number	Thickness (A)	Width (B)	Length (C)	Qty Per Box
FLT1X4-12RS	3/4"	3-1/2"	12'	4
FLT151-12S	3/4"	3-1/2"	12'	4
FLT110-12S	3/4"	5-1/2"	12'	4
FLT187-12S	3/4"	7-1/2"	12'	4
FLT173-12S	3/4"	11-1/2"	12'	4
FLT30X228X1S	1"	30"	19'	1
FLT150-12S	1-1/2"	3-1/2"	12'	4
FLT111-12S	1-1/2"	5-1/2"	12'	4
FLT197-12S	1-1/2"	7-1/2"	12'	4
FLT9X4X216S	3-1/2"	8-1/2"	18'	2

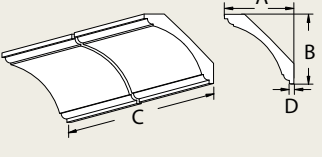

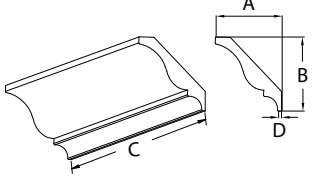

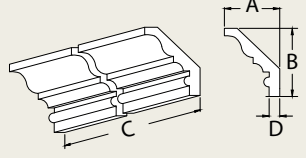

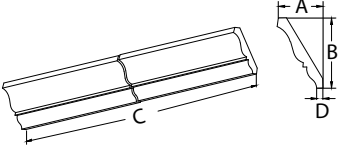
Note: In order by thickness.

Crown Mouldings



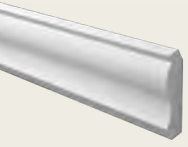
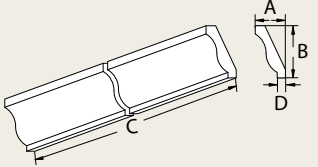

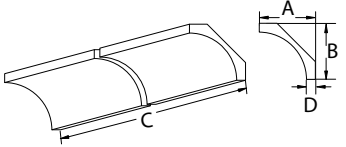
	Part Number	Projection (A)	Height (B)	Length (C)	Bottom Thickness (D)	
	MLD593-16	2-1/2"	2-1/2"	16'	1/4"	
	MLD451-16	3-1/8"	3"	16'	1/2"	
	MLD452-12	2"	3"	12'	1/4"	
	MLD552-12	2-1/8"	3-1/2"	12'	3/8"	
	MLD592-16	3-3/4"	3-7/8"	16'	1/4"	
	MLD454-12	3-5/8"	4-1/8"	12'	1/4"	
	MLD572-16	3-1/4"	4-1/4"	16'	5/8"	
	MLD456-16	2-3/4"	4-3/8"	16'	1/4"	

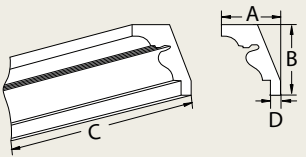

Crown Mouldings

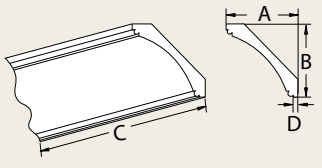
	Part Number	Projection (A)	Height (B)	Length (C)	Bottom Thickness (D)	
	MLD467-16	2-3/4"	4-3/4"	16'	3/4"	
	MLD584-16	4-3/4"	4-3/4"	16'	3/4"	
	MLD460-12	4-3/8"	5-1/8"	12'	3/4"	

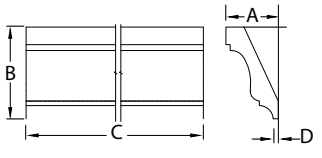
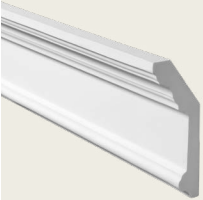
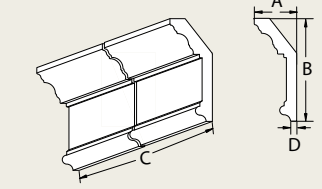
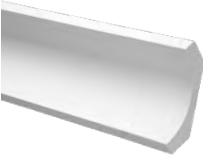
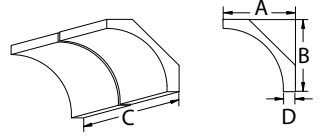

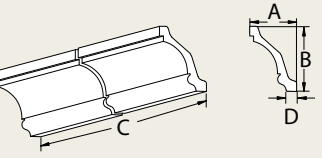
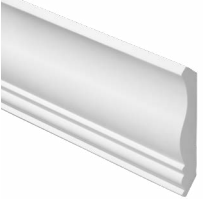
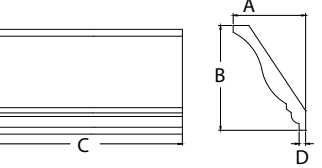
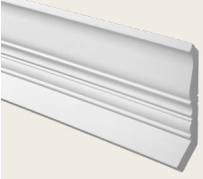
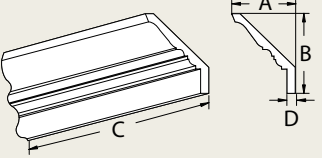



Crown Mouldings

	Part Number	Projection (A)	Height (B)	Length (C)	Bottom Thickness (D)		
	MLD606-12	5-1/4"	5-1/4"	12'	1/4"		
	MLD1037-12	3-1/8"	5-5/8"	12'	1/4"		
	MLD587-16	2-3/8"	5-3/4"	16'	3/8"		
	MLD590-16	6"	6-1/4"	16'	1"		
	MLD589-16	4-3/8"	6-1/2"	16'	1-1/8"		
	MLD453-16	4-3/4"	6-3/4"	16'	1/2"		
	MLD570-12	5-1/2"	6-7/8"	12'	3/4"		

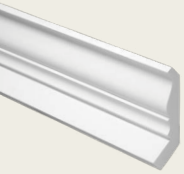
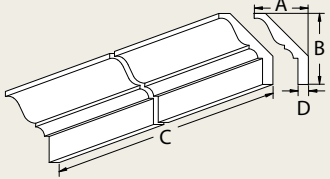

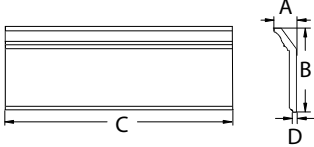
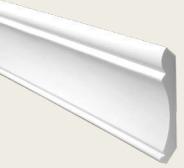
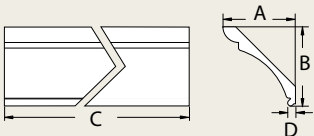
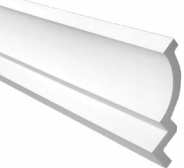
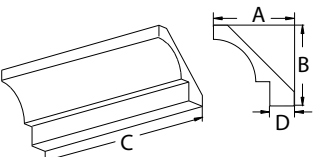



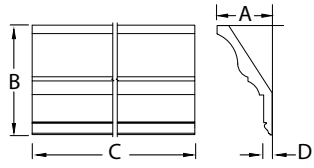
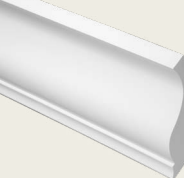
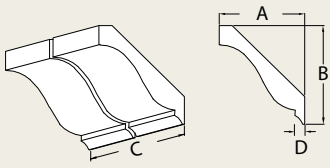





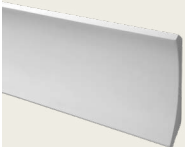
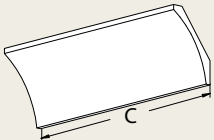
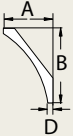

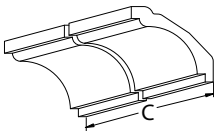
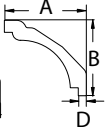
Crown Mouldings

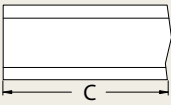
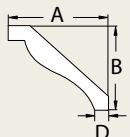
	Part Number	Projection (A)	Height (B)	Length (C)	Bottom Thickness (D)	
	MLD569-12	5-3/4"	7-1/2"	12'	1-1/8"	
	MLD253-16	2-3/8"	7-5/8"	16'	3/8"	
	MLD457-12	6-7/8"	7-5/8"	12'	3/4"	
	MLD582-12	7-7/8"	7-7/8"	12'	2-3/8"	
	MLD583-16	8"	8"	16'	1/2"	
	MLD1001-12	4-1/8"	8-1/8"	12'	1/8"	
	MLD1002-12	5-1/8"	10-1/8"	12'	1/8"	
	MLD449-16	7-1/8"	8-1/2"	16'	1/8"	

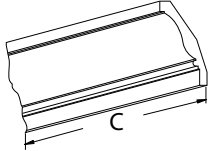
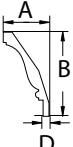

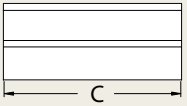
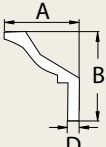

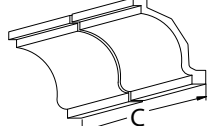
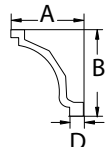

Crown Mouldings

	Part Number	Projection (A)	Height (B)	Length (C)	Bottom Thickness (D)		
	MLD635-12	6"	9"	12'	5/8"		
	MLD591-16	10-1/4"	9-1/2"	16'	1"		
	MLD450-16	11-1/2"	9-5/8"	16'	1-1/2"		
	MLD555-12	5-1/4"	10-3/4"	12'	7/8"		
	MLD371-16	6-1/2"	11"	16'	1"		
	MLD588-16	9-1/4"	11"	16'	1-3/4"		

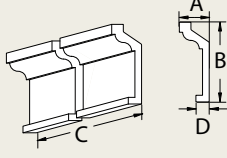

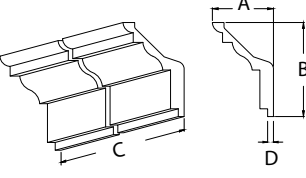
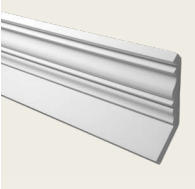
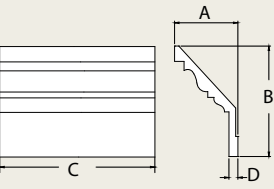

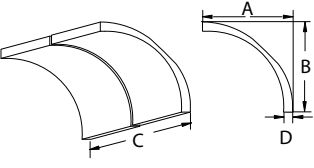
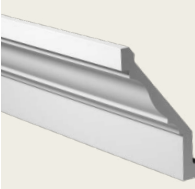
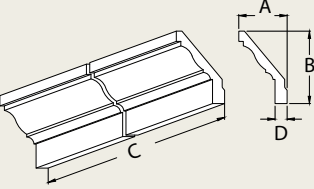
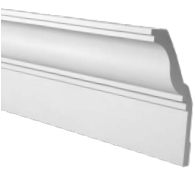
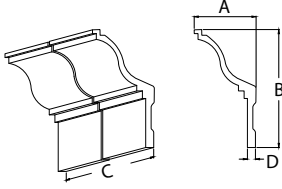
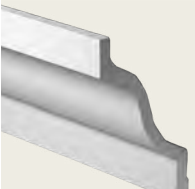
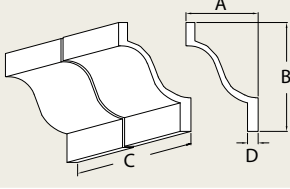
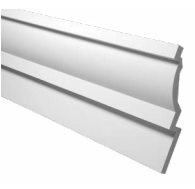
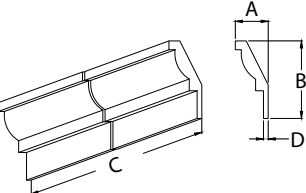
Crown Mouldings

	Part Number	Projection (A)	Height (B)	Length (C)	Bottom Thickness (D)	
	MLD539-16	4-1/2"	12"	16'	2"	
	MLD524-16	8"	12-1/8"	16'	1"	
	MLD580-12	7-1/8"	12-3/8"	12'	1"	
	MLD734-12	14-3/8"	14-3/8"	12'	1-1/4"	
	MLD556-16	10"	15"	16'	2-1/2"	
	MLD536-12	8-1/8"	15-1/2"	12'	1"	
	MLD528-12	9-1/2"	15-3/4"	12'	1-1/2"	
	MLD586-16	7"	16-1/2"	16'	1"	



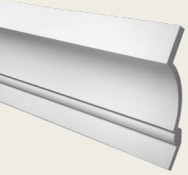
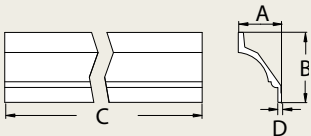

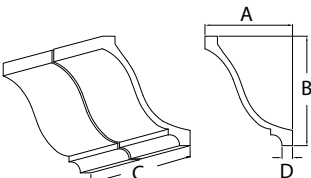

Crown Mouldings

	Part Number	Projection (A)	Height (B)	Length (C)	Bottom Thickness (D)	
	MLD585-12	10-1/2"	17"	12'	7/8"	
	MLD481-12	14"	17-1/2"	12'	1-3/4"	

Crown Mouldings

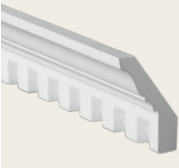
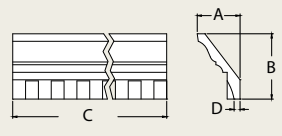
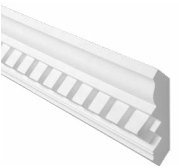
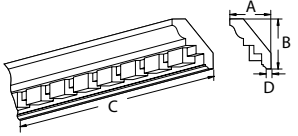
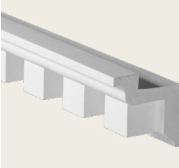
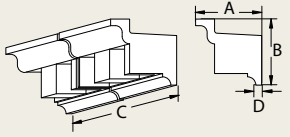
DENTIL

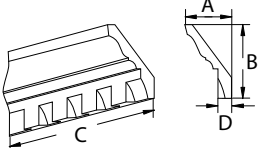
Mouldings

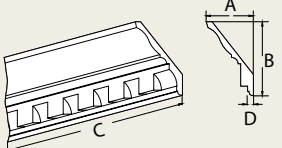
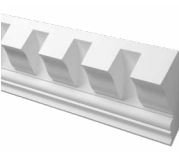
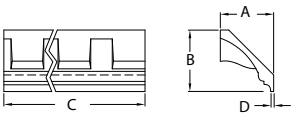
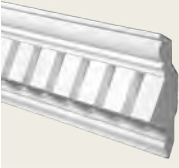
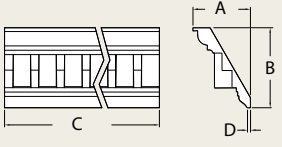
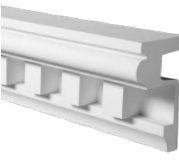
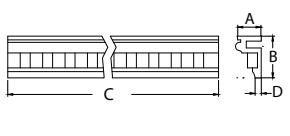
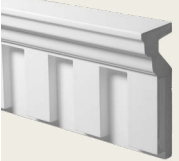
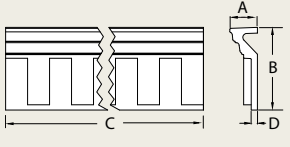
	Part Number	Projection (A)	Height (B)	Length (C)	Bottom Thickness (D)	Design Repeat	Tooth & Space	
	MLD404-16	2-1/2"	3-7/8"	16'	1/4"	1-1/2"	3/4" Tooth 3/4" Space	
	MLD406-16	3-3/8"	4"	16'	3/8"	2"	1-1/4" Tooth 3/4" Space	
	MLD365-16	5"	5"	16'	3/8"	4-5/8"	2-1/4" Tooth 2-3/8" Space	
	MLD410-12	3-1/4"	6-7/8"	12'	1/2"	3"	1-1/2" Tooth 1-1/2" Space	
	MLD411-16	4-1/2"	7"	16'	1/2"	3"	1-1/2" Tooth 1-1/2" Space	
	MLD440-12	6-1/2"	7-1/4"	12'	3/8"	6-5/8"	4" Tooth 2-5/8" Space	
	MLD430-12	5-3/4"	8"	12' 2-1/4"	1/4"	2-5/8"	1-3/4" Tooth 7/8" Space	
	MLD362-16	5-1/8"	8-3/8"	16'	1-1/4"	4-1/2"	2" Tooth 2-1/2" Space	
	MLD336-16	3-1/8"	9-3/8"	16' 1"	3/4"	5"	2-1/2" Tooth 2-1/2" Space	



Crown Mouldings

DENTIL

	Part Number	Projection (A)	Height (B)	Length (C)	Bottom Thickness (D)	Design Repeat	Tooth & Space	
	MLD435-16	9"	10"	16'	3/4"	7-3/8"	3-7/8" Tooth 3-1/2" Space	
	MLD412-16	5-3/8"	10-5/8"	16'	1/2"	4"	3" Tooth 1" Space	
	MLD413-12	8-1/2"	11-1/8"	12'	1-1/2"	5-5/8"	3" Tooth 2-5/8" Space	
	MLD419-12	6-3/4"	14-1/2"	12'	1-3/8"	3"	1-1/2" Tooth 1-1/2" Space	
	MLD421-12	10"	14-1/2"	12'	3/4"	6"	2" Tooth 4" Space	
	MLD461-8	9-7/8"	19"	8'	1"	2-1/2"	1-1/2" Tooth 1" Space	









Crown Mouldings

DECORATIVE

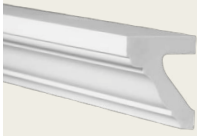
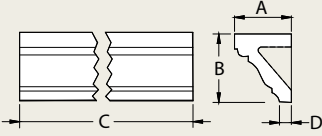
	Part Number	Projection (A)	Height (B)	Length (C)	Bottom Thickness (D)	Design Repeat	
	MLD600-10 Florentine	3/4"	4-1/4"	10'	1/4"	5-5/8"	
	MLD640-8 Scalloped	1"	5-3/4"	8'	1"	6"	
	MLD425-12	4-1/8"	9-1/2"	11' 5"	3/4"	13-1/2"	

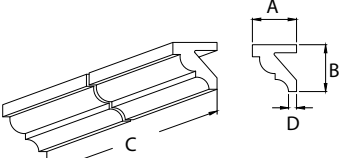
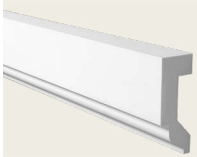
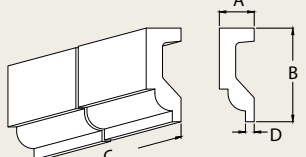
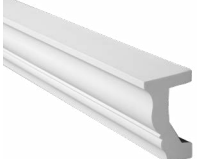
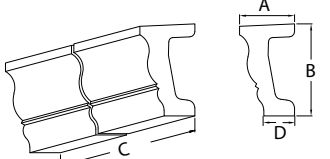
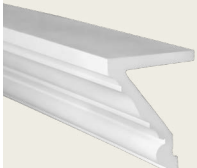
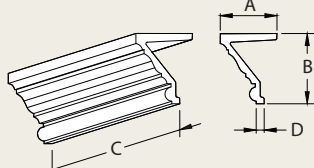

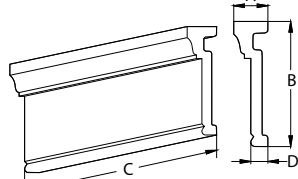

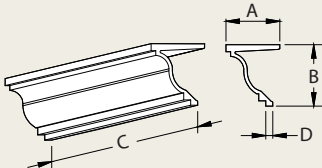
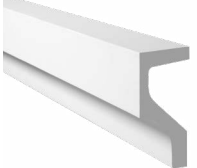
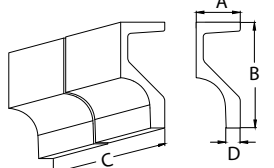

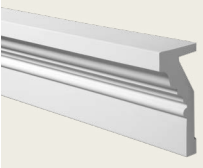
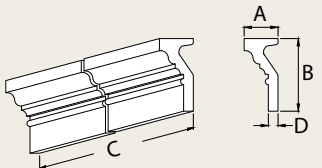

Crown Mouldings

LIP

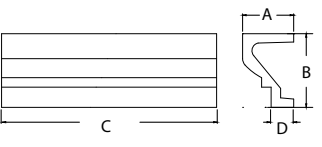
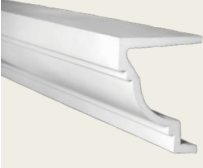
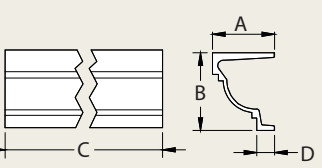
	Part Number	Projection (A)	Height (B)	Length (C)	Bottom Thickness (D)	
	MLD240-8	3-1/4"	4"	8'	3/4"	
	MLD513-16	4-1/8"	4-3/8"	16'	3/4"	
	MLD523-16	2"	5-1/4"	16'	1/2"	
	MLD509-16	3-1/4"	5-3/8"	16'	1-3/4"	
	MLD510-12	4-3/8"	5-1/2"	12'	5/8"	
	MLD226-10	1-1/2"	5-1/2"	10'	3/4"	
	MLD226-12	1-1/2"	5-1/2"	12'	3/4"	
	MLD226-16	1-1/2"	5-1/2"	16'	3/4"	
	MLD511-12	5-3/4"	6-1/2"	12'	3/4"	
	MLD548-16	3-1/8"	7-1/2"	16'	1-1/8"	

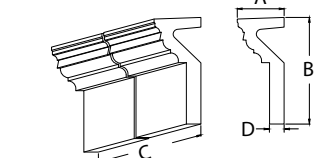
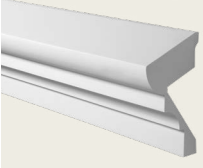
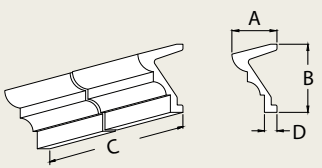
Crown Mouldings

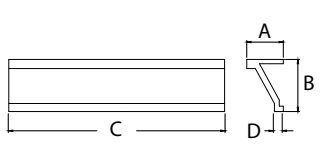
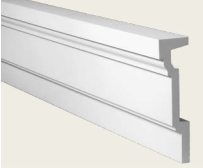
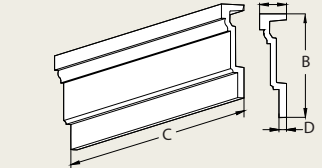

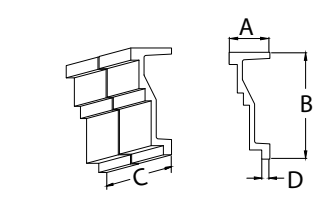

LIP

	Part Number	Projection (A)	Height (B)	Length (C)	Bottom Thickness (D)		
	MLD527-16	3-1/2"	7-5/8"	16'	1"		
	MLD311-16	5-3/8"	7-3/4"	16'	2-3/8"		
	MLD520-16	6-1/8"	8-1/8"	16'	1-7/8"		
	MLD508-12	3-5/8"	8-3/8"	12'	1-1/8"		
	MLD547-16	5-3/8"	8-5/8"	16'	1-1/2"		
	MLD512-16	8-1/2"	12-1/8"	16'	2-1/8"		
	MLD505-8 Massive Fascia	3-3/8"	13"	8'	1"		
	MLD521-8	5"	13-1/8"	8'	1"		

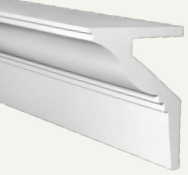
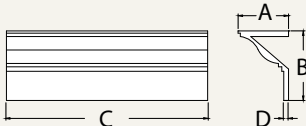

Crown Mouldings

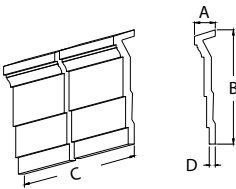
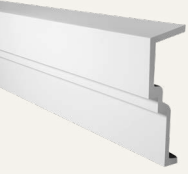
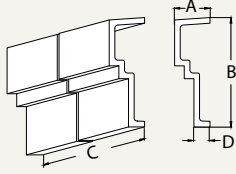
LIP

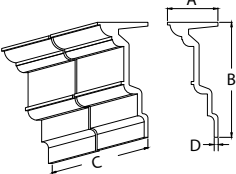
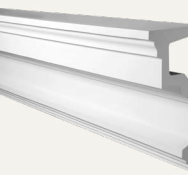
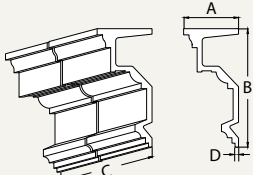
	Part Number	Projection (A)	Height (B)	Length (C)	Bottom Thickness (D)		
	MLD472-12	11-1/4"	15-1/2"	12'	1-1/8"		
	MLD506-16	3"	16-3/8"	16'	7/8"		
	MLD533-12	5-1/2"	17"	12'	2-1/2"		
	MLD543-12	8-1/4"	19"	12'	1/2"		
	MLD534-12	8-7/8"	19-1/8"	12'	1/2"		



Mouldings

WINDOW & DOOR

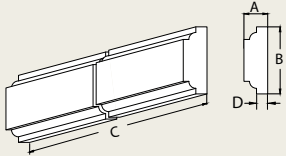
	Part Number	Projection (A)	Height (B)	Length (C)	Bottom Thickness (D)	
	MLD637-16 Flat Astragal	1/2"	1-1/2"	16'	3/4"	
	MLD710-10 Sill	3-1/2"	1-1/2" Tapers to 1"	10'	—	
	MLD231-12 Window & Door Casing	1"	1-3/4"	12'	1/4"	
	MLD214-12 Window & Door Casing	2"	2-7/8"	12'	3/4"	
	MLD234-16 Window & Door Casing	1"	3-1/2"	16'	3/8"	

Mouldings

BASE CAP

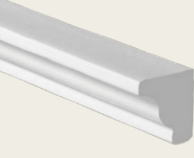
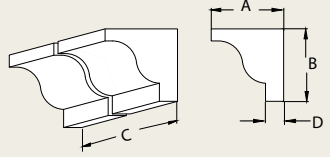
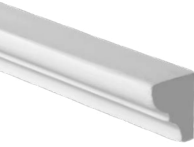
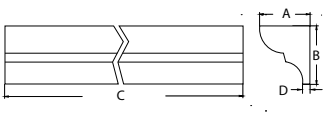
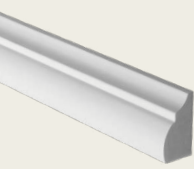
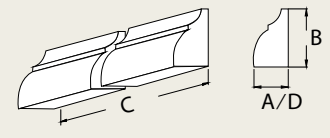
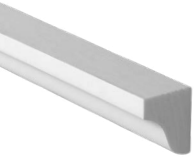
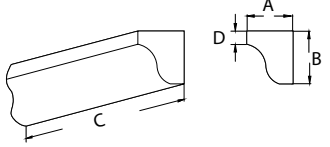
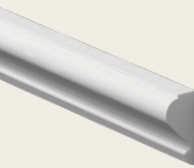
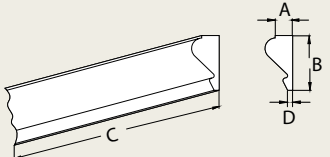
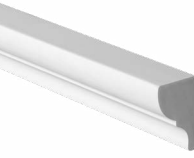
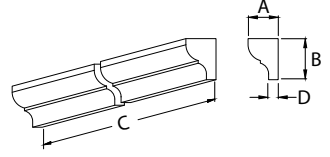
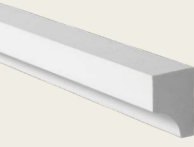
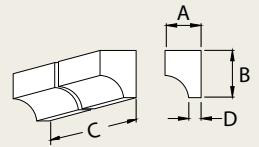
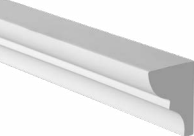
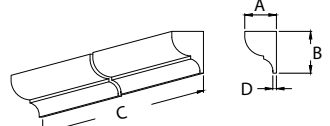
	Part Number	Projection (A)	Height (B)	Length (C)	Bottom Thickness (D)	
	MLD633-8	3/4"	3/4"	8'	1/4"	
	MLD626-8	1-1/8"	1-1/4"	8'	1/8"	
	MLD618-16 Base Cap	1"	1-1/2"	16'	1"	
	MLD601-12	1-1/4"	1-1/2"	12'	3/8"	
	MLD612-12	3/4"	1-3/8"	12'	1/8"	
	MLD634-16	1-3/8"	1-7/8"	16'	1/4"	
	MLD627-16	1-5/8"	2-1/8"	16'	1/2"	
	MLD649-16	1-1/2"	2-1/8"	16'	3/8"	



Mouldings

BASE CAP









	Part Number	Projection (A)	Height (B)	Length (C)	Bottom Thickness (D)		
	MLD611-12	1-1/8"	2-1/4"	12'	3/8"		
	MLD629-10	2-1/4"	2-1/4"	10'	3/8"		
	MLD613-12	2-3/8"	2-3/4"	12'	1"		
	MLD631-16	7/8"	3"	16'	1/2"		
	MLD614-16	1-5/8"	5-1/2"	16'	3/4"		

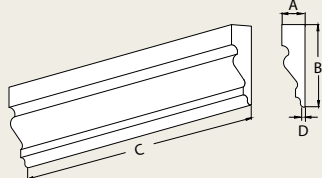

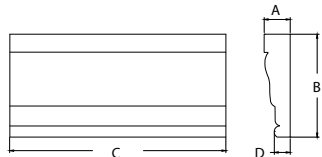
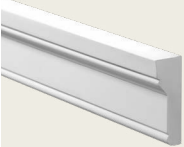
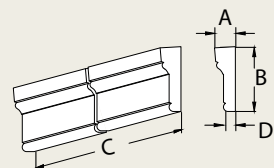
Mouldings

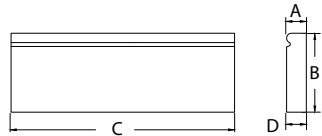
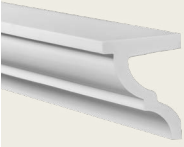
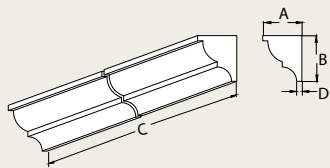
CHAIR RAIL

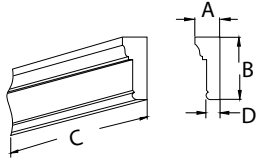
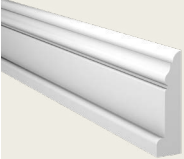
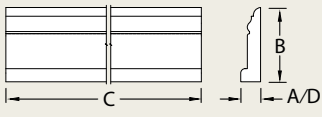

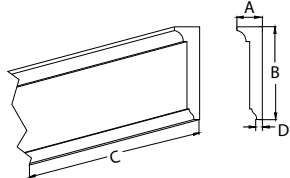
Mouldings

	Part Number	Projection (A)	Height (B)	Length (C)	Bottom Thickness (D)	
	MLD621-16	1/2"	2"	16'	18"	
	MLD230-16	3/4"	3-1/4"	16'	1/2"	
	MLD237-16	1-1/8"	3-1/2"	16'	3/8"	
	MLD715-16 Beaded	1"	4"	16'	—	
	MLD641-16	3-3/4"	4-3/8"	16'	1/2"	
	MLD250-8	1-3/4"	4-1/2"	8'	1"	
	MLD250-12	1-3/4"	4-1/2"	12'	1"	
	MLD1019-12	1-1/8"	5-1/4"	12'	1-1/8"	
	MLD1020-12	1-1/8"	7-1/4"	12'	1-1/8"	
	MLD224-12	1-1/2"	5-1/2"	12'	3/8"	





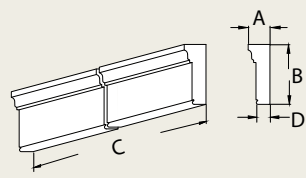

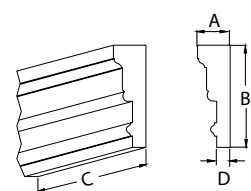





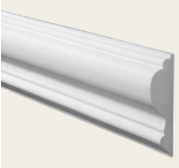
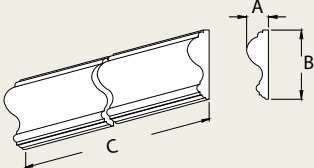

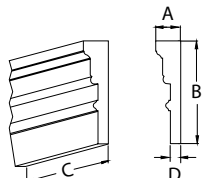
Mouldings

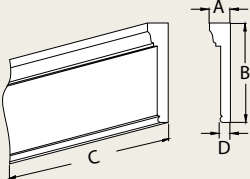
CHAIR RAIL

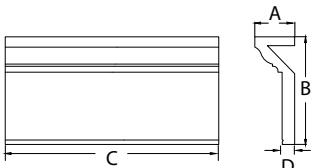
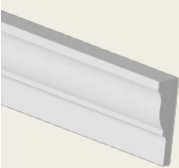
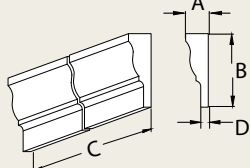
	Part Number	Projection (A)	Height (B)	Length (C)	Bottom Thickness (D)	Accessories	
	MLD236-16	2"	5-1/2"	16'	1-1/4"	—	
	MLD220-12 6M Profile	1-3/4"	5-1/2"	12'	3/4"	K6TM KP6TM	
	MLD220-16 6M Profile	1-3/4"	5-1/2"	16'	3/4"		

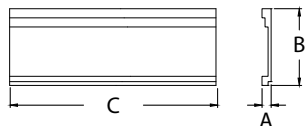
Mouldings

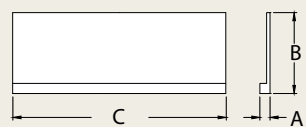
CHAIR RAIL

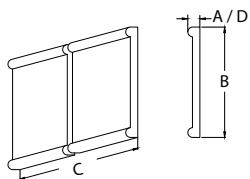
	Part Number	Projection (A)	Height (B)	Length (C)	Bottom Thickness (D)	
	MLD639-16	1-7/8"	6-1/4"	16'	—	
	MLD221-16	1-3/4"	7"	16'	3/4"	
	MLD227-16	1-1/2"	9"	16'	3/4"	
	MLD246-16	3-3/8"	9-1/8"	16'	1"	
	MLD644-16	3"	9-3/4"	16'	1"	
	MLD530-8 Coordinates with MLD531-8	1-1/2"	12-5/8"	8'	—	
	MLD531-8 Coordinates with MLD530-8	1-1/2"	12"	8'	—	
	MLD522-16	1-5/8"	14-3/4"	16'	1-5/8"	



Mouldings



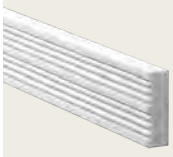
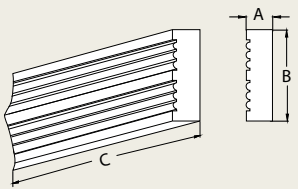
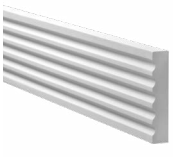
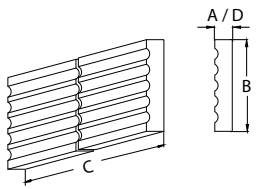
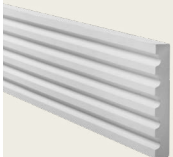
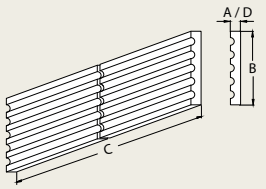



FLUTED

	Part Number	Projection (A)	Height (B)	Length (C)	Bottom Thickness (D)	Accessories	
	MLD205-12	7/8"	3"	12'	—	PB3X3 PB4X4	
	MLD207-16	1"	5-1/4"	16'	1"	PB6X6	
	MLD208-16	1"	7-1/4"	16'	1"	—	

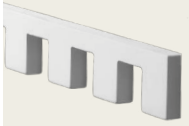
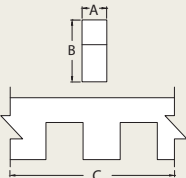
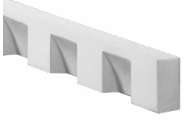
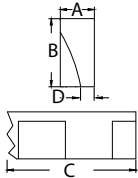
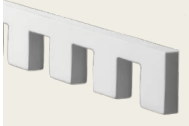
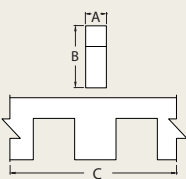
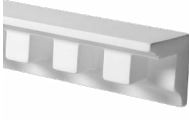
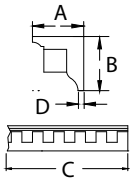
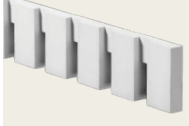
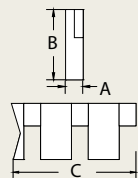

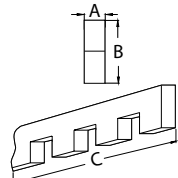

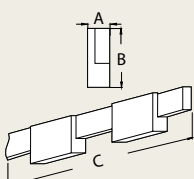

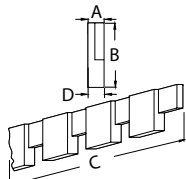

Mouldings

DENTIL

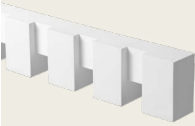
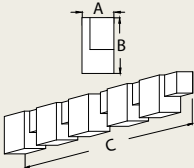
	Part Number	Projection (A)	Height (B)	Length (C)	Bottom Thickness (D)	Design Repeat	Tooth & Space	
	MLD357-8 CHTX6 Dentil Trim	1/2"	1-1/4"	8'	—	1-1/2"	3/4" Tooth 3/4" Space	
	MLD304-8 WCHX9 Dentil Trim	5/8"	1-1/4"	8'	1/4"	2-1/2"	1-1/4" Tooth 1-1/4" Space	
	MLD358-8 CHTX9 Dentil Trim	1/2"	1-1/2"	8'	—	2"	1" Tooth 1" Space	
	MLD313-8	2-1/4"	2-3/8"	8'	1/4"	2"	1" Tooth 1" Space	
	MLD355-8	5/8"	2-1/2"	8' 3/8"	—	2-1/8"	1-3/8" Tooth 3/4" Space	
	MLD354-12	1"	3-1/8"	12' 2-1/4"	—	3-1/4"	1-5/8" Tooth 1-5/8" Space	
	MLD351-8	1-1/4"	3-1/4"	8' 2"	—	7"	3-1/2" Tooth 3-1/2" Space	
	MLD350-8	7/8"	3-1/2"	8' 3-3/4"	1/2"	3-3/4"	2-3/16" Tooth 1-1/2" Space	

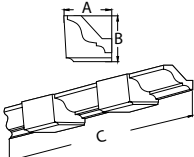
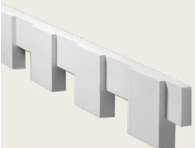
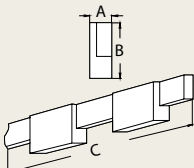
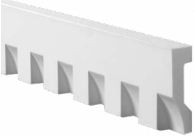
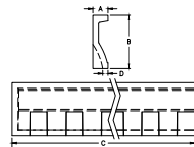
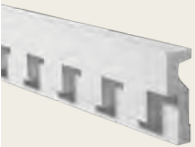
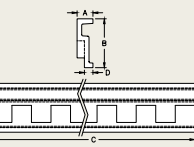
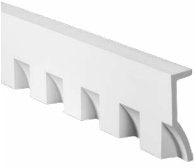
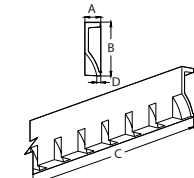
Mouldings

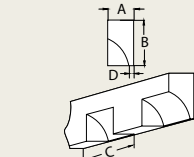

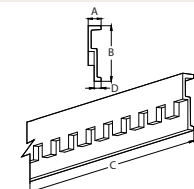
DENTIL

	Part Number	Projection (A)	Height (B)	Length (C)	Bottom Thickness (D)	Design Repeat	Tooth & Space	
	MLD352-8	2"	3-1/2"	8' 3-3/4"	—	3-3/4"	2-1/4" Tooth 1-1/2" Space	
	MLD360-8	3-1/2"	3-3/4"	8'	—	8"	3-3/4" Tooth 4-3/8" Space	
	MLD353-8	1-1/4"	4-1/2"	8' 1/4"	—	8-3/4"	4-3/8" Tooth 4-3/8" Space	
	MLD310-12	1-1/4"	4-1/2"	12'	1/2"	3"	1-1/2" Tooth	
	MLD310-16	1-1/4"	4-1/2"	16'	1/2"		1-1/2" Space	
	MLD332-8	1-5/8"	5"	8'	7/8"	4"	2" Tooth 2" Space	
	MLD320-8	1-5/8"	5-3/4"	8'	3/8"	4-1/2"	2-3/8" Tooth	
	MLD320-12	1-5/8"	5-3/4"	12'	3/8"		2-1/4" Space	
	MLD320-16	1-5/8"	5-3/4"	16' 1-1/2"	3/8"			
	MLD335-12	3-3/8"	6-1/8"	12'	1/2"	7-3/16"	3-9/16" Tooth 3-10/16" Space	
	MLD330-12	1-5/8"	7"	12'	7/8"	4"	2" Tooth 2" Space	



Mouldings

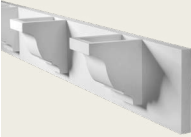
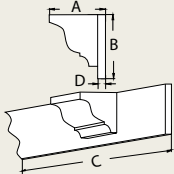
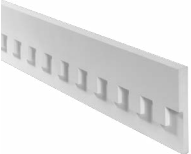
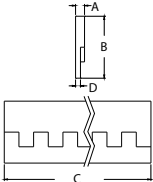
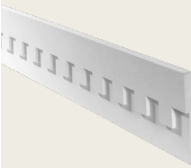
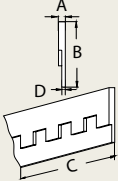

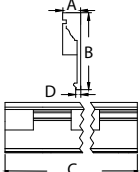



DENTIL

	Part Number	Projection (A)	Height (B)	Length (C)	Bottom Thickness (D)	Design Repeat	Tooth & Space	
	MLD370-8	6-1/2"	7-1/2"	8'	1"	19-1/4"	4-3/4" Tooth 14-1/2" Space	
	MLD331-16	1-3/8"	9-1/2"	16' 1-1/2"	3/4"	4-1/2"	2-1/4" Tooth 2-1/4" Space	
	MLD333-12	1-3/16"	11-1/2"	12' 4-1/2"	5/8"	5-1/2"	2-3/4" Tooth 2-3/4" Space	
	MLD434-16	3-3/4"	16"	15' 9"	1/8"	21"	9" Tooth 12" Space	

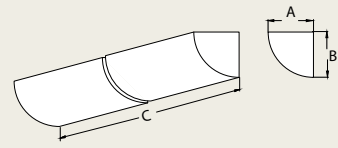
Note: Part comes with routed channel as shown in profile line art.

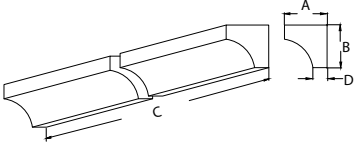
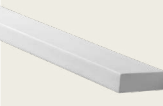
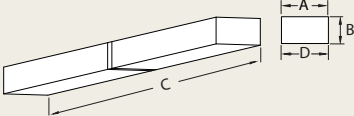
Mouldings

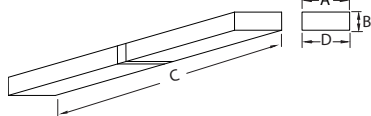
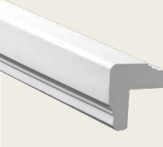
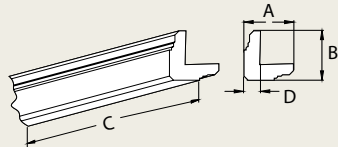
ASSORTED

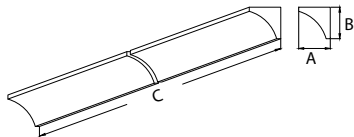
	Part Number	Projection (A)	Height (B)	Length (C)	Bottom Thickness (D)	
	MLD603-8 Quarter Round	1/2"	1/2"	8'	3/4"	
	MLD628-8 Cove	3/4"	3/4"	8'	1/4"	
	MLD716-12 Bottom Trim Accessory for 6" high Distinction crosshead	1-3/4"	1"	12'	1-3/4"	
	MLD758-12 Bottom Trim Accessory for 9" high Distinction crosshead	2-5/8"	1"	12'	2-5/8"	
	MLD607-8 Corner Strip	2-1/4"	2-1/4"	8'	3/4"	
	MLD660-10 Cove	2-3/8"	2-3/8"	10'	—	

Mouldings

ASSORTED

Part Number	Projection (A)	Height (B)	Length (C)	Bottom Thickness (D)	Accessories
 MLD215-12 4M Profile	1-3/4"	3-1/2"	12'	3/4"	K4TM KP4TM

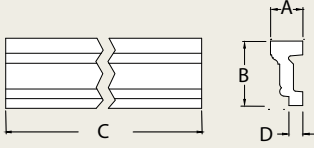

 MLD605-12 Half Round	1-3/4"	3-1/2"	12'	—	—
---	--------	--------	-----	---	---



Moulding Accessories

ROSETTES

Part Number	Width (A)	Projection (B)	Matching Parts
PB2.5X2.5	2-1/2"	3/4"	—
PB3X3	3-5/8"	7/8"	FLT103 MLD205
PB3.5X3.5	3-1/2"	3/4"	—
PB3.875X3.875	3-7/8"	1-1/8"	—
PB4X4	3-5/8"	1-1/8"	FLT103 MLD205 4F Arches
PB5X5	5-1/4"	1"	FLT109
PB6X6	5-5/8"	1-1/8"	FLT159 MLD706 6F Arches

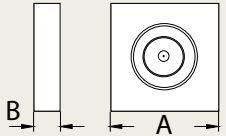

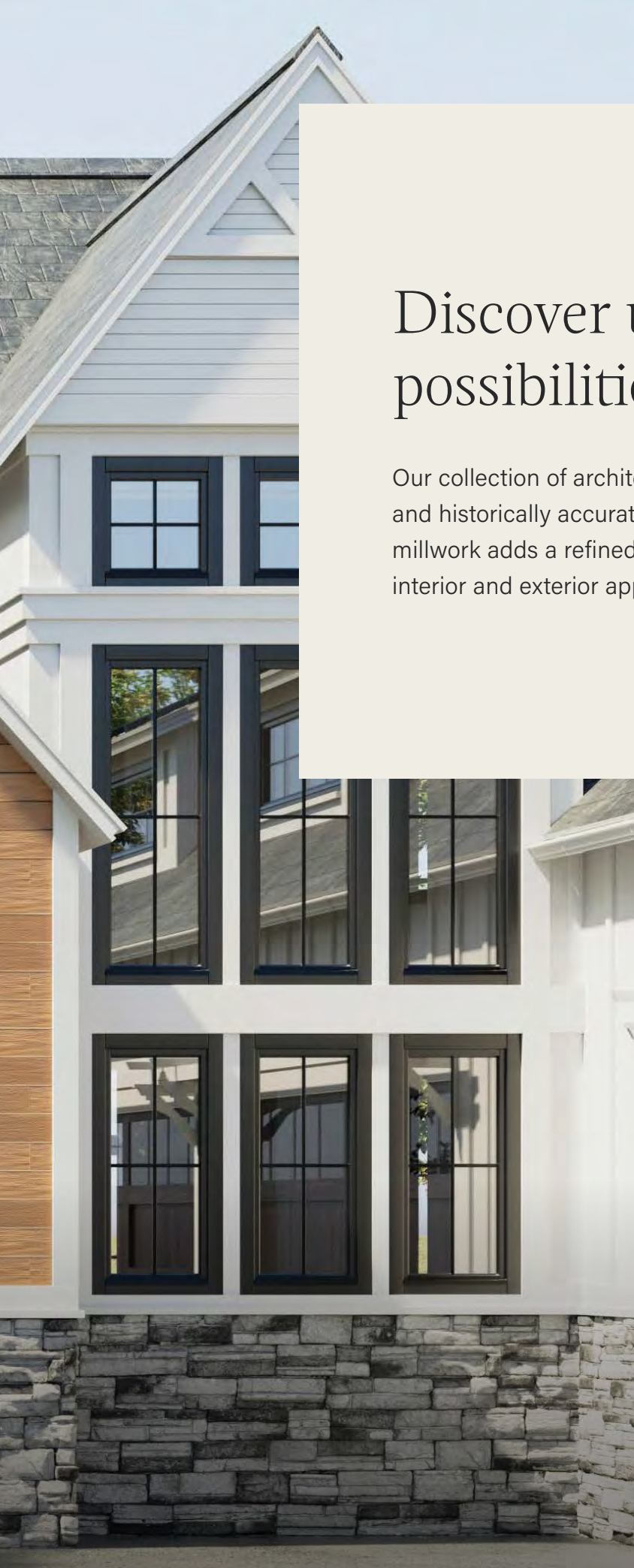

Discover unlimited possibilities.

Our collection of architecturally correct and historically accurate decorative millwork adds a refined look to both interior and exterior applications.

DECORATIVE MILLWORK

- 132 Smooth Mantels
- 138 Wood-Grained Beam Mantels
- 142 Smooth Beams
- 146 Wood-Grained Beams
- 154 Beam Top & End Caps
- 154 Beam Straps
- 155 Beam Plates & Hardware
- 156 Wood-Grained Gable Pediments
- 163 Smooth Gable Pediments
- 166 Smooth Brackets
- 181 Smooth Knee Braces
- 182 Smooth Dentil Blocks
- 190 Wood-Grained Brackets
- 193 Wood-Grained Knee Braces
- 195 Wood-Grained Corbels
- 200 Wood-Grained Rafter Tails
- 202 Trellis Systems
- 206 Tile Vents
- 206 Fixture Mounts
- 207 Fishscale Panel
- 208 Spires
- 209 Finals

Decorative Millwork

HOW TO USE THIS SECTION

The products in this section of the catalog are organized by moulding type. You can find a variety of products to match the aesthetics of almost any application conveniently grouped together. Where applicable, groups of mouldings are further sorted by height, from smallest to largest.

HOW TO ORDER DECORATIVE MILLWORK ACCESSORIES

Some decorative millwork products have accessories available or are an accessory to another product. All decorative millwork accessories are unattached and must be ordered separately.





Smooth Beam Mantel

FEATURES:

- Available in 6" x 8" and 8" x 10" (height x projection) with lengths measuring 60"-90", in 6" increments.
- Hardware kit included.



Nominal Dimensions (Height x Projection x Width)	Actual Dimensions		
	Height	Projection	Width
6X8X__	5-1/2"	7-1/2"	60", 66", 72", 78", 84", 90"
8X10X__	7-1/2"	9-1/2"	60", 66", 72", 78", 84", 90"

6" x 8" Part Number	8" x 10" Part Number
BMSMT6X8X60-EC	BMSMT8X10X60-EC
BMSMT6X8X66-EC	BMSMT8X10X66-EC
BMSMT6X8X72-EC	BMSMT8X10X72-EC
BMSMT6X8X78-EC	BMSMT8X10X78-EC
BMSMT6X8X84-EC	BMSMT8X10X84-EC
BMSMT6X8X90-EC	BMSMT8X10X90-EC





Stepped Mantel

FEATURES:

- Available in 8" x 9" (height x projection) with lengths measuring 60" and 72".
- Hardware kit included.



Nominal Dimensions (Height x Projection x Width)	Actual Dimensions				
	Top Projection	Bottom Projection	Height	Top Width	Bottom Width
8X9X60	8"	5-3/4"	8-1/2"	64-1/2"	60"
8X9X72	8"	5-3/4"	8-1/2"	76-1/2"	72"

8" x 9"

Part Number

MS8X9X60

MS8X9X72





Classic Mantel

FEATURES:

- Available in 8" x 9" (height x projection) with lengths measuring 60" and 72".
- Hardware kit included.



Nominal Dimensions (Height x Projection x Width)	Actual Dimensions				
	Top Projection	Bottom Projection	Height	Top Width	Bottom Width
8X9X60	8"	5-1/4"	8-1/2"	65-1/2"	60"
8X9X72	8"	5-1/4"	8-1/2"	77-1/2"	72"

8" x 9"

Part Number

MC8X9X60

MC8X9X72





Beam Mantel – Rough Sawn

CEDAR

FEATURES:

- Available in 6" x 8" and 8" x 10" (height x projection) with lengths measuring 60"-90", in 6" increments.
- Hardware kit included.



6" x 8" Part Number	8" x 10" Part Number
BMR6X8X60CDR-EC	BMR8X10X60CDR-EC
BMR6X8X66CDR-EC	BMR8X10X66CDR-EC
BMR6X8X72CDR-EC	BMR8X10X72CDR-EC
BMR6X8X78CDR-EC	BMR8X10X78CDR-EC
BMR6X8X84CDR-EC	BMR8X10X84CDR-EC
BMR6X8X90CDR-EC	BMR8X10X90CDR-EC

Decorative Millwork





Beam Mantel – Hand Hewn

ELM



See the product through your mobile device at fypon.com/AR



FEATURES:

- Available in 6" x 8" and 8" x 10" (height x projection) with lengths measuring 60"-90", in 6" increments.
- Hardware kit included.

6" x 8" Part Number	8" x 10" Part Number
BMH6X8X60ELM-EC	BMH8X10X60ELM-EC
BMH6X8X66ELM-EC	BMH8X10X66ELM-EC
BMH6X8X72ELM-EC	BMH8X10X72ELM-EC
BMH6X8X78ELM-EC	BMH8X10X78ELM-EC
BMH6X8X84ELM-EC	BMH8X10X84ELM-EC
BMH6X8X90ELM-EC	BMH8X10X90ELM-EC

Decorative Millwork





Smooth Beam



W x H Nominal Dimensions	Actual Dimensions ¹	Side Wall Thickness ¹	Inside Top Width ¹	Inside Bottom Width ¹
4" x 4"	3-1/2" x 3-1/2"	3/4"	2"	1-1/2"
4" x 6"	3-1/2" x 5-1/2"	3/4"	2"	1-5/8"
6" x 8"	5-1/2" x 7-1/2"	3/4"	4"	3-1/2"
8" x 10"	7-1/2" x 9-1/2"	3/4"	6"	5-3/8"
10" x 12"	9-1/2" x 11-1/2"	3/4"	8"	7-3/8"

BMSMT4X4X96

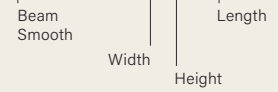

Note: Width and height are nominal, length is actual.

Note: Beam inside dimensions are 1-1/4" wider to accommodate a standard 2" x 2", 2" x 4", 2" x 6", 2" x 8" blocking application.

¹+/- 1/4"

4" x 4" Part Number	4" x 6" Part Number	6" x 8" Part Number	8" x 10" Part Number	10" x 12" Part Number
BMSMT4X4X96	BMSMT4X6X96	BMSMT6X8X96	BMSMT8X10X96	BMSMT10X12X96
BMSMT4X4X120	BMSMT4X6X120	BMSMT6X8X120	BMSMT8X10X120	BMSMT10X12X120
BMSMT4X4X144	BMSMT4X6X144	BMSMT6X8X144	BMSMT8X10X144	BMSMT10X12X144
BMSMT4X4X168	BMSMT4X6X168	BMSMT6X8X168	BMSMT8X10X168	BMSMT10X12X168
BMSMT4X4X192	BMSMT4X6X192	BMSMT6X8X192	BMSMT8X10X192	BMSMT10X12X192
BMSMT4X4X216	BMSMT4X6X216	BMSMT6X8X216	BMSMT8X10X216	BMSMT10X12X216
BMSMT4X4X240	BMSMT4X6X240	BMSMT6X8X240	BMSMT8X10X240	BMSMT10X12X240

Decorative Millwork

Smooth Beam End Cap





Part Number	Nominal	Actual
BCSMT10X15	10" x 15" x 1"	9-5/8" x 14-3/4" x 3/4"





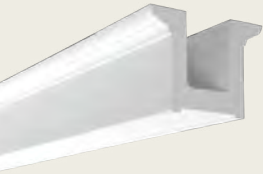

Smooth Classic Beam

	Part Number	Overall Width (A)	Overall Height (B)	Length (C)	Inside Width	Inside Height	
	BM4X5X192	6-5/8"	5"	16'	2"	4"	



Beam – Rough Sawn

CEDAR



W x H Nominal Dimensions	Actual Dimensions ¹	Side Wall Thickness ¹	Inside Top Width ¹	Inside Bottom Width ¹
4" x 6"	3-1/2" x 5-1/2"	3/4"	2"	1-5/8"
6" x 8"	5-1/2" x 7-1/2"	3/4"	4"	3-1/2"
8" x 10"	7-1/2" x 9-1/2"	3/4"	6"	5-3/8"
10" x 12"	9-1/2" x 11-1/2"	3/4"	8"	7-3/8"

Note: Beam inside dimensions are 1-1/4" wider to accommodate a standard 2" x 2", 2" x 4", 2" x 6", 2" x 8" blocking application.

¹+/- 1/4"

BMR4X6X96CDR



Note: Width and height are nominal, length is actual.

4" x 6" Part Number	6" x 8" Part Number	8" x 10" Part Number	10" x 12" Part Number
BMR4X6X96CDR	BMR6X8X96CDR	BMR8X10X96CDR	BMR10X12X96CDR
BMR4X6X120CDR	BMR6X8X120CDR	BMR8X10X120CDR	BMR10X12X120CDR
BMR4X6X144CDR	BMR6X8X144CDR	BMR8X10X144CDR	BMR10X12X144CDR
BMR4X6X168CDR	BMR6X8X168CDR	BMR8X10X168CDR	BMR10X12X168CDR
BMR4X6X192CDR	BMR6X8X192CDR	BMR8X10X192CDR	BMR10X12X192CDR
BMR4X6X216CDR	BMR6X8X216CDR	BMR8X10X216CDR	BMR10X12X216CDR
BMR4X6X240CDR	BMR6X8X240CDR	BMR8X10X240CDR	BMR10X12X240CDR
BMR4X6X264CDR	BMR6X8X264CDR	BMR8X10X264CDR	BMR10X12X264CDR
BMR4X6X288CDR	BMR6X8X288CDR	BMR8X10X288CDR	BMR10X12X288CDR

Decorative Millwork





Beam – Hand Hewn

ELM



W x H Nominal Dimensions	Actual Dimensions ¹	Side Wall Thickness ¹	Inside Top Width ¹	Inside Bottom Width ¹
4" x 6"	3-1/2" x 5-1/2"	3/4"	2"	1-5/8"
6" x 8"	5-1/2" x 7-1/2"	3/4"	4"	3-1/2"
8" x 10"	7-1/2" x 9-1/2"	3/4"	6"	5-3/8"
10" x 12"	9-1/2" x 11-1/2"	3/4"	8"	7-3/8"

Note: Beam inside dimensions are 1-1/4" wider to accommodate a standard 2" x 2", 2" x 4", 2" x 6", 2" x 8" blocking application.

¹+/- 1/4"

BMH4X6X96ELM



Note: Width and height are nominal, length is actual.

Decorative Millwork

4" x 6" Part Number	6" x 8" Part Number	8" x 10" Part Number	10" x 12" Part Number
BMH4X6X96ELM	BMH6X8X96ELM	BMH8X10X96ELM	BMH10X12X96ELM
BMH4X6X120ELM	BMH6X8X120ELM	BMH8X10X120ELM	BMH10X12X120ELM
BMH4X6X144ELM	BMH6X8X144ELM	BMH8X10X144ELM	BMH10X12X144ELM
BMH4X6X168ELM	BMH6X8X168ELM	BMH8X10X168ELM	BMH10X12X168ELM
BMH4X6X192ELM	BMH6X8X192ELM	BMH8X10X192ELM	BMH10X12X192ELM
BMH4X6X216ELM	BMH6X8X216ELM	BMH8X10X216ELM	BMH10X12X216ELM
BMH4X6X240ELM	BMH6X8X240ELM	BMH8X10X240ELM	BMH10X12X240ELM
BMH4X6X264ELM	BMH6X8X264ELM	BMH8X10X264ELM	BMH10X12X264ELM
BMH4X6X288ELM	BMH6X8X288ELM	BMH8X10X288ELM	BMH10X12X288ELM





Beam – Mesa

REDWOOD



W x H Nominal Dimensions	Actual Dimensions ¹	Side Wall Thickness ¹	Inside Top Width ¹	Inside Bottom Width ¹
4" x 6"	3-1/2" x 5-1/2"	3/4"	2"	1-5/8"
6" x 8"	5-1/2" x 7-1/2"	3/4"	4"	3-1/2"
8" x 10"	7-1/2" x 9-1/2"	3/4"	6"	5-3/8"
10" x 12"	9-1/2" x 11-1/2"	3/4"	8"	7-3/8"
10" x 15"	9-1/8" x 14-3/4"	3/4"	7-5/8"	6-5/8"

BMM4X6X96RDW



Note: Width and height are nominal, length is actual.

Note: Beam inside dimensions are 1-1/4" wider to accommodate a standard 2" x 2", 2" x 4", 2" x 6", 2" x 8" blocking application.

¹+/- 1/4"

4" x 6" Part Number	6" x 8" Part Number	8" x 10" Part Number	10" x 12" Part Number	10" x 15" Part Number
BMM4X6X96RDW	BMM6X8X96RDW	BMM8X10X96RDW	BMM10X12X96RDW	BMM10X15X234RDW
BMM4X6X120RDW	BMM6X8X120RDW	BMM8X10X120RDW	BMM10X12X120RDW	—
BMM4X6X144RDW	BMM6X8X144RDW	BMM8X10X144RDW	BMM10X12X144RDW	—
BMM4X6X168RDW	BMM6X8X168RDW	BMM8X10X168RDW	BMM10X12X168RDW	—
BMM4X6X192RDW	BMM6X8X192RDW	BMM8X10X192RDW	BMM10X12X192RDW	—
BMM4X6X216RDW	BMM6X8X216RDW	BMM8X10X216RDW	BMM10X12X216RDW	—
BMM4X6X240RDW	BMM6X8X240RDW	BMM8X10X240RDW	BMM10X12X240RDW	—
BMM4X6X264RDW	BMM6X8X264RDW	BMM8X10X264RDW	BMM10X12X264RDW	—
BMM4X6X288RDW	BMM6X8X288RDW	BMM8X10X288RDW	BMM10X12X288RDW	—

Decorative Millwork



MESA



Beam – Tahoe

CEDAR



W x H Nominal Dimensions	Actual Dimensions ¹	Side Wall Thickness ¹	Inside Top Width ¹	Inside Bottom Width ¹
4" x 6"	3-1/2" x 5-1/2"	3/4"	2"	1-5/8"
6" x 8"	5-1/2" x 7-1/2"	3/4"	4"	3-1/2"
8" x 10"	7-1/2" x 9-1/2"	3/4"	6"	5-3/8"
10" x 12"	9-1/2" x 11-1/2"	3/4"	8"	7-3/8"

Note: Beam inside dimensions are 1-1/4" wider to accommodate a standard 2" x 2", 2" x 4", 2" x 6", 2" x 8" blocking application.

¹+/- 1/4"

BMT4X6X96CDR

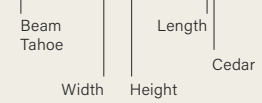

Note: Width and height are nominal, length is actual.

Decorative Millwork

4" x 6" Part Number	6" x 8" Part Number	8" x 10" Part Number	10" x 12" Part Number
BMT4X6X96CDR	BMT6X8X96CDR	BMT8X10X96CDR	BMT10X12X96CDR
BMT4X6X120CDR	BMT6X8X120CDR	BMT8X10X120CDR	BMT10X12X120CDR
BMT4X6X144CDR	BMT6X8X144CDR	BMT8X10X144CDR	BMT10X12X144CDR
BMT4X6X168CDR	BMT6X8X168CDR	BMT8X10X168CDR	BMT10X12X168CDR
BMT4X6X192CDR	BMT6X8X192CDR	BMT8X10X192CDR	BMT10X12X192CDR
BMT4X6X216CDR	BMT6X8X216CDR	BMT8X10X216CDR	BMT10X12X216CDR
BMT4X6X240CDR	BMT6X8X240CDR	BMT8X10X240CDR	BMT10X12X240CDR
BMT4X6X264CDR	BMT6X8X264CDR	BMT8X10X264CDR	BMT10X12X264CDR
BMT4X6X288CDR	BMT6X8X288CDR	BMT8X10X288CDR	BMT10X12X288CDR



Beam – Milled

SMOOTH CEDAR



Part Number	Overall Width	Overall Height	Length	Inside Width	Inside Height
BMCDR8X6X168S	7-1/4"	5-3/4"	14'	5-3/4"	5"



Beam Top

MESA



Beam with top shown.

Part Number	Nominal	Actual
BTM6X144	6" x 1" x 144"	5-1/2" x 3/4" x 144"
BTM8X144	8" x 1" x 144"	7-1/2" x 3/4" x 144"

Beam End Cap



Beam with end cap shown.

Part Number	Nominal	Actual
BC10X15	10" x 15" x 1"	9-1/8" x 15-5/8" x 3/4"

Beam Straps

SMOOTH

Part Number	Beam Size	Nut & Bolt Qty
BMSTRPS4X6	4" x 6"	4
BMSTRPS6X8	6" x 8"	4
BMSTRPS8X10	8" x 10"	6
BMSTRPS10X12	10" x 12"	6
BMSTRPS10X15	10" x 15"	6

Note: Beam straps sold as set of two.

Beam Straps

HAMMERED

Part Number	Beam Size	Nut & Bolt Qty
BMSTRPH4X6	4" x 6"	4
BMSTRPH6X8	6" x 8"	4
BMSTRPH8X10	8" x 10"	6
BMSTRPH10X12	10" x 12"	6
BMSTRPH10X15	10" x 15"	6

Note: Beam straps sold as set of two.

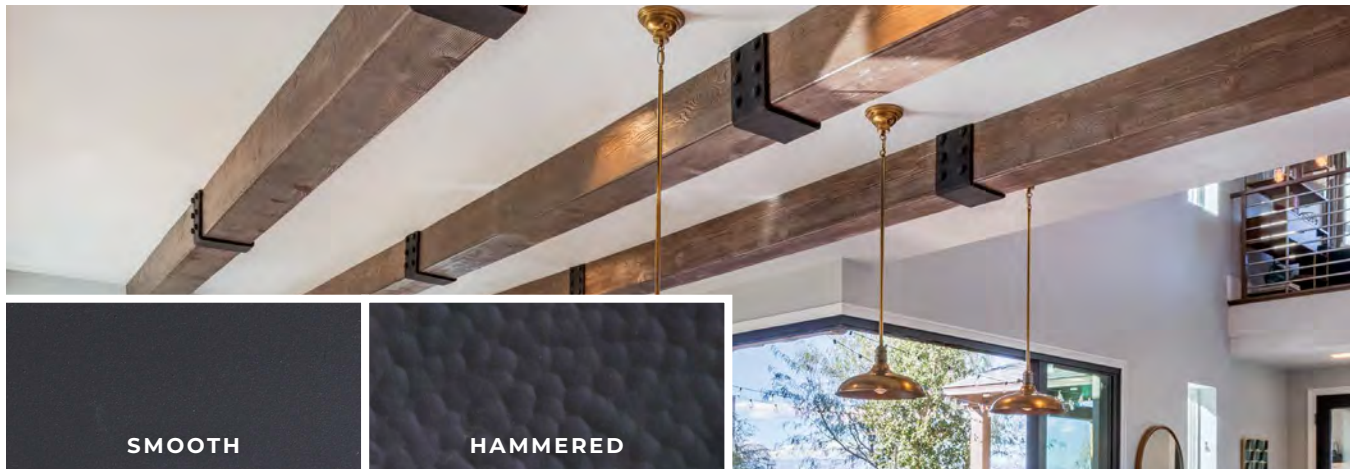

Beam Plates

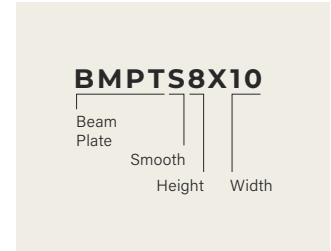

SMOOTH

	Part Number
	BMPTS8X10 ¹



Beam Plates

HAMMERED

	Part Number
	BMPTH8X10 ¹
	BMPTH15X20 ¹

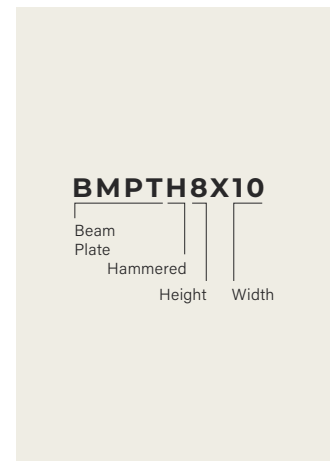

Beam Mantel Accessories

HARDWARE KIT

	Part Number	Quantity (Plates)	Quantity (Screws)
	MTLINSTALLKIT	4	24

¹Four parts per package (two front and two back plates). Nuts and bolts are molded into the beam plate. Quantity is dependent on size of the plate.

Burnham Gable Pediments



See the product through your mobile device at fypon.com/AR

WOOD-GRAINED

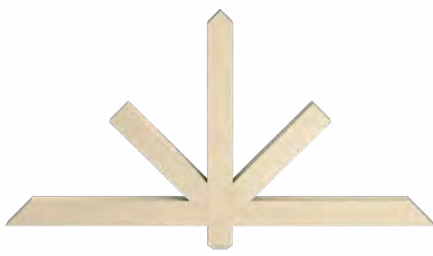

Chamfered End

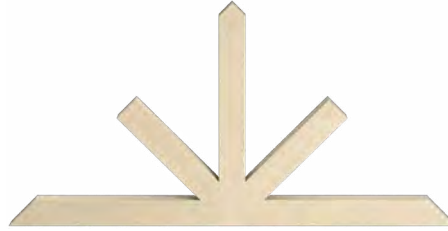

Without Chamfered End

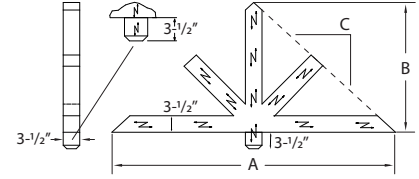

Decorative Millwork

Part Number with Chamfered End	Part Number without Chamfered End	Overall Width (A)	Height (B)	Pitch (C)
GBPBC60X15X3.5RS	—	60"	15"	6 / 12
GBPBC60X17.5X3.5RS	—	60"	17-1/2"	7 / 12
—	GBPBC60X17.5X3.5RS	60"	17-1/2"	7 / 12
—	GBPBC60X20X3.5RS	60"	20"	8 / 12
GBPBC60X22.5X3.5RS	—	60"	22-1/2"	9 / 12
—	GBPBC60X25X3.5RS	60"	25"	10 / 12
GBPBC60X27.5X3.5RS	GBPBC60X27.5X3.5RS	60"	27-1/2"	11 / 12
GBPBC60X30X3.5RS	GBPBC60X30X3.5RS	60"	30"	12 / 12
GBPBC72X15X3.5RS	GBPBC72X15X3.5RS	72"	15"	5 / 12
GBPBC72X18X3.5RS	—	72"	18"	6 / 12
GBPBC72X21X3.5RS	GBPBC72X21X3.5RS	72"	21"	7 / 12
—	GBPBC72X24X3.5RS	72"	24"	8 / 12
—	GBPBC72X30X3.5RS	72"	30"	10 / 12
GBPBC72X36X3.5RS	GBPBC72X36X3.5RS	72"	36"	12 / 12
GBPBC84X17.5X3.5RS	GBPBC84X17.5X3.5RS	84"	17-1/2"	5 / 12
—	GBPBC84X21X3.5RS	84"	21"	6 / 12
—	GBPBC84X28X3.5RS	84"	28"	8 / 12
GBPBC84X35X3.5RS	—	84"	35"	10 / 12
—	GBPBC96X20X3.5RS	96"	20"	5 / 12
GBPBC96X24X3.5RS	GBPBC96X24X3.5RS	96"	24"	6 / 12
GBPBC96X28X3.5RS	GBPBC96X28X3.5RS	96"	28"	7 / 12
GBPBC96X32X3.5RS	GBPBC96X32X3.5RS	96"	32"	8 / 12
GBPBC96X36X3.5RS	GBPBC96X36X3.5RS	96"	36"	9 / 12



Part Number with Chamfered End	Part Number without Chamfered End	Overall Width (A)	Height (B)	Pitch (C)
—	GBPB96X40X3.5RS	96"	40"	10 / 12
GBPBC96X44X3.5RS	GBPB96X44X3.5RS	96"	44"	11 / 12
—	GBPB96X48X3.5RS	96"	48"	12 / 12
—	GBPB108X27X3.5RS	108"	27"	6 / 12
GBPBC108X31.5X3.5RS	—	108"	31-½"	7 / 12
GBPBC108X36X3.5RS	—	108"	36"	8 / 12
GBPBC108X40.5X3.5RS	GBPB108X40.5X3.5RS	108"	40-½"	9 / 12
—	GBPB108X49.5X3.5RS	108"	49-½"	11 / 12
—	GBPB108X54X3.5RS	108"	54"	12 / 12

Meier Gable Pediments



See the product through your mobile device at fypon.com/AR

WOOD-GRAINED



Chamfered End

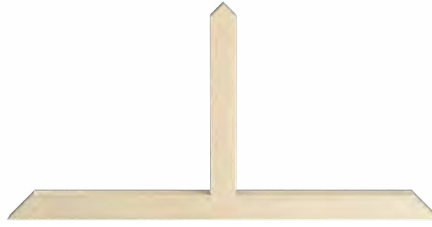

Without Chamfered End

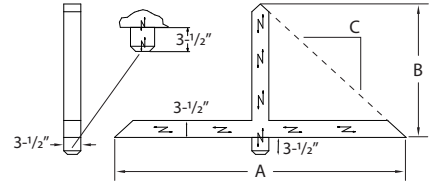

Part Number with Chamfered End	Part Number without Chamfered End	Overall Width (A)	Height (B)	Pitch (C)
GBPMC60X12.5X3.5RS	GBPM60X12.5X3.5RS	60"	12-1/2"	5 / 12
—	GBPM60X15X3.5RS	60"	15"	6 / 12
GBPMC60X17.5X3.5RS	GBPM60X17.5X3.5RS	60"	17-1/2"	7 / 12
—	GBPM60X20X3.5RS	60"	20"	8 / 12
GBPMC60X22.5X3.5RS	—	60"	22-1/2"	9 / 12
GBPMC60X27.5X3.5RS	GBPM60X27.5X3.5RS	60"	27-1/2"	11 / 12
GBPMC72X15X3.5RS	GBPM72X15X3.5RS	72"	15"	5 / 12
—	GBPM72X18X3.5RS	72"	18"	6 / 12
GBPMC72X24X3.5RS	—	72"	24"	8 / 12
GBPMC72X27X3.5RS	GBPM72X27X3.5RS	72"	27"	9 / 12
GBPMC72X30X3.5RS	—	72"	30"	10 / 12
GBPMC72X33X3.5RS	GBPM72X33X3.5RS	72"	33"	11 / 12
GBPMC72X36X3.5RS	—	72"	36"	12 / 12
—	GBPM84X17.5X3.5RS	84"	17-1/2"	5 / 12
GBPMC84X21X3.5RS	GBPM84X21X3.5RS	84"	21"	6 / 12
GBPMC84X24.5X3.5RS	—	84"	24-1/2"	7 / 12
—	GBPM84X28X3.5RS	84"	28"	8 / 12
GBPMC84X31.5X3.5RS	GBPM84X31.5X3.5RS	84"	31-1/2"	9 / 12
—	GBPM84X35X3.5RS	84"	35"	10 / 12
GBPMC84X38.5X3.5RS	GBPM84X38.5X3.5RS	84"	38-1/2"	11 / 12
GBPMC84X42X3.5RS	—	84"	42"	12 / 12
—	GBPM96X20X3.5RS	96"	20"	5 / 12
GBPMC96X28X3.5RS	—	96"	28"	7 / 12
GBPMC96X32X3.5RS	GBPM96X32X3.5RS	96"	32"	8 / 12



Part Number with Chamfered End	Part Number without Chamfered End	Overall Width (A)	Height (B)	Pitch (C)
GBPMC96X36X3.5RS	—	96"	36"	9 / 12
GBPMC96X40X3.5RS	GBPM96X40X3.5RS	96"	40"	10 / 12
GBPMC96X44X3.5RS	GBPM96X44X3.5RS	96"	44"	11 / 12
GBPMC96X48X3.5RS	—	96"	48"	12 / 12
—	GBPM108X22.5X3.5RS	108"	22-½"	5 / 12
GBPMC108X27X3.5RS	—	108"	27"	6 / 12
GBPMC108X31.5X3.5RS	GBPM108X31.5X3.5RS	108"	31-½"	7 / 12
—	GBPM108X40.5X3.5RS	108"	40-½"	9 / 12
—	GBPM108X45X3.5RS	108"	45"	10 / 12
—	GBPM108X49.5X3.5RS	108"	49-½"	11 / 12
GBPMC108X54X3.5RS	GBPB108X54X3.5RS	108"	54"	12 / 12

Note: Wood-grained gable pediments are not textured on their structure-facing side.

Sullivan Gable Pediment



See the product through your mobile device at fypon.com/AR

WOOD-GRAINED WITH CHAMFERED END

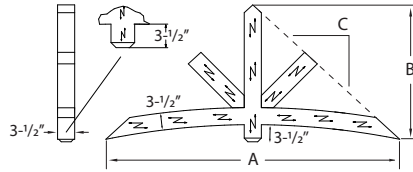
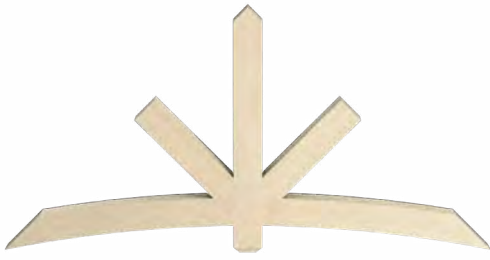

Part Number	Overall Width (A)	Overall Height (B)	Pitch (C)
GBPSC60X22.5X3.5RS	60"	22-1/2"	9 / 12
GBPSC60X25X3.5RS	60"	25"	10 / 12
GBPSC60X27.5X3.5RS	60"	27-1/2"	11 / 12
GBPSC60X30X3.5RS	60"	30"	12 / 12
GBPSC84X28X3.5RS	84"	28"	8 / 12
GBPSC84X35X3.5RS	84"	35"	10 / 12
GBPSC84X38.5X3.5RS	84"	38-1/2"	11 / 12
GBPSC84X42X3.5RS	84"	42"	12 / 12

Decorative Millwork



Asher Gable Pediment

See the product through your mobile device at fypon.com/AR

WOOD-GRAINED WITH CHAMFERED END

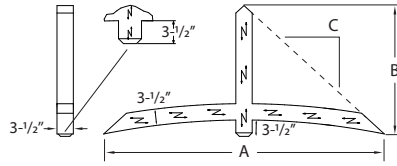
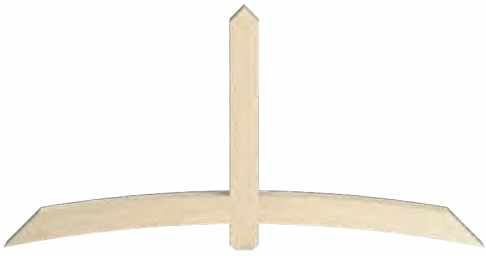

Part Number	Overall Width (A)	Overall Height (B)	Pitch (C)
GBPAC60X22.5X3.5RS	60"	22-1/2"	9 / 12
GBPAC84X31.5X3.5RS	84"	31-1/2"	9 / 12
GBPAC84X38.5X3.5RS	84"	38-1/2"	11 / 12
GBPAC108X40.5X3.5RS	108"	40-1/2"	9 / 12



Note: Wood-grained gable pediments are not textured on their structure-facing side.

Flat Gable Pediment

WOOD-GRAINED

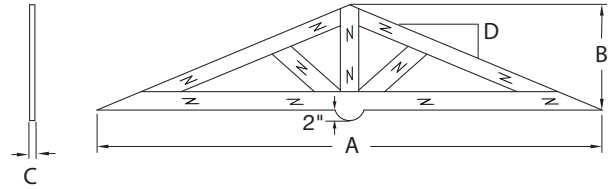
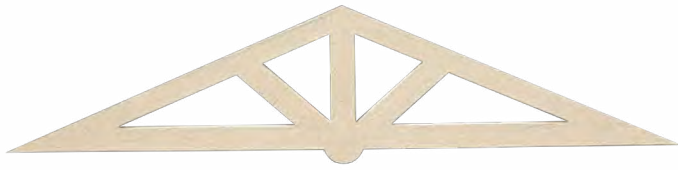

Part Number	Width (A)	Height (B)	Projection (C)	Pitch (D)
GPF96X20RS	96"	20"	1"	5 / 12
GPF96X24RS	96"	24"	1"	6 / 12

Decorative Millwork



Flat Gable Pediment

SMOOTH

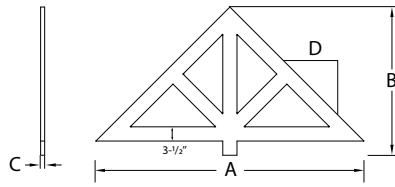
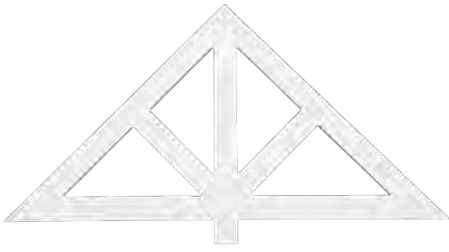

Part Number	Overall Width (A)	Overall Height (B)	Projection (C)	Pitch (D)
GPF66X22	66"	22"	1"	8 / 12
GPF66X24.75	66"	24-3/4"	1"	9 / 12
GPF66X27.5	66"	27-1/2"	1"	10 / 12
GPF66X33	66"	33"	1"	12 / 12



Victorian Gable Pediment

SMOOTH

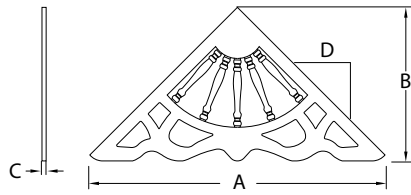

Part Number	Overall Width (A)	Overall Height (B)	Projection (C)	Pitch (D)
GP64X32	62"	32-1/4"	1"	12 / 12
GP80X33	80-1/4"	33-3/4"	1"	10 / 12
GP88X29	86-3/8"	29-3/8"	1"	8 / 12
GP96X28	96"	28"	1"	7 / 12

Decorative Millwork



Arched Gable Pediment

SMOOTH

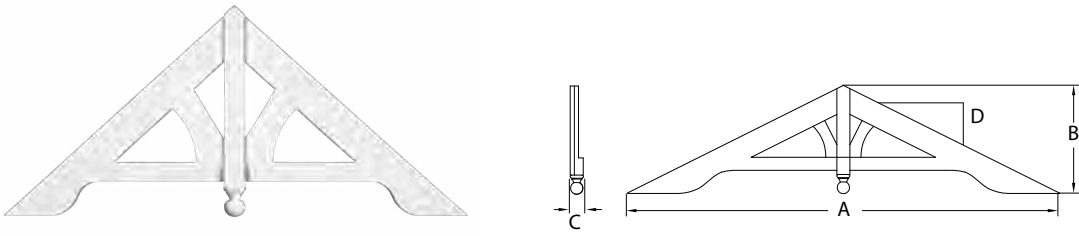

Part Number	Overall Width (A)	Overall Height (B)	Projection (C)	Pitch (D)
GPA70X35	70"	35"	3-1/4"	12 / 12
GPA81X34	80-1/2"	33-1/2"	3-1/4"	10 / 12
GPA86X32	85-1/4"	32-1/4"	3-1/4"	9 / 12
GPA87X29	86-7/8"	29"	3-1/4"	8 / 12
GPA95X28	95-1/4"	27-3/4"	3-1/4"	7 / 12
GPA104X26	103-1/2"	25-7/8"	3-1/4"	6 / 12

Gable Pediment Kits

BASIC SYSTEM







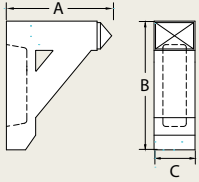

Part Number	Base Width (A)	Overall Height (B)	Thickness	Pitch
GPK100 ¹	96"	48"	1-1/4"	Adjustable from 6 / 12 to 12 / 12

¹Ships in six pieces; field trimming and assembly required. Installation hardware and instructions included.

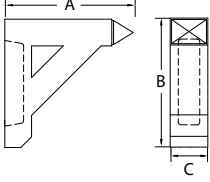
Smooth Brackets

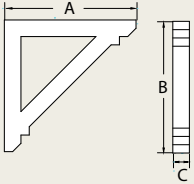
FLAT

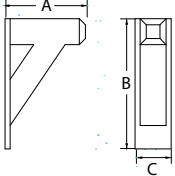

	Part Number	Projection (A)	Height (B)	Overall Width (C)	
	BKT9X11	9"	11"	3-1/2"	
	BKT12X12X4	12"	12"	3-1/2"	
	BKT14X14X4	14"	14"	3-1/2"	
	BKT18X18X4	18"	18"	3-1/2"	
	See the product through your mobile device at fypon.com/AR				
	BKT16X16	15-7/8"	15-7/8"	2"	
	BKT10X16X4	9-7/8"	16"	4-1/2"	

Decorative Millwork



Smooth Brackets

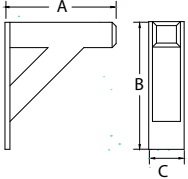
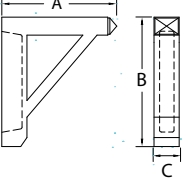







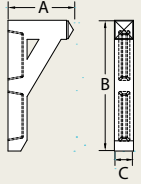

FLAT

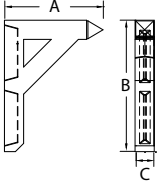
	Part Number	Projection (A)	Height (B)	Overall Width (C)	
	BKT12X16	11-1/2"	16"	3"	
	BKT14X16X4	14"	16"	4-1/2"	
	BKT17X17	16-1/2"	16-1/2"	3-1/2"	
	BKT16X18X3	16"	18"	3-1/2"	
	BKT11X20	11"	20"	3-1/8"	

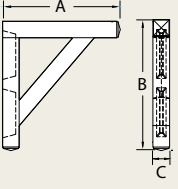

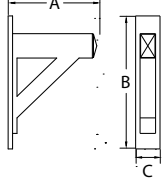
Smooth Brackets

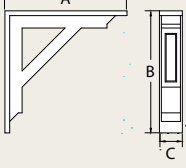
FLAT

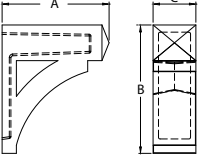





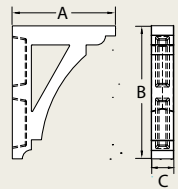

	Part Number	Projection (A)	Height (B)	Overall Width (C)	
	BKT12X24X3	12"	24"	3-1/2"	
	BKT18X24X4	18"	24"	3-1/2"	
	BKT18X30X4	18"	30"	3-1/2"	
	BKT25X27	25"	27-1/2"	3-1/2"	
	BKT36X36X4	36"	36"	4"	
	BKT36X36X6	36"	36"	6"	
	BKT20X30X6	20"	30"	5-1/2"	
	BKT32X32	32"	32"	6"	
	BKT40X40	40"	40"	6"	
	BKT15X18X6	15"	18"	6"	

Decorative Millwork

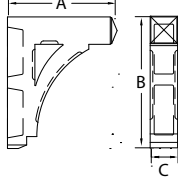

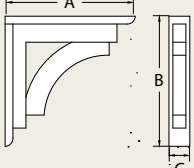
Smooth Brackets

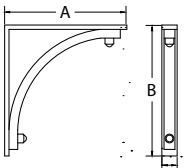
COVE / ARCH

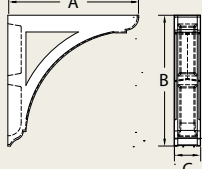

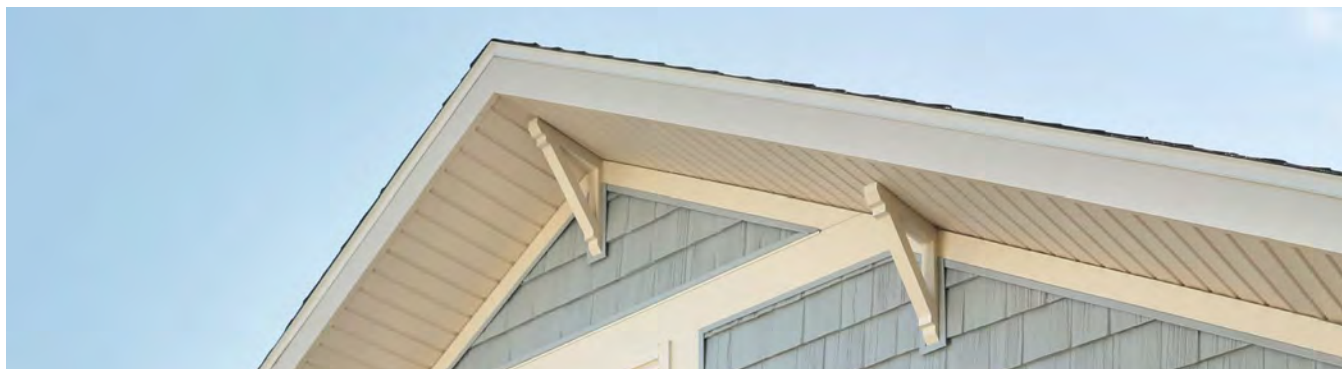





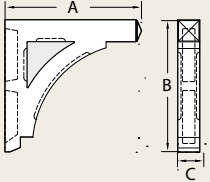

	Part Number	Projection (A)	Height (B)	Overall Width (C)	
	BKT19X24X4	18-5/8"	24"	4"	
	BKT19X36X4	19"	36"	4"	
	BKT20X24X5	20"	24"	5"	
	BKT25X25	25"	25"	4"	
	BKT28X30	28"	30"	3-1/2"	
	BKT30X30	30"	30"	6"	
	BKT36X36	36-1/8"	36-1/8"	6"	

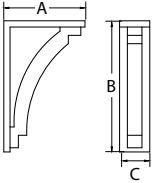

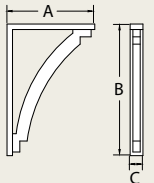
Smooth Brackets

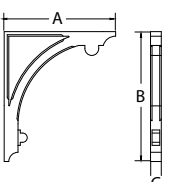
COVE / ARCH

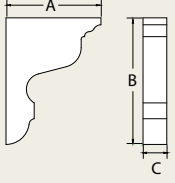
Decorative Millwork

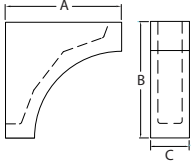
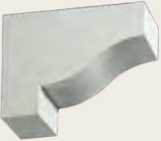
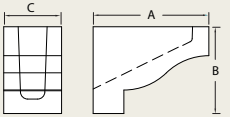





	Part Number	Projection (A)	Height (B)	Overall Width (C)	
	BKT31X30X5	31"	30"	5"	
	BKT19X31	19-1/2"	31-1/2"	7-1/4"	
	BKT24X36	24"	36"	3-1/2"	
	BKT36X42	36-1/4"	42-1/4"	3-1/2"	
	BKT6X8	6"	8"	1-1/2"	
	DTLB5X5X3	5-1/2"	5-1/2"	3-1/2"	
	BKT8X8	8"	8"	2"	
	BKT12X12X4CV	12"	12"	4"	
	BKT24X24X8CV	24"	24"	8"	
	BKT8X6	8"	6"	4"	

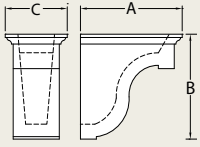

See the product through your mobile device at fypon.com/AR

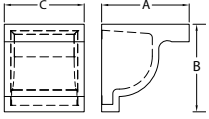
Smooth Brackets

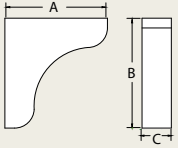

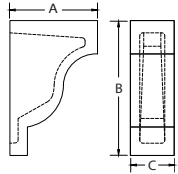







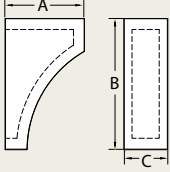

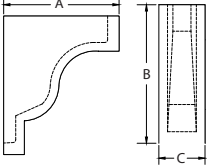
COVE / ARCH

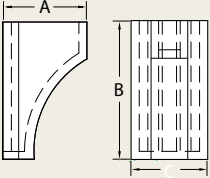
	Part Number	Projection (A)	Height (B)	Overall Width (C)	
	BKT8X8X4	8"	8"	4-7/8"	
	BKT10X10X9	10"	10"	9-1/8"	
	BKT10X11	10-1/2"	11-1/4"	3"	
	BKT7X11X3	7"	11"	3-1/2"	

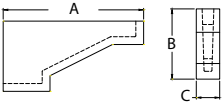

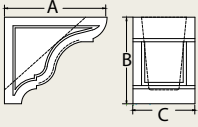



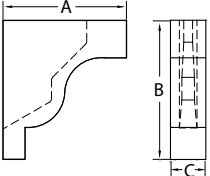

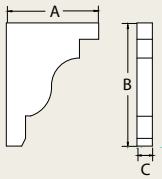

Smooth Brackets

COVE / ARCH

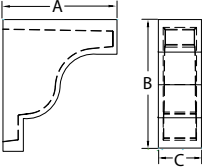
	Part Number	Projection (A)	Height (B)	Overall Width (C)	
	BKT7X12X4	7-1/4"	12"	4"	
	BKT10X12X4	10"	12"	4"	
	BKT8X13	8"	13"	7-1/4"	
	BKT18X9X3	18"	9"	3"	
	BKT12X10 Recessed	12"	10-1/8"	7-1/4"	
	BKT18X10 Recessed	18"	10-1/8"	7-1/4"	
	BKT24X24X12 Recessed	24"	24"	12"	
	BKT14X16	14"	15-3/4"	4"	

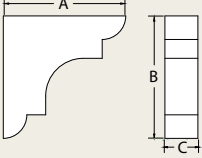
Smooth Brackets

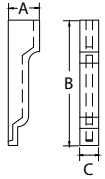
COVE / ARCH

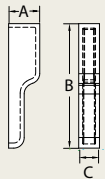
	Part Number	Projection (A)	Height (B)	Overall Width (C)	
	BKT18X24X3	18"	24"	3"	
	BKT22X26	22-1/2"	26"	8-1/2"	
	BKT13X13X3	13"	13"	3-1/2"	
	BKT5X20	5"	20"	3"	
	BKT6X24	6"	24"	4"	









Smooth Brackets

DECORATIVE

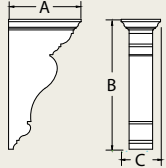
	Part Number	Projection (A)	Height (B)	Overall Width (C)	
	BKT5X8X6	7-7/8"	5"	5-3/4"	
	BKT9X13	9"	13"	3"	
	BKT11X15	11"	15"	3"	
	BKT5X10	5-1/4"	10"	4"	
	BKT10X16X6	10"	16"	6"	
	BKT10.5X20X6	10-1/2"	20"	6"	
	 See the product through your mobile device at fypon.com/AR				
	BKT8X15	7-7/8"	14-7/8"	8-1/4"	
	BKT11X16	10-1/2"	16-1/4"	4-3/16"	
	BKT4X18X4	4"	18"	4"	
	BKT6X24X6	6"	24"	6"	

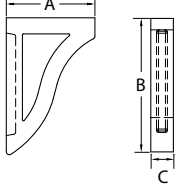
Smooth Brackets

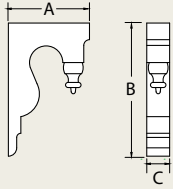
DECORATIVE

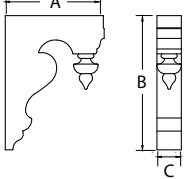





	Part Number	Projection (A)	Height (B)	Overall Width (C)	
	BKT15X28	15-3/8"	27-1/2"	8-3/8"	
	BKT11X17	11"	17"	2-7/8"	
	BKT10X16	9-3/4"	16"	2-3/4"	
	BKT12X17	12-1/8"	16-1/2"	3"	



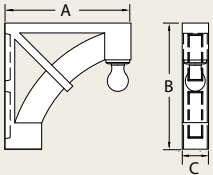

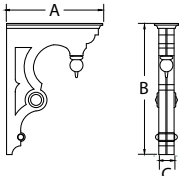

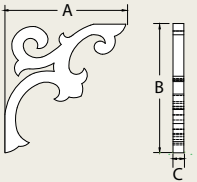

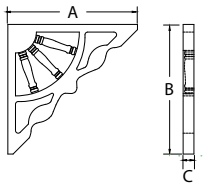





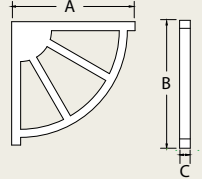
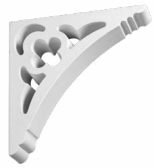
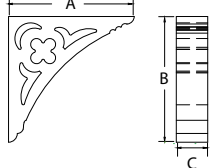

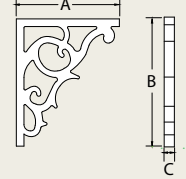
Smooth Brackets

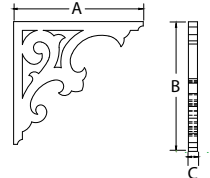
DECORATIVE

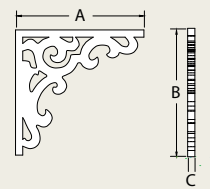
	Part Number	Projection (A)	Height (B)	Overall Width (C)	
	BKT24X24X5	24"	24"	5"	
	BKT22X30	22"	30"	5-1/2"	
	BKT12X12	12-1/4"	11-1/2"	1-1/8"	
	BKT12X12GP	12"	12"	1"	

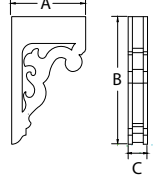
Smooth Brackets

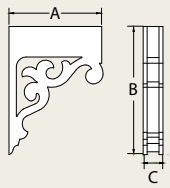
DECORATIVE

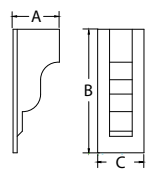
	Part Number	Projection (A)	Height (B)	Overall Width (C)	
	BKT12X12WW	12"	12"	1"	
	BKT12X12X3	12"	12"	3"	
	BKT22X21	21-3/4"	21-1/2"	3"	
	BKT10X12	10-1/8"	12-1/2"	1"	
	BKT14X15	14"	14-3/4"	1"	
	BKT19X20	19-1/2"	20"	1-1/8"	
	BKT12X21X3	12-1/4"	21-1/8"	3-1/4"	
	BKT16X23X3	16-3/8"	22-3/4"	3-1/2"	
	BKT11X30	11-1/4"	30"	11-1/4"	

Smooth Brackets

DECORATIVE





	Part Number	Projection (A)	Height (B)	Overall Width (C)	
	BKT5X4	20-1/2"	4-3/8"	4-3/8"	
	BKT5X5X9	8-3/4"	5-3/8"	4-7/8"	
	BKT13X6	13-1/4"	5-3/4"	5-7/8"	
	BKT7X6X12	11-1/2"	6-3/4"	5-1/2"	
	BKT8X7X18	18"	7-3/8"	7"	
	BKT8X9X14	14"	8"	9"	

Decorative Millwork

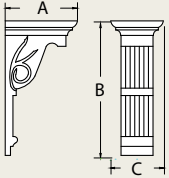

Smooth Brackets

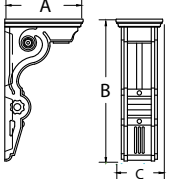
ORNATE

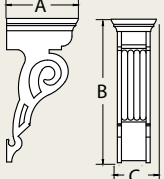







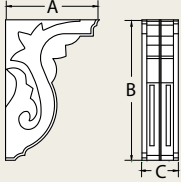

	Part Number	Projection (A)	Height (B)	Overall Width (C)	
	BKT11X20X8	11"	20-1/2"	8"	
	BKT23X26	22-1/2"	26"	8-1/2"	
	BKT18X35	17-1/2"	35"	11"	

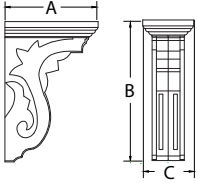

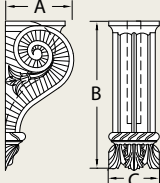
Note: BKT10X14 is used with F100 to build up bracket detail in photo.

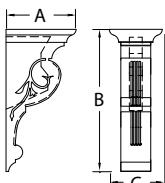

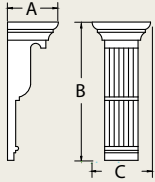

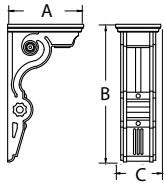
Smooth Brackets

ORNATE

	Part Number	Projection (A)	Height (B)	Overall Width (C)	
	BKT10X14	9-3/4"	14-1/2"	3-3/4"	
	BKT11X16X6	11"	16-1/4"	6"	
	BKT7X16	7-1/2"	16-1/4"	5-1/2"	
	BKT8X17	8-1/4"	16-5/8"	6-1/4"	
	BKT7X18	6-3/4"	18-1/4"	7-3/4"	
	BKT11X20X6	11"	20"	6-1/2"	
	BKT14X26	14-1/2"	26"	6-1/2"	

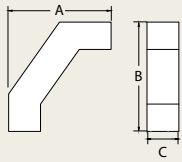

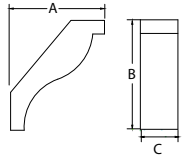

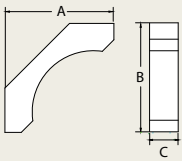

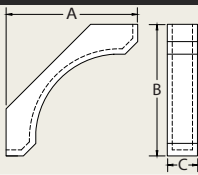

Smooth Knee Braces

FLAT

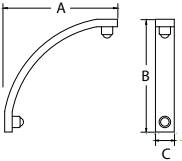
	Part Number	Projection (A)	Height (B)	Overall Width (C)	
	BKT11X12X3	11-1/4"	12"	3-1/2"	
	BKT13X15	12-1/2"	14-5/8"	5"	
	BKT14X14	13-1/4"	13-1/4"	3-1/2"	

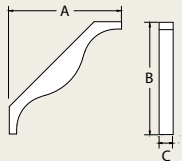

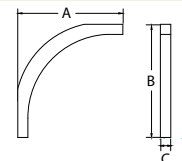

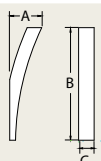

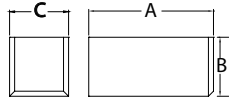

Smooth Knee Braces

DECORATIVE

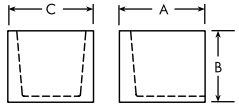
	Part Number	Projection (A)	Height (B)	Overall Width (C)	
	BKT30X30X8	30"	30"	6-7/8"	
	BKT15X15	15"	15"	2-1/2"	
	BKT22X22	22"	22"	2-3/4"	
	BKT26X28	26"	28"	2-1/2"	
	BKT8X29X4	8-1/4"	29"	4"	

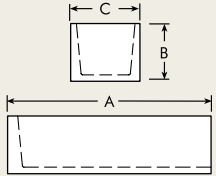
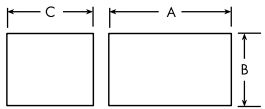

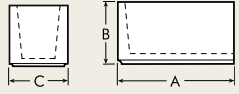
Smooth Dentil Blocks

FLAT

	Part Number	Projection (A)	Height (B)	Overall Width (C)	
	DTLB3X3X3	3-1/2"	3-1/2"	3-1/2"	
	DTLB3.5X3.5X7	7-3/8"	3-1/2"	3-1/2"	
	DTLB4X6X9	8-3/4"	4-1/4"	6"	
	DTLB5X6X6	6"	5"	6"	
	DTLB5X6X18	17-5/8"	5"	6"	
	DTLB5X6X8	8-1/2"	5"	6"	
	F100	10-3/8"	5-1/2"	5"	
	DTLB5X5X3	5-1/2"	5-1/2"	3-1/2"	

Smooth Dentil Blocks

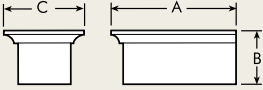

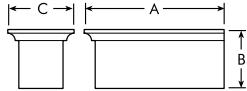
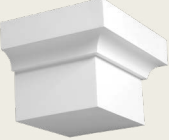
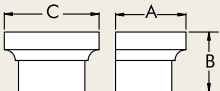

DECORATIVE

	Part Number	Projection (A)	Height (B)	Overall Width (C)	
	DTLB4X5X8	7-3/4"	3-3/8"	5"	
	DTLB5X6X10	9-1/2"	4-3/4"	5-7/8"	
	DTLB6X9X7	6-1/2"	5-1/2"	8-3/4"	

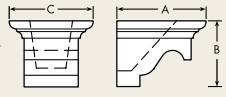

Smooth Dentil Blocks

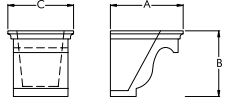

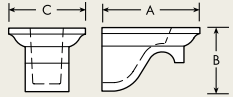



DECORATIVE

	Part Number	Projection (A)	Height (B)	Overall Width (C)	
	DTLB4X6X6	6-1/4"	4-1/2"	5-3/4"	
	DTLB6X6X9	9-3/8"	5-3/4"	5-1/2"	
	DTLB9X8X8	9"	8-1/8"	8-1/8"	
	DTLB6X7X9	9-1/4"	6"	7-1/4"	

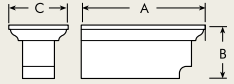

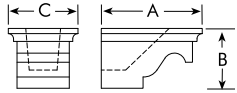
Smooth Dentil Blocks

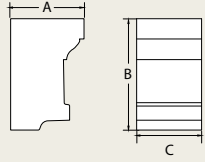

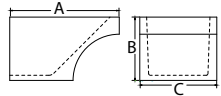
DECORATIVE

	Part Number	Projection (A)	Height (B)	Overall Width (C)	
	DTLB4X4X9	9"	3-7/8"	4-3/8"	
	DTLB4X4X7	7-1/4"	4-3/8"	5"	
	DTLB5X8	5-7/16"	8-1/4"	4-13/16"	
	DTLB9X11X16	16"	9-1/4"	11-1/4"	

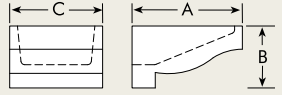
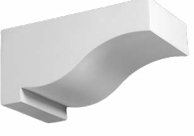
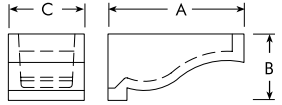
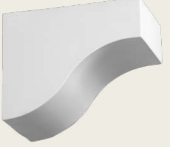
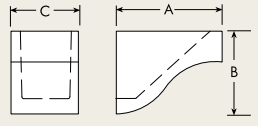

Smooth Dentil Blocks

ASSORTED

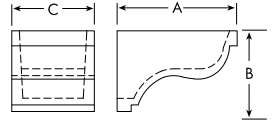





	Part Number	Projection (A)	Height (B)	Overall Width (C)	
	DTLB4X6X7	7-1/8"	4"	6"	
	DTLB5X6X11	10-3/4"	5-1/4"	6"	
	DTLB5X4X7	6-7/8"	5-3/8"	4-3/8"	
	DTLB6X6X8	8"	5-3/8"	5-1/2"	

Decorative Millwork

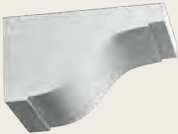
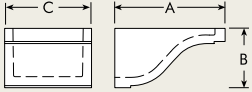

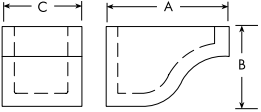
Smooth Dentil Blocks

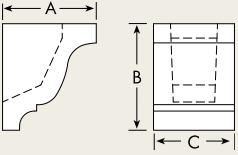

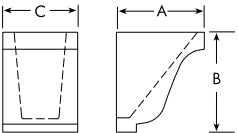
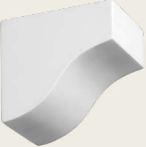
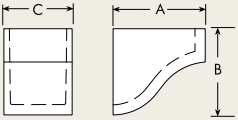
ASSORTED

	Part Number	Projection (A)	Height (B)	Overall Width (C)	
	DTLB5X8X10	10"	5-3/8"	7-7/8"	
	DTLB6X6X9.25	9-1/4"	6"	6"	
	DTLB6X4X6	5-1/2"	6-1/8"	4-3/4"	
	BKT12X12X4SC	12"	12"	4"	
	DTLB6X6X5	5-1/2"	6-1/4"	4-3/4"	
	DTLB6X5X7	6-3/4"	6-5/16"	5"	

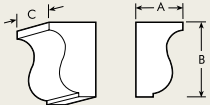

Smooth Dentil Blocks

ASSORTED

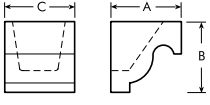
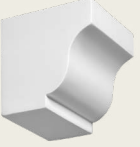
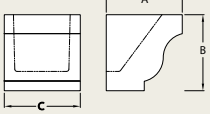
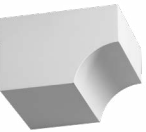
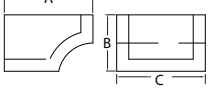

	Part Number	Projection (A)	Height (B)	Overall Width (C)	
	DTLB8X6X6	5-3/16"	8-1/8"	5-1/2"	
	DTLB3X3X4	4-1/2"	3-3/4"	3-3/4"	
	DTLB4X5X7	7-3/4"	4-1/4"	5-1/8"	
	DTLB4X4X4	4"	4"	4"	
	DTLB3.5X5.5X5.5	5-1/2"	3-1/2"	5-1/2"	

Decorative Millwork

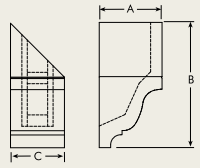

Smooth Dentil Blocks

ASSORTED

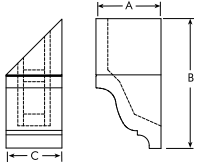
	Part Number	Projection (A)	Height (B)	Overall Width (C)	Pitch (D)	
	DTLB6X4X6R12	5-1/2"	11"	4-3/4"	12 / 12	
	DTLB6X4X6L12	5-1/2"	10-15/16"	4-3/4"	12 / 12	



Wood-Grained Brackets

FLAT

Decorative Millwork

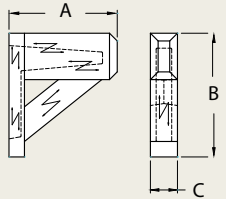
	Part Number	Projection (A)	Height (B)	Overall Width (C)	
	BKT14X16X3.5S	14"	16"	3-1/2"	

BKT14X16X6S	14"	16"	5-1/2"
-------------	-----	-----	--------

BKT18X18X4S	18"	18"	3-1/2"
-------------	-----	-----	--------

BKT22X24X4S-1	22"	24"	3-1/2"
---------------	-----	-----	--------

BKT22X24X6S	22"	24"	5-1/2"
-------------	-----	-----	--------

BKT26X24X6S	26"	24"	5-1/2"
-------------	-----	-----	--------

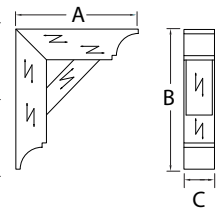

See the product through your mobile device at fypon.com/AR

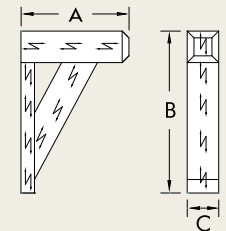
	BKT12X18X3X1S ¹	12"	18"	3-1/2"	
	BKT18X18X3X1S	18"	18"	3-1/2"	
	BKT18X30X4S	18"	30"	3-1/2"	
	BKT36X36X6S	36"	36"	5-1/2"	







See the product through your mobile device at fypon.com/AR

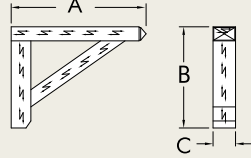

Wood-Grained Brackets

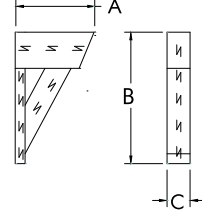
FLAT

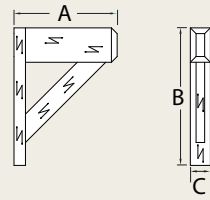





	Part Number	Projection (A)	Height (B)	Overall Width (C)	
	BKT24X18X4S	24"	18"	4"	
	BKT12X20X3S	12"	20"	3-1/2"	
	BKT18X24X3X2S	18"	24"	3-1/2"	

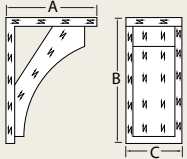

*Product has an open cavity.

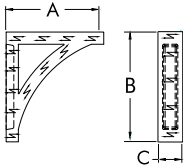
Wood-Grained Brackets

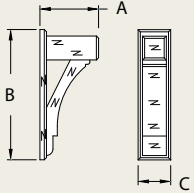
COVE / ARCH

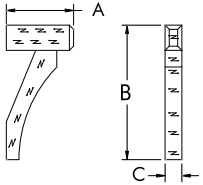
	Part Number	Projection (A)	Height (B)	Overall Width (C)	
	BKT13X18X8S	13"	18"	8"	
	BKT16X18X4S	16"	18"	4"	
	BKT14X30X7.5S	13-1/2"	30"	7-1/2"	
	BKT22X30X8S	21-1/2"	30"	7-1/2"	
	BKT16X32X4S	16"	32"	4"	

Decorative Millwork



Wood-Grained Knee Brace

FLAT

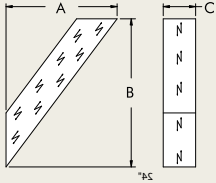
	Part Number	Projection (A)	Height (B)	Overall Width (C)
	BKTS18X24X6S	18"	24"	5-1/2"
				



Wood-Grained Knee Braces

COVE / ARCH

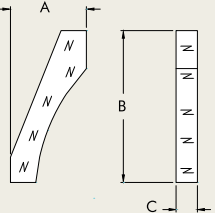
	Part Number	Projection (A)	Height (B)	Overall Width (C)	
	BKT12X24X3S	12"	24"	3-3/8"	
	BKTCV18X24X4S	18"	24"	3-1/4"	
	BKTCV18X24X6S	18"	24"	5-1/4"	
	BKTCV21X30X6S	21"	30"	5-1/4"	



BKT22X30X6S

21-1/2"

30"

6"

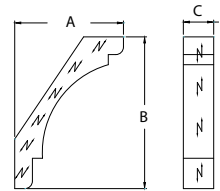







Decorative Millwork

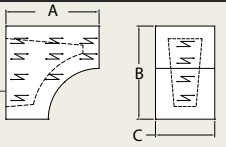

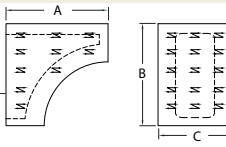
Wood-Grained Corbels

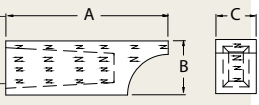
COVE

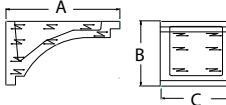









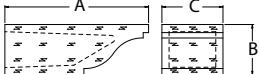

	Part Number	Projection (A)	Height (B)	Overall Width (C)	
	COR5X5X3S	5-1/2"	5-1/2"	3-1/2"	
	COR5X5S	5-1/2"	5-1/2"	5-1/2"	
	COR8X8X6S	8"	8"	6"	
	COR11X11X5S	11"	11"	5"	
	CORCV18X6X6S	18"	5-1/4"	5-1/4"	
	CORCV18X8X4S	18"	7-1/4"	3-1/4"	
	CORCV18X8X6S	18"	7-1/4"	5-1/4"	
	CORCV18X12X6S	18"	11-1/4"	5-1/4"	
	COR24X8X6S	24"	8"	6"	
	COR7X13X7S	13"	7-1/4"	7-1/2"	

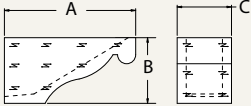

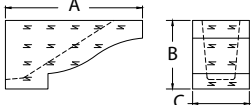
Note: All products have an open cavity.

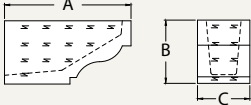

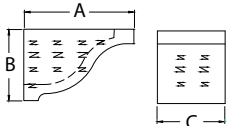

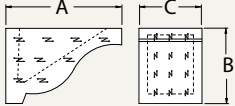

Wood-Grained Corbels

SCROLL

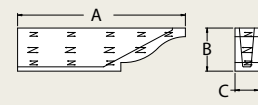
	Part Number	Projection (A)	Height (B)	Overall Width (C)	
	COROG24X6S	24"	5-7/8"	5-5/8"	
	COROG20X7S	20"	7"	8-1/2"	
	COROG15X7S	14-1/2"	7-1/4"	6"	
	COROGA15X7S	14-1/2"	7-1/4"	6"	
	COROGRD15X7S	14-1/2"	7-1/4"	6"	
	COR7X11S	11-3/8"	7-3/8"	7"	
	COROG8X12S	11-3/8"	7-3/8"	7-3/8"	

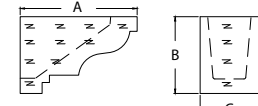
Wood-Grained Corbels

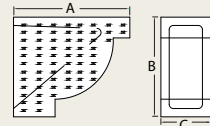
SCROLL

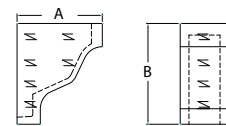





	Part Number	Projection (A)	Height (B)	Overall Width (C)	
	COR39X10X5.5S	39-1/4"	9-1/8"	5-1/2"	
	COR16X10X8S	16"	10-1/2"	8"	
	COR14X12X6S	14"	12"	6"	
	COR11X13X6S	11"	13"	6"	

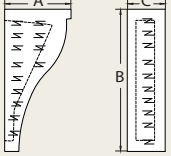

Note: All products have an open cavity.

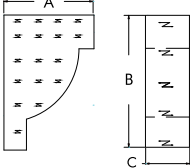
Wood-Grained Corbels

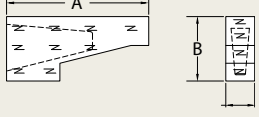
ASSORTED

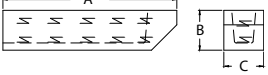



	Part Number	Projection (A)	Height (B)	Overall Width (C)	
	COR7X15X4S ¹	7"	15"	4"	
	COR12X18X6S	12"	18"	6"	
	COR16X7X3S ¹	16"	7-1/4"	3-1/4"	
	COR24X5X5S ¹	24"	5-1/2"	5-1/2"	

Decorative Millwork

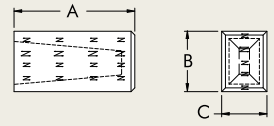

Wood-Grained Corbels

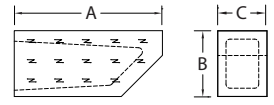
ASSORTED

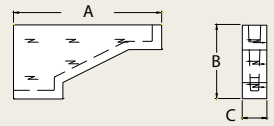
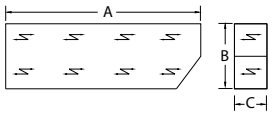
	Part Number	Projection (A)	Height (B)	Overall Width (C)	
	COR16X8S ¹	16"	8"	6"	
	COR18X8X6S ¹	18"	8"	6"	
	COR18X9X3S ¹	18"	9"	3"	
	COR24X8X4S ¹	24"	8"	4"	



¹Product has an open cavity.

Rafter Tails

ROUGH SAWN WOOD GRAIN



Straight Profile (ST)	Cove Profile (CV)	Slant Profile (SL)	Bullnose Profile (BL)	Scroll Profile (SC)
BMRTST4X6X12RS-4PK	—	BMRTSL4X6X12RS-4PK	BMRTBL4X6X12RS-4PK	BMRTSC4X6X12RS-4PK
BMRTST4X6X18RS-4PK	BMRTCV4X6X18RS-4PK	BMRTSL4X6X18RS-4PK	BMRTBL4X6X18RS-4PK	BMRTSC4X6X18RS-4PK
BMRTST4X6X24RS-4PK	BMRTCV4X6X24RS-4PK	BMRTSL4X6X24RS-4PK	BMRTBL4X6X24RS-4PK	BMRTSC4X6X24RS-4PK
BMRTST4X6X30RS-4PK ¹	BMRTCV4X6X30RS-4PK ¹	BMRTSL4X6X30RS-4PK ¹	BMRTBL4X6X30RS-4PK ¹	BMRTSC4X6X30RS-4PK ¹
BMRTST4X6X36RS-4PK ¹	BMRTCV4X6X36RS-4PK ¹	BMRTSL4X6X36RS-4PK ¹	BMRTBL4X6X36RS-4PK ¹	BMRTSC4X6X36RS-4PK ¹
BMRTST4X6X42RS-4PK ¹	BMRTCV4X6X42RS-4PK ¹	BMRTSL4X6X42RS-4PK ¹	BMRTBL4X6X42RS-4PK ¹	BMRTSC4X6X42RS-4PK ¹
BMRTST4X8X18RS-4PK	BMRTCV4X8X18RS-4PK	BMRTSL4X8X18RS-4PK	BMRTBL4X8X18RS-4PK	BMRTSC4X8X18RS-4PK
BMRTST4X8X24RS-4PK	BMRTCV4X8X24RS-4PK	BMRTSL4X8X24RS-4PK	BMRTBL4X8X24RS-4PK	BMRTSC4X8X24RS-4PK
BMRTST4X8X30RS-4PK ¹	BMRTCV4X8X30RS-4PK ¹	BMRTSL4X8X30RS-4PK ¹	BMRTBL4X8X30RS-4PK ¹	—
BMRTST4X8X36RS-4PK ¹	BMRTCV4X8X36RS-4PK ¹	BMRTSL4X8X36RS-4PK ¹	BMRTBL4X8X36RS-4PK ¹	BMRTSC4X8X36RS-4PK ¹
BMRTST4X8X42RS-4PK ¹	BMRTCV4X8X42RS-4PK ¹	BMRTSL4X8X42RS-4PK ¹	BMRTBL4X8X42RS-4PK ¹	BMRTSC4X8X42RS-4PK ¹

Decorative Millwork

HOW TO ORDER

- Select profile design.
 - Select size.
 - Optional: Select pitch angle needed.
 - Select pack quantity.¹
- Rafter tails are available in five profile designs: Straight, Cove, Slant, Bullnose and Scroll.
 - Available in heights measuring 5-1/2" (6 nominal) and 7-1/2" (8 nominal).
 - Six projections: 12", 18", 24", 30", 36", 42".
 - Optional back cut pitch angles: 4 / 12, 6 / 12, 8 / 12, 10 / 12, 2 / 12.
 - Quantities: 4 Pack, 10 Pack.

PART NUMBER LOGIC

BMRTSC4X6X24RSP8-4PK

[Profile]
ST = Straight
CV = Cove
SL = Slant
BL = Bullnose
SC = Scroll

[Width]
4 = 4" (3-1/2" Actual)

[Projection]
12 = 12"
18 = 8"
24 = 24"
30 = 30"
36 = 36"
42 = 42"

[Height]
6 = 6" (5-1/2" Actual)
8 = 8" (7-1/2" Actual)

[Pack Quantity]
4PK = 4 Pack
10PK = 10 Pack

[Optional Pitch]
P4 = 4 / 12
P6 = 6 / 12
P8 = 8 / 12
P10 = 10 / 12
P12 = 12 / 12
(Blank) = No Pitch

4x6x24 Scroll Profile with Pitch



4x8x24 Scroll Profile without Pitch

¹Rafter tails more than 24" long are only available in pack quantities of four.
Note: All products have an open cavity.

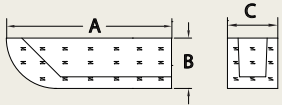

Rafter Tails

STANDARD WOOD GRAIN

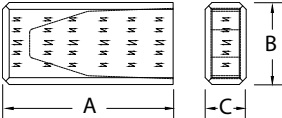

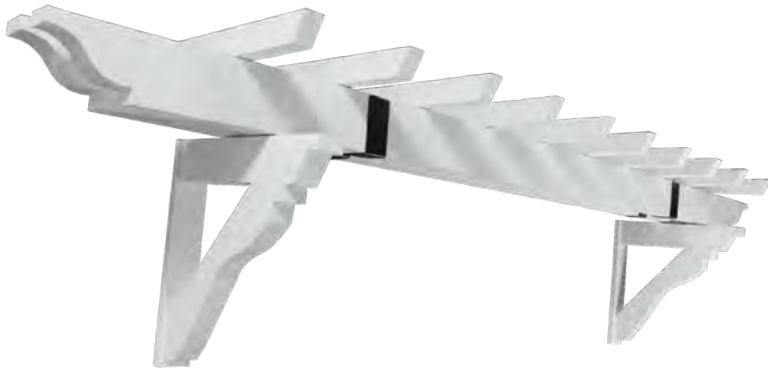

	Part Number	Length (A)	Height (B)	Overall Width (C)	
	BMRTS6X4X24S	24"	5-1/4"	3-1/4"	
	BMRTS8X4X24S	24"	7-1/4"	3-1/4"	
	BMCRT25X12X6S	25"	12"	6"	

Smooth Trellis System



Trellis Kit Part Number & Contents	Overall Width (Installed)	Overall Height (Installed)	Projection (Installed)
TRLS19003 Fits 16'-18' Garage Doors (2) BKT32X31X5, Outlooker (4) BMD4X8X144, 12' Beam (18) FLTBA36X3X3, Lattice (1) TRLS18989, Hardware Kit	21' 9" Over 16' Door 23' 9" Over 18' Door	41-7/8"	36"

TRLS19004 Fits 8'-9' Garage Doors (2) BKT32X31X5, Outlooker (2) BMD4X8X48, 4' Beam (2) BMD4X8X144, 12' Beam (10) FLTBA36X3X3, Lattice (1) TRLS18994, Hardware Kit	13' 9" Over 8' Door 14' 9" Over 9' Door	41-7/8"	36"
--	--	---------	-----

Individual Trellis Components	Part Number	Projection	Height	Overall Width
	BKT32X31X5 Outlooker	32-1/2"	30-5/8"	5-1/4"
	BMD4X8X481 Beam	4-1/4"	7-3/4"	48"
Scrolled profile on one end only.	BMD4X8X1441 Beam	4-1/2"	7-3/4"	144"
	FLTBA36X3X31 Lattice	36"	3-1/2"	2-3/4"
Angled on one end only.				
	TRLS18989 Hardware Kit for TRLS19003	Kit Contains: (3) Angle Bracket (3) U Bracket (1) HDW Pack ² (1) Installation Guide	—	—
	TRLS18994 Hardware Kit for TRLS19004	Kit Contains: (2) Angle Bracket (2) U Bracket (1) HDW Pack ² (1) Installation Guide	—	—

¹This product is not finished on all sides.

²HDW pack contains: lock washers, hex nuts and bolts.

Note: For installation instructions, visit fypon.com.





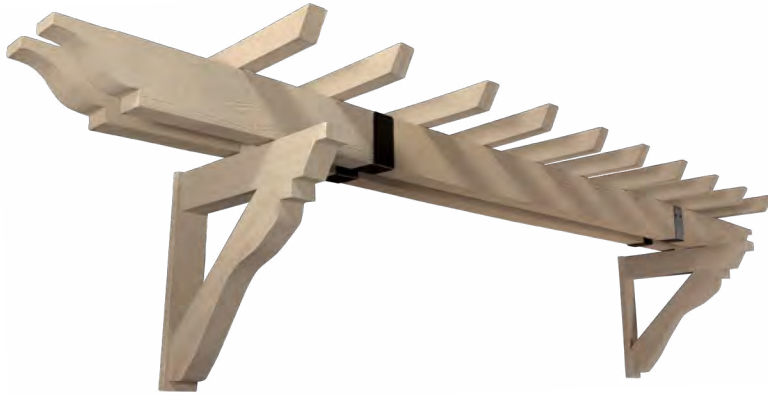

Wood-Grained Trellis System



Trellis Kit Part Number & Contents	Overall Width (Installed)	Overall Height (Installed)	Projection (Installed)
TRLS18987 Fits 16'-18' Garage Doors (2) BKT32X31X5S, Outlooker (4) BMD4X8X144S, 12' Beam (18) FLTBA36X3X3S, Lattice (1) TRLS18989, Hardware Kit	21' 9" Over 16' Door 23' 9" Over 18' Door	41-7/8"	36"

TRLS18988 Fits 8'-9' Garage Doors (2) BKT32X31X5S, Outlooker (2) BMD4X8X48S, 4' Beam (2) BMD4X8X144S, 12' Beam (10) FLTBA36X3X3S, Lattice (1) TRLS18994, Hardware Kit	13' 9" Over 8' Door 14' 9" Over 9' Door	41-7/8"	36"
--	--	---------	-----

Individual Trellis Components	Part Number	Projection	Height	Overall Width
	BKT32X31X5S Outlooker	32-1/2"	30-5/8"	5-1/4"
	BMD4X8X48S ¹ Beam	4-1/4"	7-3/4"	48"
	BMD4X8X144S ¹ Beam	4-1/4"	7-3/4"	144"
	FLTBA36X3X3S ¹ Lattice	36"	3-1/2"	2-3/4"
	TRLS18989 Hardware Kit for TRLS18987	Kit Contains: (3) Angle Bracket (3) U Bracket (1) HDW Pack ² (1) Installation Guide		
	TRLS18994 Hardware Kit for TRLS18988	Kit Contains: (2) Angle Bracket (2) U Bracket (1) HDW Pack ² (1) Installation Guide		

¹This product is not finished on all sides.

²HDW pack contains: lock washers, hex nuts and bolts.

Note: For installation instructions, visit fypon.com.



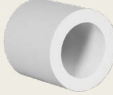
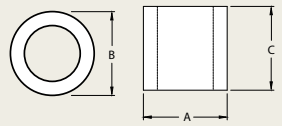

Tile Vents

	Part Number	Width (A)	Height (B)	Projection (C)	
	CN6X6	6"	6"	6"	

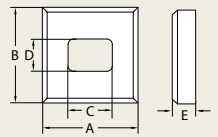

Fixture Mounts

	Part Number	Width (A)	Height (B)	Inside Width (C)	Inside Height (D)	Projection (E)	
	FMS8X8X2 Square	8"	8"	3-3/4"	2-3/4"	2"	



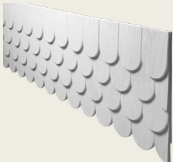
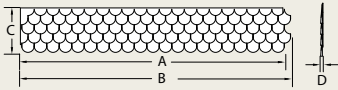

Fishscale Panel

ROUND SCALES

	Part Number	Width (A)	Height (B)	Inside Width (C)	Inside Height (D)	
	FSR103X17	98-5/8"	101-5/8"	16-1/4"	3/4"	



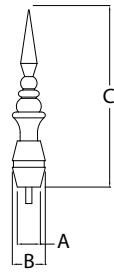



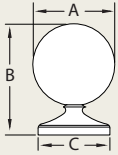

Tile Spires

	Part Number	Base Diameter (A)	Diameter (B)	Height (C)	Anchoring Pipe	
	S4X21	3-1/2"	7"	21-1/4"	3/4" x 6"	
	S6X32	4-1/4"	6"	32-1/4"	1-1/8" x 3"	

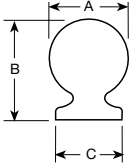
Decorative Millwork

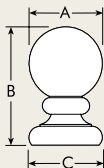

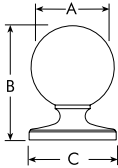
Full-Round Finial

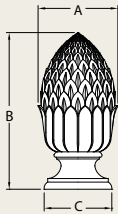
	Part Number	Ball Diameter (A)	Height (B)	Base Diameter (C)	
	B4X6	4"	5-1/2"	3-1/2"	
	B5X7	5-1/4"	6-3/4"	4-3/8"	
	B6X8	5-7/8"	7-3/4"	5-7/8"	
	B6X9	7"	9"	5-7/8"	
	B8X10	8"	10"	8-1/4"	
	B10X13	10"	12-7/8"	8-1/2"	
	B12X16	12"	16"	12"	
	B3X5 Post Ball	3-1/4"	5-1/4"	3-1/4"	
	B7X9 Decorative Ball	6-1/4"	8-1/2"	6-1/2"	
	PHFR5X11 Pineapple	5-5/8"	11"	4-3/4"	
	PHFR6X14 Pineapple	7-1/8"	14"	6-1/8"	







Historic style for any home.

Fypon® offers a diverse assortment of decorative, non-venting and functional, venting louvers to complement most architectural home styles. Decorative louvers feature a solid, one-piece design that does not allow air to pass through. Functional louvers are designed to provide additional ventilation, with angled slats and screening to help protect interiors from the elements.

LOUVERS

- 214 Cathedral Louver
- 215 Eyebrow Louver
- 215 Peaked Louver
- 216 Vertical Louver
- 219 Horizontal Louver
- 220 Half-Round Louver
- 222 Round Louver
- 225 Oval Louver
- 226 Triangle Louver
- 227 Two-Piece Triangle Louver
- 227 Diamond Louver
- 227 Octagon Louver

Louvers

HOW TO USE THIS SECTION

The products in this section of the catalog are organized by moulding type. You can find a variety of products to match the aesthetics of almost any application conveniently grouped together. Where applicable, groups of mouldings are further sorted by height, from smallest to largest.

HOW TO ORDER FUNCTIONAL LOUVERS

Accessories are available to help make moulding installations quick and easy. Rosettes can be used between moulding lengths to eliminate the need for patching to create smooth seams. All rosettes are unattached and must be ordered separately.

HOW TO ORDER LOUVER ACCESSORIES

Keystones and trim are available attached to standard products as fabricated items. Keystones and trim can also be ordered as unattached accessories by listing the matching part number as a separate line item on your order.

LOUVER KEYSTONE APPLICATIONS

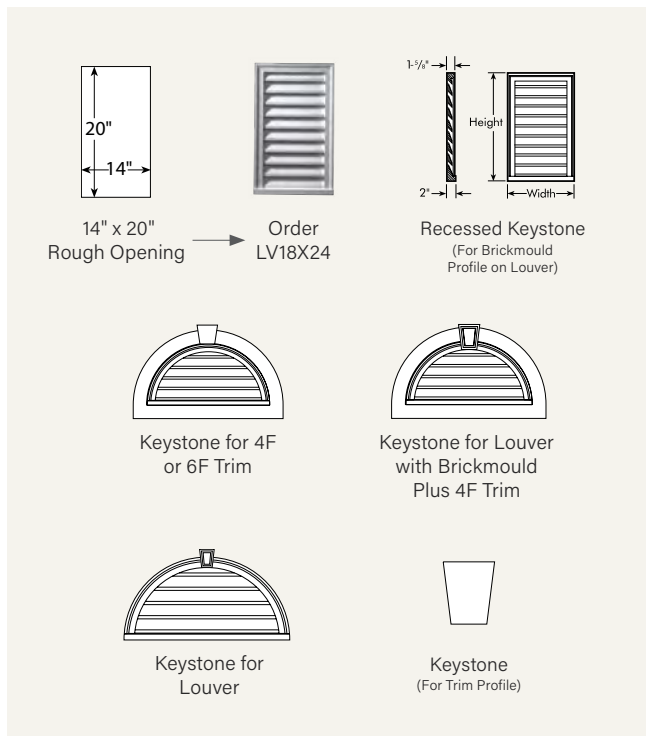

Note: Always consult the local building code authority to determine suitability of products to meet specific project requirements.



Cathedral Louver

BRICKMOULD STYLE



Cathedral Louver

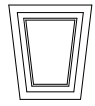

4F Flat Trim

Keystone
KWM180M

Louver Decorative Part Number	Louver Functional Part Number	Width	Height	Vent Area	Louver Trim
CLV12X24	FCLV12X24	12"	24"	10 Sq. In.	—
CLV14X22	FCLV14X22	14"	22"	14 Sq. In.	—
CLV16X36	FCLV16X36	16"	36"	21 Sq. In.	—
CLV18X24	FCLV18X24	18"	24"	20 Sq. In.	—
CLV18X30	FCLV18X30	18"	30"	36 Sq. In.	CLV18X30X4F
CLV22X31	FCLV22X31	22"	31-1/2"	41 Sq. In.	CLV22X31X4F
CLV24X48	FCLV24X48	24"	48"	73 Sq. In.	—
CLV28X43	FCLV28X43	28"	43"	76 Sq. In.	—
CLV36X48	FCLV36X48	36"	48"	102 Sq. In.	—

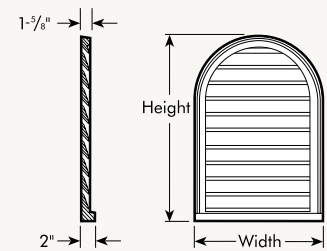

Flat Trim Part Number	Inside Width	Inside Height	Trim Width	Projection
CLV18X30X4F	18-1/4"	30-1/4"	3-1/2"	1"
CLV22X31X4F	22-1/4"	31-1/4"	3-1/2"	1"

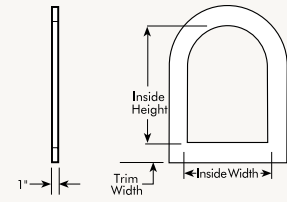



Cathedral Louver

BRICKMOULD STYLE

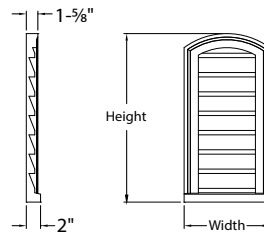

Decorative Part Number	Functional Part Number	Width	Overall Height	Shoulder Height	Radius	Vent Area
EBLV12X24	FEBLV12X24	12"	24"	22"	10"	13 Sq. In.
EBLV18X30	FEBLV18X30	18"	30"	27-1/4"	16"	30 Sq. In.
EBLV22X32	FEBLV22X32	22"	32"	28-1/2"	20"	38 Sq. In.

Peaked Louver

BRICKMOULD STYLE

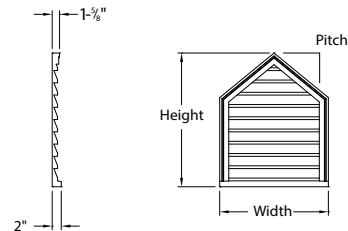

Decorative Part Number	Functional Part Number	Width	Height	Pitch	Vent Area
PLV18X24-8	FPLV18X24-8	18"	24"	8 / 12	20 Sq. In.
PLV18X36-10	FPLV18X36-10	18"	36"	10 / 12	35 Sq. In.
PLV24X30-10	—	24"	30"	10 / 12	37 Sq. In.
PLV24X36-10	—	24"	36"	10 / 12	48 Sq. In.
PLV24X36-12	FPLV24X36-12	24"	36"	12 / 12	47 Sq. In.

Vertical Louver

BRICKMOULD STYLE

 See the product through your mobile device at fypon.com/AR

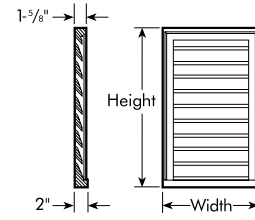

Decorative Part Number	Functional Part Number	Width	Height	Vent Area
LV8X15	FLV8X15	8"	15"	3 Sq. In.
LV8X24	FLV8X24	8"	24"	7 Sq. In.
LV8X30	FLV8X30	8"	30"	9 Sq. In.
LV12X18	FLV12X18	12"	18"	10 Sq. In.
LV12X24	FLV12X24	12"	24"	16 Sq. In.
LV12X30	FLV12X30	12"	30"	18 Sq. In.
LV12X36	FLV12X36	12"	36"	22 Sq. In.





Vertical Louver

BRICKMOULD STYLE

Decorative Part Number	Functional Part Number	Width	Height	Vent Area
LV12X40	FLV12X40	12"	40"	24 Sq. In.
LV14X27	FLV14X27	14"	27"	20 Sq. In.
LV14X30	FLV14X30	14"	30"	22 Sq. In.
LV14X32	FLV14X32	14"	32"	27 Sq. In.
LV16X24	FLV16X24	16"	24"	21 Sq. In.
LV16X36	FLV16X36	16"	36"	32 Sq. In.
LV18X24	FLV18X24	18"	24"	24 Sq. In.
LV18X30	FLV18X30	18"	30"	31 Sq. In.
LV18X36	FLV18X36	18"	36"	38 Sq. In.
LV18X42	FLV18X42	18"	42"	45 Sq. In.
LV20X28	FLV20X28	19-1/2"	27-1/2"	31 Sq. In.
LV24X24	FLV24X24	24"	24"	35 Sq. In.
LV24X30	FLV24X30	24"	30"	45 Sq. In.
LV24X36	FLV24X36	24"	36"	54 Sq. In.
LV24X48	FLV24X48	24"	48"	74 Sq. In.
LV30X42	FLV30X42	30"	42"	84 Sq. In.



Vertical Louver

BRICKMOULD STYLE WITH NO SILL

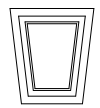
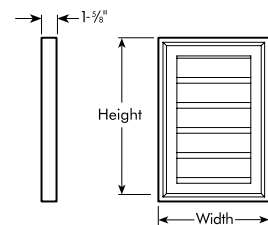

Keystone
KWM180M

Decorative Part Number	Functional Part Number	Width	Height	Vent Area
LVNS18X24	FLVNS18X24	18"	24"	21 Sq. In.

Vertical Louver

WITH 4F FLAT TRIM & 6" CROSSHEAD

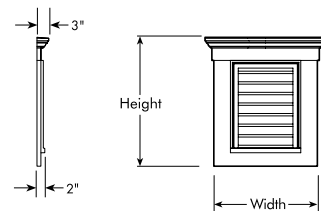

Decorative Part Number	Functional Part Number	Width	Overall Width	Height	Vent Area
LV18X24-4F6WCH	FLV18X24-4F6WCH	26-1/2"	31"	33-1/2"	24 Sq. In.

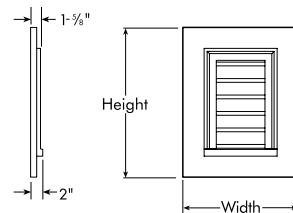

Vertical Louver

WITH FLAT TRIM ATTACHED

Decorative Part Number	Overall Width	Overall Height	Trim Width	Trim Projection
LV18X30-4F	25"	37"	3-1/2"	1"

Horizontal Louver

BRICKMOULD STYLE

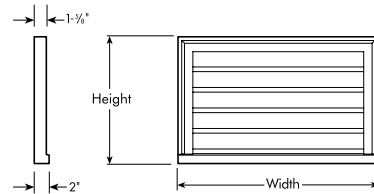
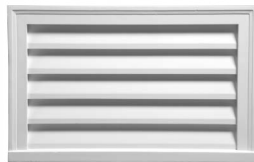

Decorative Part Number	Functional Part Number	Width	Height	Vent Area
LV27X17	FLV27X17	27"	17"	23 Sq. In.
LV32X16	FLV32X16	32"	16"	28 Sq. In.

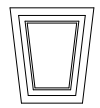
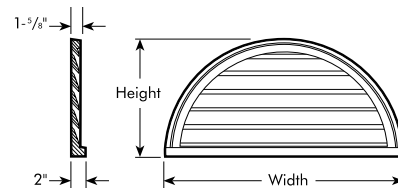
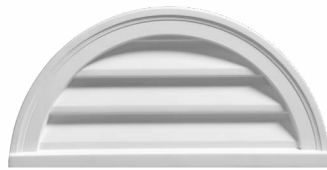
Keystone
KWM180M

Half-Round Louver

BRICKMOULD STYLE

Decorative Part Number	Functional Part Number	Width	Height	Vent Area
HRLV24X12	FHRLV24X12	24"	12"	9 Sq. In.
HRLV28X14	FHRLV28X14	28"	14"	13 Sq. In.
HRLV32X16	FHRLV32X16	32"	16"	21 Sq. In.
HRLV36X18	FHRLV36X18	36"	18"	28 Sq. In.
HRLV40X20	FHRLV40X20	40"	20"	36 Sq. In.
HRLV42X21	FHRLV42X21	42"	21"	40 Sq. In.
HRLV48X24	FHRLV48X24	48"	24"	55 Sq. In.
HRLV60X30	FHRLV60X30	60"	30"	85 Sq. In.
HRLV72X36	—	72"	36"	122 Sq. In.

Vertical Louver

BRICKMOULD STYLE
WITH FLAT TRIM ATTACHED

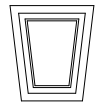
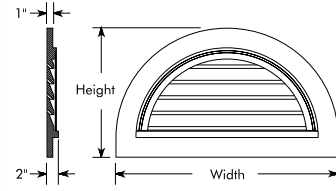

Keystone
KWM180M

Decorative Part Number	Functional Part Number	Overall Width	Overall Height	Trim Width	Trim Projection	Vent Area
Trim Projection HRLV36X18-4F	—	43"	25"	3-1/2"	1"	29 Sq. In.
HRLV36X18-6F	—	47"	29"	5-1/2"	1"	29 Sq. In.

Vertical Louver

BRICKMOULD STYLE
WITH DECORATIVE TRIM & KEYSTONE

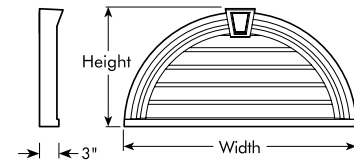
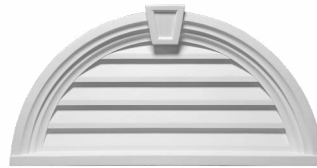

Decorative Part Number	Functional Part Number	Overall Width	Overall Height	Projection	Vent Area
HRLV36X18MTK	FHRLV36X18MTK	36"	18-1/2"	3"	24 Sq. In.

Vertical Louver

BRICKMOULD STYLE
WITH DECORATIVE TRIM & KEYSTONE

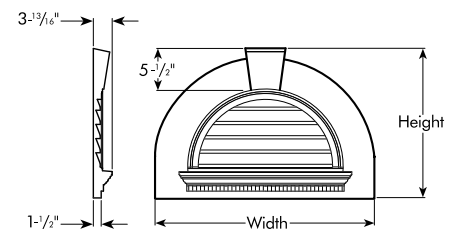

Decorative Part Number	Functional Part Number	Overall Width	Overall Height	Overall Projection	Trim Projection	Vent Area
HRLV29-6FKWD	—	41-5/8"	29"	3-3/4"	1-1/2"	29 Sq. In.

Round Louver

BRICKMOULD STYLE

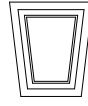
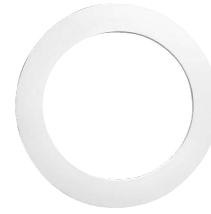

Round Louver

Keystone
KWM180M¹

4F Flat Trim

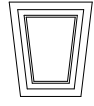
Keystone
K4TF | KP4TF

Decorative Part Number	Functional Part Number	Diameter	Vent Area	Louver Trim
RLV12 ²	FRLV12 ²	12"	7 Sq. In.	—
RLV16	FRLV16	16"	9 Sq. In.	—
RLV18	FRLV18	18"	12 Sq. In.	RLV18X4F
RLV22	FRLV22	22"	22 Sq. In.	—
RLV24	FRLV24	24"	27 Sq. In.	RLV24X4F
RLV28	FRLV28	28"	38 Sq. In.	RLV28X4F
RLV30	FRLV30	30"	46 Sq. In.	—
RLV36	FRLV36	36"	70 Sq. In.	CIR36X4F
RLV42	FRLV42	42"	99 Sq. In.	—
RLV48	FRLV48	48"	107 Sq. In.	—

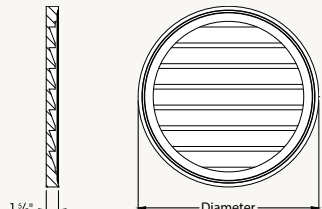

Trim Part Number	Trim Width	Projection	Inside Diameter
RLV18X4F	3-1/2"	1"	18-1/4"
RLV24X4F	3-1/2"	1"	24-1/4"
RLV28X4F	3-1/2"	1"	28-1/4"

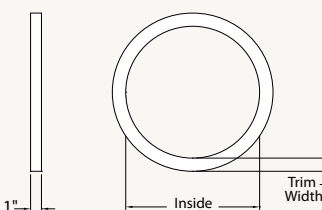

Round Louver

WITH FLAT TRIM

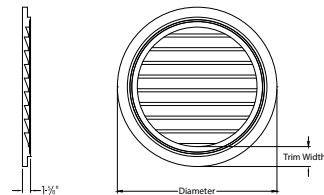

Decorative Part Number	Functional Part Number	Diameter	Trim Width	Trim Thickness	Vent Area
RLV32-2F	FRLV32-2F	32"	2"	1-5/8"	38 Sq. In.

¹Product must be field trimmed to match RLV12 and FRLV12.
²1-5/16" projection on RLV12 and FRLV12.



Round Louver

WITH FLAT TRIM & FLAT KEYSTONES

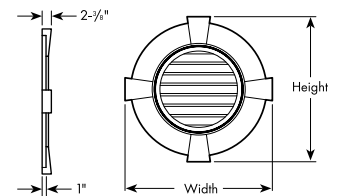
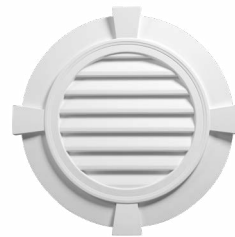

Decorative Part Number	Functional Part Number	Diameter	Overall Width / Height	Trim Width	Trim Thickness	Vent Area
RLV24-4FTK	FRLV24-4FTK	31"	32-7/8"	3-1/2"	1"	26 Sq. In.
RLV24-6TK	FRLV24-6TK	35"	38"	5-1/2"	1"	26 Sq. In.
RLV30-6TK	FRLV30-6TK	41"	44"	5-1/2"	1"	47 Sq. In.

Round Louver

WITH DECORATIVE TRIM & KEYSTONES

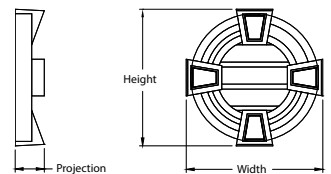
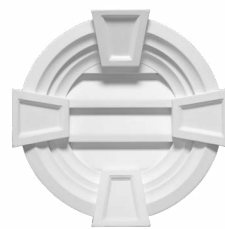

Decorative Part Number	Functional Part Number	Diameter	Overall Width / Height	Projection	Vent Area
RLV16MTK	FRLV16MTK	16"	17-1/8"	3-5/8"	4 Sq. In.
RLV18MTK	FRLV18MTK	18"	19-1/8"	3-5/8"	4 Sq. In.
RLV24MTK	FRLV24MTK	23-7/8"	25"	3-5/8"	19 Sq. In.
RLV30MTK	FRLV30MTK	30"	31-1/8"	3-5/8"	35 Sq. In.
RLV32MTK	FRLV32MTK	31-5/8"	33-1/4"	4-1/8"	26 Sq. In.
RLV40MTK	—	40"	41-1/4"	3-5/8"	76 Sq. In.

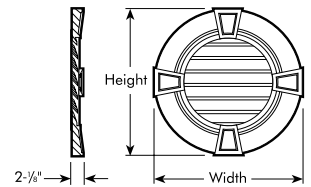
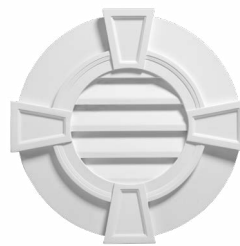

Round Louver

WITH FLAT TRIM & KEYSTONES

Decorative Part Number	Functional Part Number	Diameter	Width	Trim Width	Trim Thickness	Vent Area
RLV24TK	FRLV24TK	22-7/8"	24"	3-1/2"	1"	10 Sq. In.
RLV30TK	—	28-7/8"	30"	3-1/2"	1"	22 Sq. In.
RLV36TK	FRLV36TK	35"	36"	3-1/2"	1"	38 Sq. In.

Oval Louver

BRICKMOULD STYLE

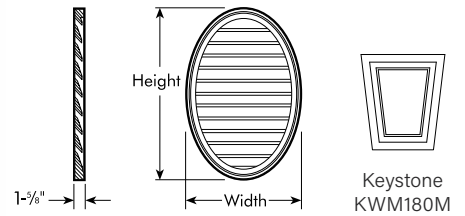

Decorative Part Number	Functional Part Number	Width	Height	Vent Area
OVLV18X24V	FOVLV18X24V	18"	24"	18 Sq. In.
OVLV25X37V	FOVLV25X37V	24-1/2"	37"	24 Sq. In.

Oval Louver – Vertical

WITH DECORATIVE TRIM & KEYSTONES

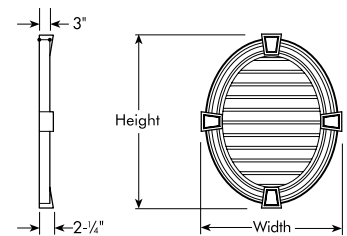

Decorative Part Number	Functional Part Number	Overall Width	Overall Height	Projection	Vent Area
OVL28X35K215V	FOVL28X35K215V	30"	37-1/2"	3"	39 Sq. In.

Oval Louver – Vertical

WITH FLAT TRIM & KEYSTONES

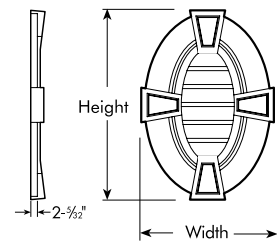

Decorative Part Number	Functional Part Number	Overall Width	Overall Height	Projection	Vent Area
OVLV20X29VTK	—	20"	29"	2-1/8"	39 Sq. In.

Oval Louver – Horizontal

WITH DECORATIVE TRIM & KEYSTONES

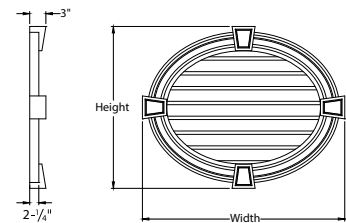

Decorative Part Number	Functional Part Number	Overall Width	Overall Height	Projection	Vent Area
OVL35X28K215	FOVL35X28K215	37-1/2"	30"	3"	41 Sq. In.



Triangle Louver

BRICKMOULD STYLE

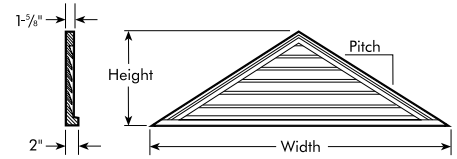
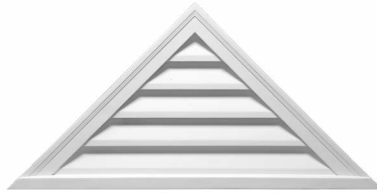

Decorative Part Number	Functional Part Number	Width	Height	Pitch	Vent Area
TRLV36X18	FTRLV36X18	36"	18"	12 / 12	10 Sq. In.
TRLV42X21	FTRLV42X21	42"	21"	12 / 12	18 Sq. In.
TRLV48X12	FTRLV48X12	48"	12"	6 / 12	12 Sq. In.
TRLV48X18	FTRLV48X18	48"	18"	9 / 12	19 Sq. In.
TRLV48X22	FTRLV48X22	48"	22"	11 / 12	27 Sq. In.
TRLV48X24	FTRLV48X24	48"	24"	12 / 12	31 Sq. In.
TRLV60X18	FTRLV60X18	60"	17-1/2"	7 / 12	27 Sq. In.
TRLV60X23	FTRLV60X23	60"	22-1/2"	9 / 12	30 Sq. In.
TRLV60X25	FTRLV60X25	60"	25"	10 / 12	33 Sq. In.
TRLV60X30	FTRLV60X30	60"	30"	12 / 12	51 Sq. In.
TRLV64X27	FTRLV64X27	64"	26-1/2"	10 / 12	34 Sq. In.
TRLV64X32	FTRLV64X32	64"	32"	12 / 12	60 Sq. In.
TRLV66X22	FTRLV66X22	66"	22"	8 / 12	35 Sq. In.
TRLV72X36	FTRLV72X36	72"	36"	12 / 12	79 Sq. In.
TRLV76X19	FTRLV76X19	76"	19"	6 / 12	30 Sq. In.
TRLV84X18	FTRLV84X18	84"	17-1/2"	5 / 12	34 Sq. In.
TRLV84X21	FTRLV84X21	84"	21"	6 / 12	44 Sq. In.
TRLV88X22	FTRLV88X22	88"	22"	6 / 12	38 Sq. In.

Two-Piece Triangle Louver

BRICKMOULD STYLE

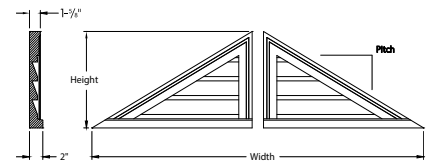

Decorative Part Number	Functional Part Number	Width	Height	Pitch	Vent Area
TRLVLR60X25	FTRLVLR60X25	60"	25"	10 / 12	35 Sq. In.
TRLVLR60X30	FTRLVLR60X30	60"	30"	12 / 12	46 Sq. In.
TRLVLR108X27	—	108"	27"	6 / 12	78 Sq. In.
TRLVLR115X35	FTRLVLR115X35	115"	34-1/2"	7-1/4 / 12	133 Sq. In.
TRLVLR120X30	FTRLVLR120X30	120"	30"	6 / 12	104 Sq. In.

Diamond Louver

BRICKMOULD STYLE

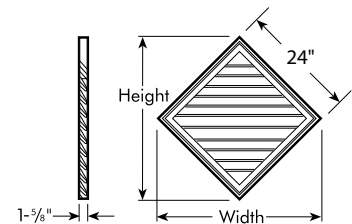

Decorative Part Number	Functional Part Number	Width	Height	Vent Area
DLV24X24	FDLV24X24	34"	34"	32 Sq. In.

Octagon Louver

BRICKMOULD STYLE

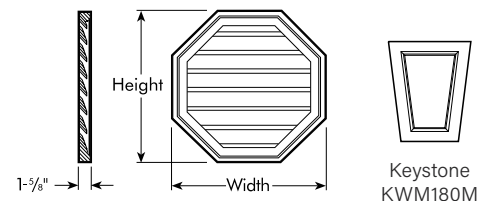

Decorative Part Number	Functional Part Number	Width	Height	Vent Area
OLV18	FOLV18	18"	18"	14 Sq. In.
OLV22	FOLV22	22"	22"	23 Sq. In.
OLV24	FOLV24	24"	24"	29 Sq. In.
OLV28	FOLV28	28"	28"	41 Sq. In.





Coverage with character.

Once you've met the structural requirements of your project, Fypon® column wraps can be used to add an elegant finishing touch. Designed for easy installation around an existing structural support, column wraps are perfect for adding character to a new job or covering an outdated design.

COLUMN WRAPS

- 230 Installation Kit
- 232 ProSelect PVC Smooth Square Column Wraps
- 233 ProSelect PVC Flat-Pack Square Column Wraps
- 235 PremiumSelect Square Column Wraps
- 236 PremiumSelect Flat-Pack Square Column Wraps
- 238 Square Cap & Base Accessories
- 240 PremiumSelect Tapered Column Wraps
- 242 PremiumSelect Flat-Pack Tapered Column Wraps
- 243 Tapered Cap & Base Accessories
- 245 EverCedar Flat-Pack Square Column Wraps
- 246 EverCedar Flat-Pack Tapered Column Wraps

Column Wraps

HOW TO ORDER COLUMN WRAPS

Fypon® column wraps are non-structural and designed to wrap around an existing treated wood post or other structural support. Square and tapered styles are available in a variety of heights and are trimmable from the bottom of the shaft up to 3". Flat-panel column wraps can be trimmed to any height.

PremiumSelect column wraps come in a complete kit that includes shaft, cap, base, installation cleat, hardware, tube of adhesive and installation materials. Installation kits for ProSelect column wraps are sold separately.

Flat-pack column wraps ship unassembled for better handling and utilization of less storage space. Choose from square and tapered styles in smooth PVC or wood-grained polyurethane.

HOW TO ORDER ACCESSORIES

Square column wraps come semi-assembled and include a Traditional cap and base, and tapered column wraps come semi-assembled and include a Craftsman cap and base. Six additional cap and base styles are available and can be ordered separately. Caps and bases ship in four separate pieces with pre-mitered corners.

SPECIAL ORDER PRODUCTS

PremiumSelect products shown in the catalog are available in additional sizes. Product may be modified to minimum 6" width to a 24" maximum width. The height may also be modified with a minimum height of 48" to a maximum of 144" height (maximum 108" for tapered).

FLEXIBLE POSITIONING COLUMN WRAPS

The design features installation cleats on the interior or exterior of the shaft providing ample room around the support post. This allows for positioning adjustments to align several columns in a row or to allow for positioning close to the porch edge. Also, because the column wrap does not come in contact with the structural post, the integrity of the wrap is not dependent on the support. Before you order, you'll want to measure to make sure you have enough clear distance from the support post to the edge of the porch. The needed space is dependent on the style of column. You will need more space for tapered columns than square due to the larger base.

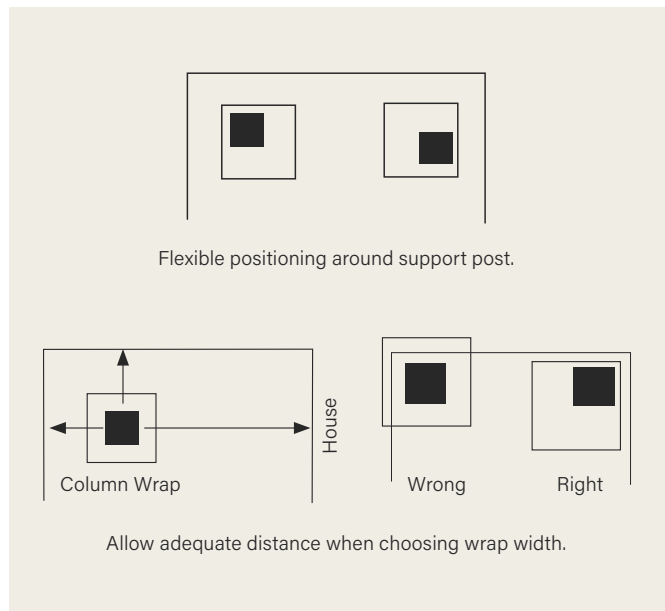

INSTALLATION KIT

	Description	Part Number
	Installation Kit includes adhesive and screw pack.	CWINSTALLKIT



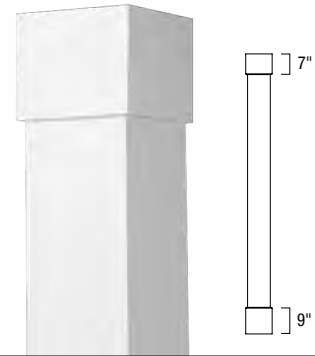

ProSelect

SQUARE COLUMN WRAPS

SEMI-ASSEMBLED PVC FLAT PANEL WITH PLAIN CAP & BASE

Shaft Width	Height	Flat Panel (FT)
6" (5" Actual) 4" Actual Inside Width	6' (72")	CWPR6X72SFT
	8' (96")	CWPR6X96SFT
	9' (108")	CWPR6X108SFT
	10' (120")	CWPR6X120SFT
	12' (144")	CWPR6X144SFT
8" (7-3/4" Actual) 4-7/8" Actual Inside Width	6' (72")	CWPR8X72SFT
	8' (96")	CWPR8X96SFT
	9' (108")	CWPR8X108SFT
	10' (120")	CWPR8X120SFT
	12' (144")	CWPR8X144SFT
10" (9-3/4" Actual) 6-7/8" Actual Inside Width	6' (72")	CWPR10X72SFT
	8' (96")	CWPR10X96SFT
	9' (108")	CWPR10X108SFT
	10' (120")	CWPR10X120SFT
	12' (144")	CWPR10X144SFT
12" (11-3/4" Actual) 8-7/8" Actual Inside Width	6' (72")	CWPR12X72SFT
	8' (96")	CWPR12X96SFT
	9' (108")	CWPR12X108SFT
	10' (120")	CWPR12X120SFT
	12' (144")	CWPR12X144SFT

ProSelect Flat-Pack

SQUARE COLUMN WRAPS

UNASSEMBLED PVC SHAFT

FEATURES:

- ProSelect square column shaft features a flat-panel style.
- Accessories are sold separately, allowing you to create a custom look. See page 238 for additional options.
- Interior cleat included for installation.
- Installation materials sold separately. See page 230.
- Product ships flat for easy handling and storage.
- Cap and base sold separately.



Shaft Width	Height	Flat Panel (FT)
6" (5-3/4" Actual)	8' (96")	CWPRFLT6X6X96SFT
	9' (108")	CWPRFLT6X6X108SFT
4" Actual Inside Width		





Column Wraps

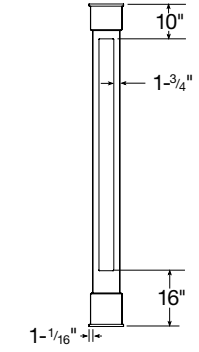
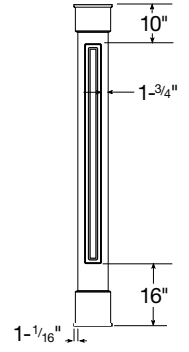
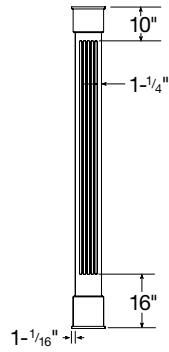
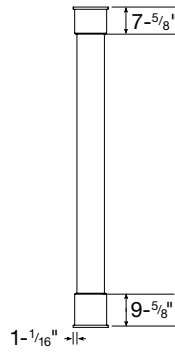

Flutes are 5/8" wide and 1/4" deep. Number and spacing of flutes varies by width of shaft.

Route is 1-11/32" wide by 3/8" deep.

Recess is 1/2" deep and corners are 1/4" rounded.

PremiumSelect

SQUARE COLUMN WRAPS SEMI-ASSEMBLED WITH TRADITIONAL CAP & BASE



Shaft Width	Height	Flat Panel (FT)	Fluted (FL)	Raised Panel (RS)	Recessed Panel (RC)
6" (5-3/4" Actual)	6' (72")	CWPM6X72SFT	—	—	—
	8' (96")	CWPM6X96SFT	—	—	—
	9' (108")	CWPM6X108SFT	—	—	—
	10' (120")	CWPM6X120SFT	—	—	—
	12' (144")	CWPM6X144SFT	—	—	—
4-3/4" Actual Inside Width					
8" (7-3/4" Actual)	6' (72")	CWPM8X72SFT	CWPM8X72SFL	CWPM8X72SRS	CWPM8X72SRC
	8' (96")	CWPM8X96SFT	CWPM8X96SFL	CWPM8X96SRS	CWPM8X96SRC
	9' (108")	CWPM8X108SFT	CWPM8X108SFL	CWPM8X108SRS	CWPM8X108SRC
	10' (120")	CWPM8X120SFT	CWPM8X120SFL	CWPM8X120SRS	CWPM8X120SRC
	12' (144")	CWPM8X144SFT	CWPM8X144SFL	CWPM8X144SRS	CWPM8X144SRC
6-3/4" Actual Inside Width				5-3/4" Actual Inside Width	
10" (9-3/4" Actual)	6' (72")	CWPM10X72SFT	CWPM10X72SFL	CWPM10X72SRS	CWPM10X72SRC
	8' (96")	CWPM10X96SFT	CWPM10X96SFL	CWPM10X96SRS	CWPM10X96SRC
	9' (108")	CWPM10X108SFT	CWPM10X108SFL	CWPM10X108SRS	CWPM10X108SRC
	10' (120")	CWPM10X120SFT	CWPM10X120SFL	CWPM10X120SRS	CWPM10X120SRC
	12' (144")	CWPM10X144SFT	CWPM10X144SFL	CWPM10X144SRS	CWPM10X144SRC
8-3/4" Actual Inside Width				7-3/4" Actual Inside Width	
12" (11-3/4" Actual)	6' (72")	CWPM12X72SFT	CWPM12X72SFL	CWPM12X72SRS	CWPM12X72SRC
	8' (96")	CWPM12X96SFT	CWPM12X96SFL	CWPM12X96SRS	CWPM12X96SRC
	9' (108")	CWPM12X108SFT	CWPM12X108SFL	CWPM12X108SRS	CWPM12X108SRC
	10' (120")	CWPM12X120SFT	CWPM12X120SFL	CWPM12X120SRS	CWPM12X120SRC
	12' (144")	CWPM12X144SFT	CWPM12X144SFL	CWPM12X144SRS	CWPM12X144SRC
10-3/4" Actual Inside Width				9-3/4" Actual Inside Width	

Note: Installation cleats ship with column wrap and are applied on the exterior shaft.

PremiumSelect Flat-Pack

SQUARE COLUMN WRAPS

UNASSEMBLED PVC SHAFT

FEATURES:

- PremiumSelect square column shaft features a flat-panel style.
- Accessories are sold separately, allowing you to create a custom look. See page 238 for additional options.
- Exterior cleat included for easy installation.
- Installation materials sold separately. See page 230.
- Product ships flat for easy handling and storage.
- Cap and base sold separately.









Shaft Width	Height	Flat Panel (FT)
6" (5-3/4" Actual)	8' (96")	CWPMFLT6X6X96SFT
	9' (108")	CWPMFLT6X6X108SFT
	10' (120")	CWPMFLT6X6X120SFT
4-3/4" Actual Inside Width		
8" (7-3/4" Actual)	8' (96")	CWPMFLT8X8X96SFT
	9' (108")	CWPMFLT8X8X108SFT
	10' (120")	CWPMFLT8X8X120SFT
6-3/4" Actual Inside Width		
10" (9-3/4" Actual)	8' (96")	CWPMFLT10X10X96SFT
	9' (108")	CWPMFLT10X10X108SFT
	10' (120")	CWPMFLT10X10X120SFT
8-3/4" Actual Inside Width		

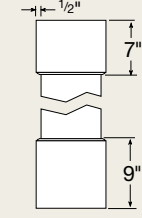

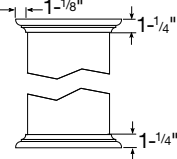
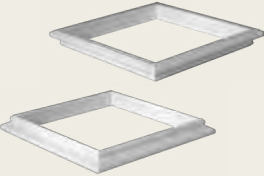
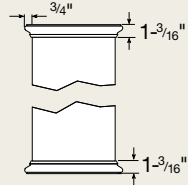

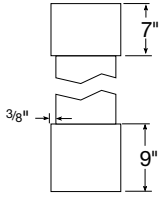
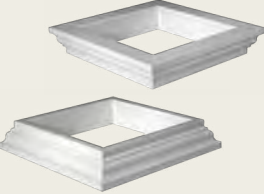
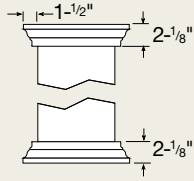
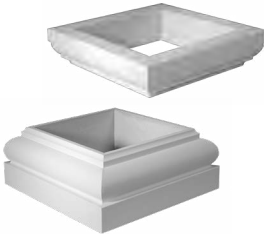
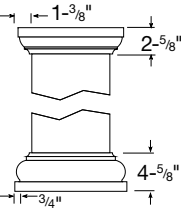
Square Cap & Base Accessories

Style	6" x 6"	8" x 8"	10" x 10"	12" x 12"
Traditional  	CWCB6TR	CWCB8TR	CWCB10TR	CWCB12TR
Ships standard with the semi-assembled PremiumSelect Square Column Wrap Kits.				
Craftsman  	CWCB6CF	CWCB8CF	CWCB10CF	CWCB12CF
Greek  	CWCB6GK	CWCB8GK	CWCB10GK	CWCB12GK
Plain  	CWCB6PL	CWCB8PL	CWCB10PL	CWCB12PL
Ships standard with the semi-assembled ProSelect Square Column Wrap Kits.				
Roman  	CWCB6RO	CWCB8RO	CWCB10RO	CWCB12RO
Tuscan  	CWCB6TS	CWCB8TS	CWCB10TS	CWCB12TS
Tuscan cap and base are high-density polyurethane.				
Neck Mould  	CW6NM	CW8NM	CW10NM	CW12NM



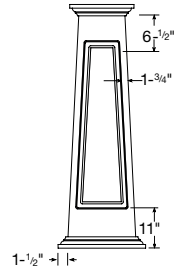
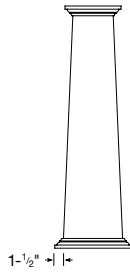

Route is 1-3/8" wide by 3/8" deep.

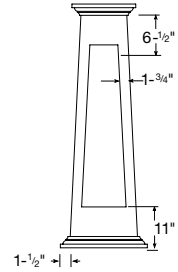

Recess is 1/2" deep and corners are 1/4" rounded.

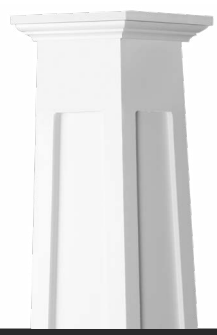
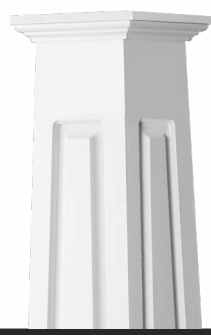
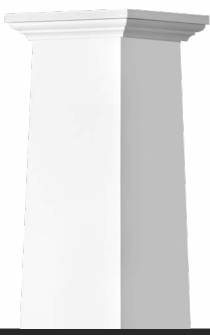

PremiumSelect

TAPERED COLUMN WRAPS

SEMI-ASSEMBLED WITH CRAFTSMAN CAP & BASE

Shaft Width	Height	Flat	Raised Panel	Recessed Panel	
8" Top (7-3/4" Actual)	4' (48")	CWPM8X12X48TFT	CWPM8X12X48TRS	CWPM8X12X48TRC	
	4-1/2' (54")	CWPM8X12X54TFT	CWPM8X12X54TRS	CWPM8X12X54TRC	
	5' (60")	CWPM8X12X60TFT	CWPM8X12X60TRS	CWPM8X12X60TRC	
	12" Bottom (11-3/4" Actual)	5-1/2' (66")	CWPM8X12X66TFT	CWPM8X12X66TRS	CWPM8X12X66TRC
	6' (72")	CWPM8X12X72TFT	CWPM8X12X72TRS	CWPM8X12X72TRC	
11" Top (10-3/4" Actual)	8' (96")	CWPM8X12X96TFT	CWPM8X12X96TRS	CWPM8X12X96TRC	
	4' (48")	CWPM11X16X48TFT	CWPM11X16X48TRS	CWPM11X16X48TRC	
	4-1/2' (54")	CWPM11X16X54TFT	CWPM11X16X54TRS	CWPM11X16X54TRC	
	5' (60")	CWPM11X16X60TFT	CWPM11X16X60TRS	CWPM11X16X60TRC	
	16" Bottom (15-3/4" Actual)	5-1/2' (66")	CWPM11X16X66TFT	CWPM11X16X66TRS	CWPM11X16X66TRC
13" Top (12-3/4" Actual)	6' (72")	CWPM11X16X72TFT	CWPM11X16X72TRS	CWPM11X16X72TRC	
	8' (96")	CWPM11X16X96TFT	CWPM11X16X96TRS	CWPM11X16X96TRC	
	4' (48")	CWPM13X20X48TFT	CWPM13X20X48TRS	CWPM13X20X48TRC	
	4-1/2' (54")	CWPM13X20X54TFT	CWPM13X20X54TRS	CWPM13X20X54TRC	
	5' (60")	CWPM13X20X60TFT	CWPM13X20X60TRS	CWPM13X20X60TRC	
20" Bottom (19-3/4" Actual)	5-1/2' (66")	CWPM13X20X66TFT	CWPM13X20X66TRS	CWPM13X20X66TRC	
	6' (72")	CWPM13X20X72TFT	CWPM13X20X72TRS	CWPM13X20X72TRC	
	8' (96")	CWPM13X20X96TFT	CWPM13X20X96TRS	CWPM13X20X96TRC	
	4' (48")	CWPM16X24X48TFT	CWPM16X24X48TRS	CWPM16X24X48TRC	
	16" Top (15-3/4" Actual)	4-1/2' (54")	CWPM16X24X54TFT	CWPM16X24X54TRS	CWPM16X24X54TRC
24" Bottom (23-3/4" Actual)	5' (60")	CWPM16X24X60TFT	CWPM16X24X60TRS	CWPM16X24X60TRC	
	5-1/2' (66")	CWPM16X24X66TFT	CWPM16X24X66TRS	CWPM16X24X66TRC	
	6' (72")	CWPM16X24X72TFT	CWPM16X24X72TRS	CWPM16X24X72TRC	
	8' (96")	CWPM16X24X96TFT	CWPM16X24X96TRS	CWPM16X24X96TRC	
	8' (96")	CWPM16X24X96TFT	CWPM16X24X96TRS	CWPM16X24X96TRC	

Column Wraps



PremiumSelect Flat-Pack

TAPERED COLUMN WRAPS

UNASSEMBLED PVC SHAFT

FEATURES:

- PremiumSelect tapered style features a flat-panel shaft.
- Accessories are sold separately, allowing you to create a custom look. See page 243 for additional options.
- Exterior cleat included for easy installation.
- Installation materials sold separately. See page 230.
- Product ships flat for easy handling or storage.
- Cap and base sold separately.







Shaft Width	Height	Flat Panel (FT)
8" Top (7-3/4" Actual)	5' (60")	CWPMFLT8X12X60TFT
12" Bottom (11-3/4" Actual)	5-1/2' (66")	CWPMFLT8X12X66TFT
	6' (72")	CWPMFLT8X12X72TFT
11" Top (10-3/4" Actual)	5' (60")	CWPMFLT11X16X60TFT
16" Bottom (15-3/4" Actual)	5-1/2' (66")	CWPMFLT11X16X66TFT
	6' (72")	CWPMFLT11X16X72TFT



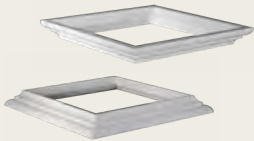
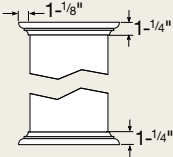

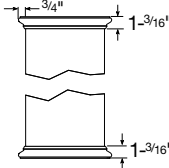
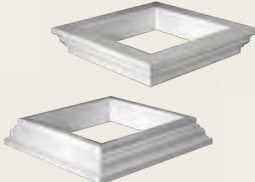
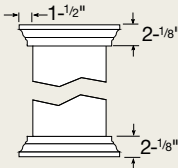
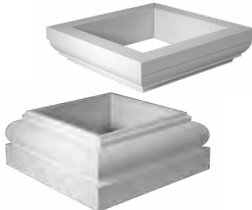
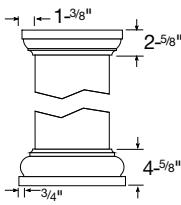
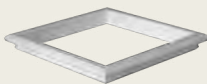
Tapered Cap & Base Accessories

Style	6" x 6"	8" x 8"	10" x 10"	12" x 12"
Craftsman  	CWCB8X12CF	CWCB11X16CF	CWCB13X20CF	CWCB16X24CF
Ships standard with semi-assembled PremiumSelect Tapered Column Wrap Kits.				
Greek  	CWCB8X12GK	CWCB11X16GK	CWCB13X20GK	CWCB16X24GK
Roman  	CWCB8X12RO	CWCB11X16RO	CWCB13X20RO	CWCB16X24RO
Tuscan  	CWCB8X12TS	CWCB11X16TS	CWCB13X20TS	CWCB16X24TS
Tuscan cap and base are high-density polyurethane.				
Neck Mould  	CW17NM	Trimmable to fit up to 16" wide top width.		

Column Wraps



EverCedar

WOOD-GRAINED FLAT-PACK SQUARE COLUMN WRAPS

UNASSEMBLED WITH STANDARD CAP & BASE

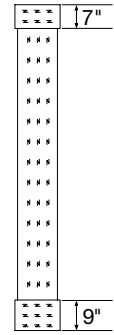

Shaft Width	Height	Flat Panel (FT)
6" (5-3/4" Actual)	8' (96")	CWEVFLT6X96SFT
	9' (108")	CWEVFLT6X108SFT
	10' (120")	CWEVFLT6X120SFT
4-1/4" Actual Inside Width		
8" (7-3/4" Actual)	8' (96")	CWEVFLT8X96SFT
	9' (108")	CWEVFLT8X108SFT
	10' (120")	CWEVFLT8X120SFT
6-1/4" Actual Inside Width		
10" (9-3/4" Actual)	8' (96")	CWEVFLT10X96SFT
	9' (108")	CWEVFLT10X108SFT
	10' (120")	CWEVFLT10X120SFT
8-1/4" Actual Inside Width		
12" (11-3/4" Actual)	8' (96")	CWEVFLT12X96SFT
	10' (120")	CWEVFLT12X120SFT
10-1/4" Actual Inside Width		



EverCedar

WOOD-GRAINED FLAT-PACK TAPERED COLUMN WRAPS
UNASSEMBLED WITH STANDARD CAP & BASE

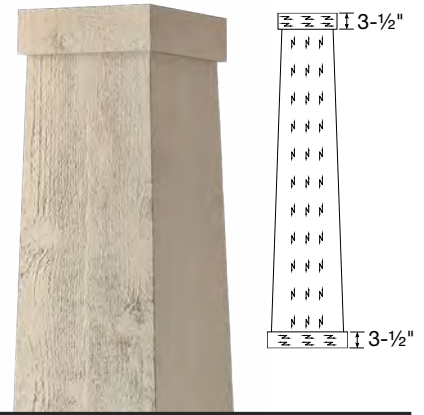

Shaft Width	Height	Flat
11" Top (10-3/4" Actual)	4' (48")	CWEVFLT11X16X48TFT
16" Bottom (15-3/4" Actual)	6' (72")	CWEVFLT11X16X72TFT



Column Wraps





A photograph of a house with a white railing and a window showing a view of mountains. The railing is white with decorative balusters. The window is large and shows a view of mountains and a house. The railing is in the foreground, and the window is in the background.

Beauty made easy.

Discover beautiful railings, made more durable through our special manufacturing process. Low-maintenance and resistant to decay, our railing products come with simple, step-by-step installation instructions, ensuring they live up to their name.

RAIL SYSTEMS

- 252 Premium Straight Rail Kits
- 253 Premium Stair Rail Kits
- 253 Premium Gate Kits
- 254 Post Kits
- 255 Post Sleeves & Accessories
- 256 Bracket & Adapter Kits
- 257 Individual Components
- 258 QuickPost Porch Post
- 259 DuraPoly Porch Post

Railing Systems

HOW TO USE THIS SECTION

For ease of use, the product groupings in this section of the catalog are organized by size and style. Each product chart includes product images, dimensional data and part numbers to help specify, source and sell Fypon® rail systems.

HOW TO ORDER RAIL SYSTEMS

Rail kits are available for both straight and stair applications. Each kit includes a top rail, a bottom rail, spindles, a crush block¹, brackets, bracket covers and the necessary screws for fast installation. Rail kits can be attached to a wall, newel post or porch post.

Plan your layout by determining the size and configuration of your porch or deck, including any stairs. The most important step to building your order is creating an accurate layout. Check local building codes to determine minimum guardrail height, maximum rail span and structural post requirements for your area. Determine the number of rail and post kits you need to accommodate your layout.

Next, choose your spindle style. Then find the part number of the rail kit that meets your style, length and height requirements.

Finally, determine size and style of any accessories needed to achieve the desired look.

HOW TO ORDER RAIL SYSTEM ACCESSORIES

A variety of accessories are available to create your own unique system, including post kits, post sleeves and porch posts. If you have an application where additional or unique connections are required, bracket and adapter kits are sold separately. Individual components are also sold separately.

BUILDING CODE COMPLIANCE

Fypon rail system products are building-code compliant over 30" above ground when rail lengths are 8' or less installed between our Ultra Post Kits, or approved wood post construction. 10' and 12' rail lengths shall only be attached directly to supporting structure (i.e. wall or support column). Applications 30" or less above ground are decorative, and do not fall under any building code or testing standard. The 8', 10' and 12' rail kits include a top rail metal insert that must be used in any installation. 6' rail kits do not require an insert.

Fypon has received confirmation from ICC-ES that QuickRail Premium guardrail systems comply with the International Building Code (IBC) and International Residential Code (IRC). The published evaluation report ESR-2601 is available online at icc-es.org/report-listing/esr-2601.

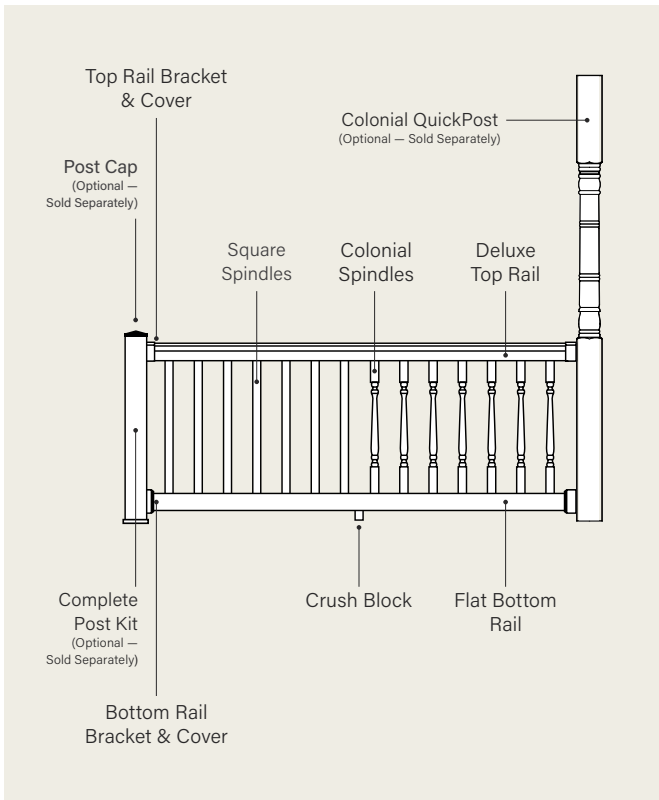

¹6' Stair Rail Kits do not include crush block.

Note: Always consult the local building code authority to determine suitability of products to meet specific project requirements. Stair Rail Kits cannot be attached to 45-degree post applications.



Premium Railing

PREMIUM RAIL KITS

OPTIONS & FEATURES:

- Height Options: 36" or 42" rail height
- Length Options: 6', 8', 10' or 12' nominal lengths
- Spindle Options: Colonial or Square
- Finish Color: White
- Baluster Spacing: Depending on rail length and spindle style selected, the spacing will vary slightly.
- Application: Straight or Stair (32- to 37-degree slope)
- Additional Accessories: Multi-angle brackets and 45-degree adapters are available as special order.

KIT CONTENTS

STRAIGHT & STAIR RAIL KITS:

Each Rail Kit includes the following:

- Top Rail
- Top Rail Structural Insert¹
(Included in kits over 6' for necessary support.)
- Bottom Rail
- Colonial or Square Spindles
- Crush Block²
- Brackets and Bracket Covers
- Screw Pack

STRAIGHT RAIL KITS



SQUARE

Description	6' Kits	8' Kits	10' Kits	12' Kits
Square Spindles	Actual length 72"	Actual length 96"	Actual length 120"	Actual length 144"
36" Rail Height	740636SQDF	740836SQDF	741036SQDF	741236SQDF
42" Rail Height	740642SQDF [◆]	740842SQDF	741042SQDF	741242SQDF

COLONIAL

Description	6' Kits	8' Kits	10' Kits	12' Kits
Colonial Spindles	Actual length 70-1/2"	Actual length 94-1/8"	Actual length 117-3/4"	Actual length 141"
36" Rail Height	740636CLDF	740836CLDF	741036CLDF	741236CLDF [◆]

[◆] Special order.

¹6' Kit meets code without the need of a structural insert.

²Crush block is not included in 6' Stair Kit.

Note: Always consult the local building code authority to determine suitability of products to meet specific project requirements.

8', 10' and 12' Rail Kits include aluminum rail insert for added support. Aluminum inserts come in kits only. Posts are sold separately from kits.

Stair Rail Kits

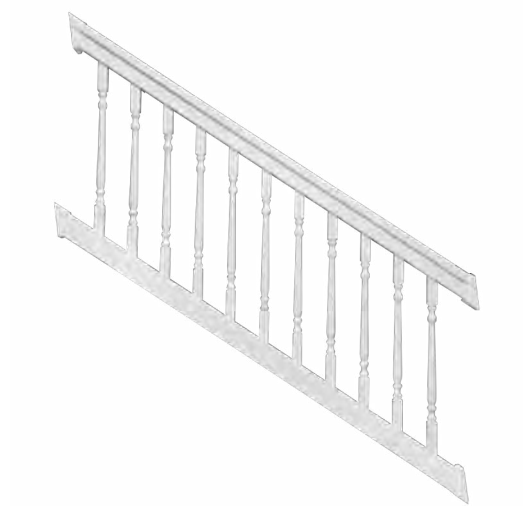

SQUARE

Description	6' Kits	8' Kits	10' Kits	12' Kits
Square Spindles	Actual length 78"	Actual length 102"	Actual length 126"	
36" Rail Height	740636SQDS	740836SQDS	741036SQDS	—
42" Rail Height	740642SQDS	740842SQDS	741042SQDS	—

COLONIAL

Description	6' Kits	8' Kits	10' Kits	12' Kits
Colonial Spindles	Actual length 78"	Actual length 102"	Actual length 126"	
36" Rail Height	740636CLDS	740836CLDS	741036CLDS	—

GATE KITS



Gate Kits come with a latch, hinges and mounting hardware, and are available in 36" and 42" heights. The Gate Kit components are pre-cut to fit a 36-1/2" wide opening but can be trimmed for smaller applications. Be sure to check local building codes for any dimension requirements when planning your system layout.

Improved Hinges and Latch

Nylon spring-loaded gate hinges and locking entry latch provide a durable, quiet, lighter weight connection between the gate and posts with added security.



Description	Spindle Style	Gate Width	Kit Height	Part Number
35" x 36" Gate Kit	Square	35"	36"	4436SQDFGK
35" x 36" Gate Kit	Colonial	35"	36"	4436CLDFGK
35" x 42" Gate Kit	Square	35"	42"	4442SQDFGK

IMPORTANT: Gate Kit should NOT be attached to Complete Post Kit. It is recommended to attach the Gate Kit to a structural 4 x 4 or 5 x 5 treated post covered with a post sleeve.
 Note: This product should only be installed on structural surfaces less than 30" or less above ground unless approved by building inspector for higher elevations.

Post Kits





COMPLETE POST KITS (FOR ELEVATIONS 30" OR LESS ABOVE GROUND)

The Complete Post Kit comes with a standard post mount and can be used to connect rail sections on substrates with elevations 30" or less above ground. Complete Post Kits include a cap, base, standard PVC post mount and the necessary hardware for installation on both pressure-treated wood decking and masonry surfaces.

Description	4" x 4"	5" x 5"	
	Complete Post Kit	Inside width 3-5/8"	Inside width 4-5/8"
 <p>Standard Mount</p>	38" Height	40050438PK	40050538PK 
	44" Height	40050444PK	40050544PK 
	Hardware Kit	4005ACQHDR	4005ACQHDR

ULTRA POST KITS (FOR ELEVATIONS MORE THAN 30" ABOVE GROUND)

The ultra post is a structural newel post that can be used on substrates more than 30" or less above ground. Ultra Post Kits include a cap, base, structural post mount and the necessary hardware for installation on either wood / composite or concrete / masonry surfaces.

Description	4" x 4"	4" x 4"
	Wood or Composite Substrate	Concrete or Masonry Substrate
Ultra Post Kit	Inside width 3-5/8"	Inside width 3-5/8"
 <p>Structural Post Mount</p>	38" Height	70050438WPK  70050438CPK 
	44" Height	70050444WPK 











 Special order.

254 Note: When installed in accordance with written instructions, straight rail systems are code compliant 30" and greater above ground when used with Ultra Post Kit.

System Accessories

POST SLEEVES

The post sleeve is a one-piece, hollow design that slides over an existing 4 x 4 or 5 x 5 support post.

Description	4" x 4"	5" x 5"
	Inside width 3-5/8"	Inside width 4-5/8"
 Post Sleeve		
38" Height	40050438PS	40050538PS 
44" Height	40050444PS 	40050544PS 
48" Height	40050448PS 	—
60" Height	40050460PS 	—
96" Height	40050408PS 	40050508PS 
108" Height	40050409PS 	40050509PS 

ACCESSORIES

Post sleeves can be accented with a variety of caps and bases to customize your system.

Description	Fits 4" x 4"	Fits 5" x 5"
 Taper Cap	40040404TC	40040505TC 
 New England Cap	40040404NC 	40040505NC 
 New England Base	40040404PB 	40040505PB 



Bracket & Adapter Kits



(2) Top Rail Brackets



(2) Top Rail Bracket Covers



(2) Bottom Rail Brackets



(2) Bottom Rail Bracket Covers



(2) Screw Packs (Qty. 16)

Description

Part Number (Fits all Premium Rail Kit lengths)

Straight Rail Bracket Kit

440900DFBK 



(1) Top Rail Upper Stair Bracket Cover



(1) Top Rail Lower Stair Bracket Cover



(1) Bottom Rail Upper Stair Bracket Cover



(1) Bottom Rail Lower Stair Bracket Cover



(2) Top Rail Brackets



(2) Bottom Rail Brackets



(2) Screw Packs (Qty. 16)

Description

Part Number (Fits all Premium Rail Kit lengths)

Stair Rail Bracket Kit

4409DFSUBK 



(1) Top Rail Multi-Angle Connector



(1) Bottom Rail Multi-Angle Connector



(1) Top Rail Multi-Angle Pivot Bracket



(1) Bottom Rail Multi-Angle Pivot Bracket



(1) Screw Pack (Qty. 12)



(1) Rod Pack (Qty. 2 Rods; 4 Caps)

Description

Part Number (Fits all Premium Rail Kit lengths)

Multi-Angle Bracket Kit

44070DFMBK 



(1) Top Rail 45-Degree Adapter



(1) Bottom Rail 45-Degree Adapter



(1) Screw Pack (Qty. 8)

Description

Part Number (Fits all Premium Rail Kit lengths)

45-Degree Corner Post Bracket Kit

74070FFPBK 

Individual Components



Top Rail



Bottom Rail

Aluminum Insert required for any rail length over 6' to meet code. Order one insert per top rail. Insert is 12' long.

STRAIGHT RAILS

Description	6' Rails	8' Rails	10' Rails	12' Rails
For Square Spindles	Actual length 72"	Actual length 96"	Actual length 120"	Actual length 144"
Top Rail	4407060STR	4407080STR	4407010STR	4407012STR
Bottom Rail	4007060SBR	4007080SBR	4007010SBR	4007012SBR
For Colonial Spindles	Actual length 70-1/2"	Actual length 94-1/8"	Actual length 117-3/4"	Actual length 141"
Top Rail	4407060CTR	4407080CTR	4407010CTR	4407012CTR
Bottom Rail	4007060CBR	4007080CBR	4007010CBR	4007012CBR
Aluminum Insert	—	44070012AI	44070012AI	44070012AI

Note: Hole spacing will vary slightly based on rail length selected or spindle style. To ensure holes align properly, select the same length top rail as bottom rail. And the same rails for either square spindles or colonial spindles.

STAIR RAILS

Description	6' Rails	8' Rails	10' Rails	12' Rails
For Square or Colonial Spindles	Actual length 78"	Actual length 102"	Actual length 126"	
Top Rail	4407060SSR	4407080SSR	4407010SSR	—
Bottom Rail	4007060SLR	4007080SLR	4007010SLR	—



Colonial Spindle



Square Spindle

SPINDLES

Description	6' Rails	8', 10', and 12' Rails
For 36" Rail Height	Actual height 33-1/2"	Actual height 32-3/4"
Square Spindles	40043305SS	44043275SS
Colonial Spindles	40043305CS	44043275CS
For 42" Rail Height	Actual height 39-1/2"	Actual height 38-3/4"
Square Spindles	40043905SS	44043875SS

QuickPost Porch Post



Do not paint

STRUCTURAL POST WITH LIFETIME FINISH

QuickPost synthetic porch posts are the perfect complement to our rail systems. Featuring the same lifetime finish as all rail system components, the vibrant color is low maintenance and never needs to be painted.

- Structural post features steel insert.
- Choose from traditional Colonial or modern Square styles.
- Trim to fit your project.
- Designed for use with rail systems.
- Very low maintenance.
- Backed by a lifetime limited warranty.

PRODUCT DETAILS

- Shell is composed of UV-protected vinyl.
- Internal core includes a structural, galvanized steel tube.
- Kit includes mounting plates and screws.

PRODUCT DETAILS

- Sizes: 5" and 6" are nominal for Colonial styles.
- Sizes: 4" and 5" are actual for Square styles.
- Accessories: Trim Kit available (sold separately).

QUICKPOST PORCH POST

Colonial Porch Post	5" x 5" Colonial	6" x 6" Colonial	
	Actual Width	4-1/4"	5-1/4"
	Load-Bearing Capacity	3,000#	5,000#
	104" Post Height	40500588CL	40500688CL

Square Porch Post	4" x 4" Square	5" x 5" Square	
	Actual Width	4"	5"
	Load-Bearing Capacity	3,000#	5,000#
	104" Post Height	40500488SQ	40500588SQ

QUICKPOST TRIM KITS (SOLD SEPARATELY FROM POST)

Colonial Cap & Base Kit	5" Kit fits 5" x 5" Colonial	6" Kit fits 6" x 6" Colonial
	40020505TK ♦	400600PWTKV

Note: Cap and base included in kit part code.

Square Cap & Base Kit	4" Kit fits 4" x 4" Square	5" Kit fits 5" x 5" Square
	405004SQTK	405005SQTK

Note: Installation cleats ship with column wrap and are applied on the exterior shaft.

♦ Special order.
 Note: See your Fypon seller or visit fypon.com for details on limited warranties and exclusions.
 Dimensional drawings are approximate representations. Do not scale.

DuraPoly® Porch Post



Optional paintable finish allows for unique customization.

DURAPOLY PORCH POST

Colonial Porch Post	5" x 5" Colonial	6" x 6" Colonial	
	Actual Width	4-1/4"	5-1/4"
	Load-Bearing Capacity	3,000#	5,000#
95-7/8" Post Height	80500508CL-1	80500608CL-1	
103-7/8" Post Height	80500588CL	80500688CL	



DURAPOLY TRIM KITS (SOLD SEPARATELY FROM POST)

Colonial Cap & Base Kit	5" Kit fits 5" x 5" Colonial	6" Kit fits 6" x 6" Colonial
	800500PWTK	800600PWTK

Note: Cap and base included in kit part code.







Add outdoor sophistication.

Transform any porch, patio or balcony into an impressive outdoor living area. An eye-catching accent for many home designs, our balustrades, porch posts and columns are beautiful and durable.

BALUSTRADES, PORCH POSTS & COLUMNS

- 266 5" Balustrade System
- 268 7" Balustrade System
- 270 Newel Posts
- 271 Newel Post Installation Kit
- 272 Post Accessories
- 274 Porch Spandrels
- 275 Porch Posts
- 275 Panel Square Column
- 277 Wood-Grained Column

Balustrades, Porch Posts & Columns

HOW TO ORDER BALUSTRADE SYSTEMS

Our smooth balustrade systems are available in two sizes: 5" and 7". This size designates the width of the top and bottom rail.

PLANNING YOUR BALUSTER LAYOUT

For each baluster, we have noted a center spacing dimension. This is the maximum center-to-center distance between balusters that does not allow a 4" sphere to pass through at any point. The number of balusters you need can be found by dividing the rail span, in inches, by the center spacing dimension shown under each part.

Note: If dividing gives you a fractional result, always round up to the next whole number as shown in the example.

RAIL INSTALLATION KITS

Each rail section (span between two newel posts) will require two Rail Installation Kits. Rail Installation Kits will connect both ends of one rail to a newel post or column.

Note: Rail Installation Kits will not work on stair applications. Top and bottom rails do not come pre-drilled.

NEWEL POSTS

Each newel post will require one Newel Post Installation Kit to anchor the base of the post, as well as any post tops, balls or trim collars desired.

BALUSTRADE SYSTEM ACCESSORIES

Balustrade system accessories are available to help achieve your desired look. All balustrade accessories are unattached and must be ordered separately.

STRUCTURAL PORCH POSTS AND COLUMNS

Structural porch posts and columns are reinforced and have load-bearing capacities as noted. Installation hardware is included. Simply choose the column or porch post desired in a height that is equal to or slightly larger than the required height. Porch posts and columns can be trimmed to various lengths without impacting load rating. Be sure to order the appropriate quantity of porch posts and columns to adequately support the weight of the load they will carry.

BALUSTER EXAMPLE

BAL5X24AY requires 7-³/₈" on-center spacing.

Rail Span ÷ Center Spacing =
Number of Balusters Needed

$96 \div 7.375 = 13.02$

Round up to 14 balusters.

Straight Rail Application

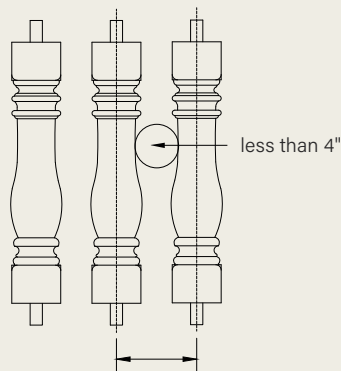

Center-to-Center Distance

Stair Rail Application

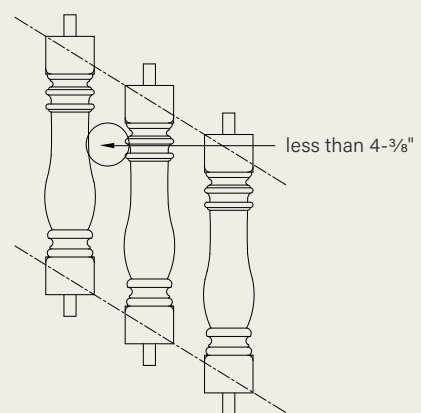



Balustrade Example

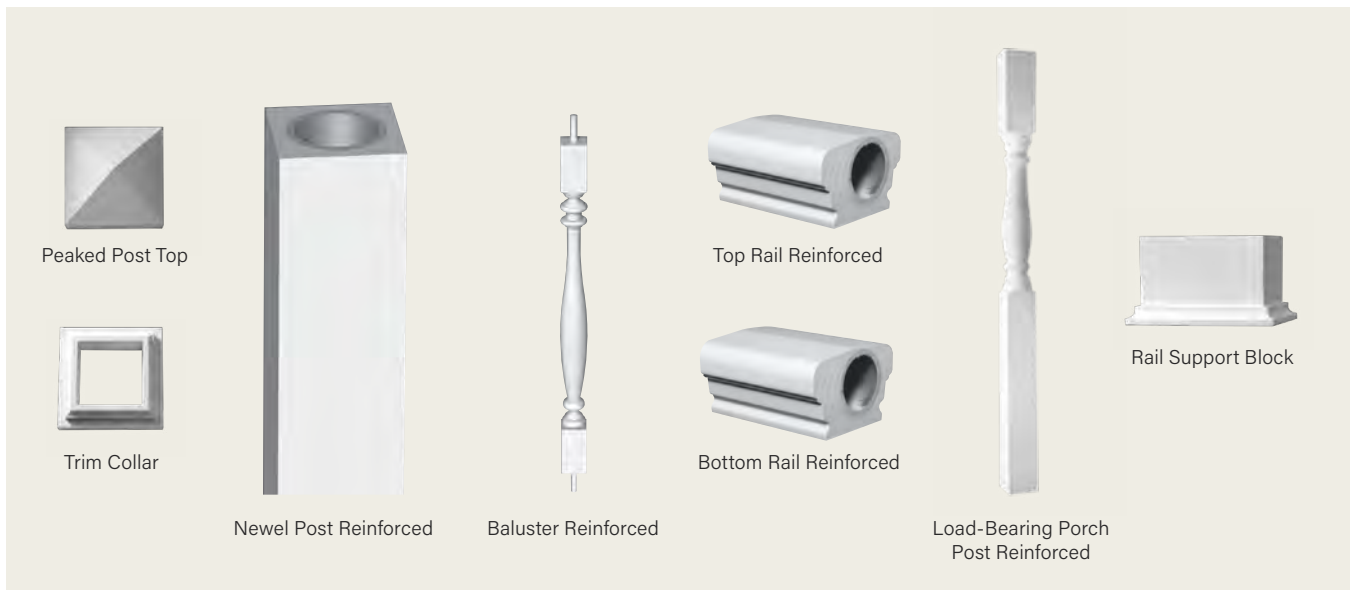
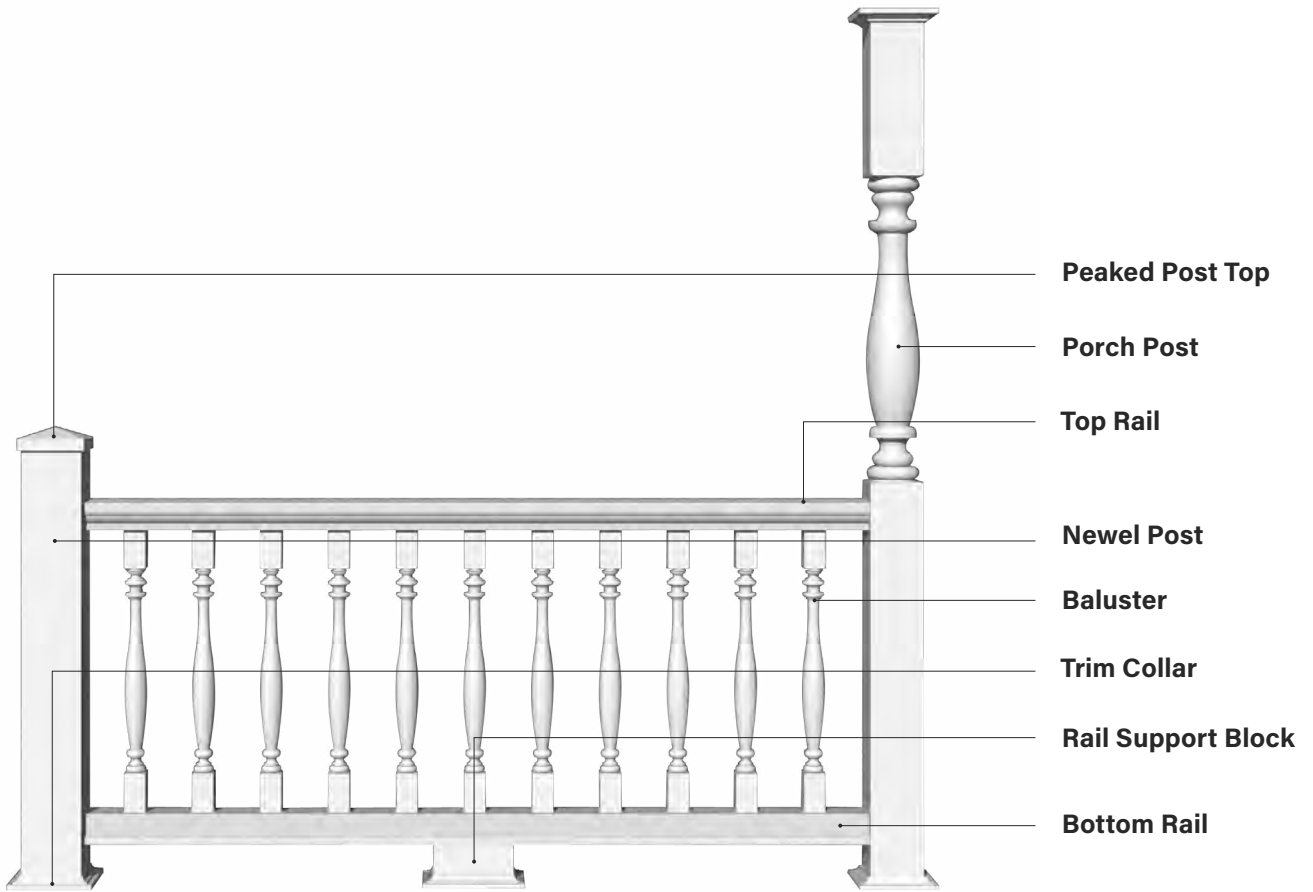

Note: Balusters are polyurethane. Baluster images shown may not be an accurate representation of every size within each category. For additional line art images, visit fypon.com.



5" Balustrade System

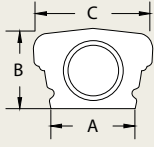

TOP STRAIGHT RAILS

Top Rail	Part Number	Balustrade Rail System	Length	A	B	C	
	BTR5X9	5"	96"	3-1/4"	3-1/8"	4-5/8"	
	BTR5X144 ¹	5"	144"	3-1/4"	3-1/8"	4-5/8"	

BOTTOM STRAIGHT RAILS

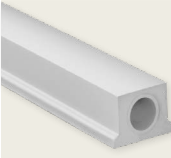
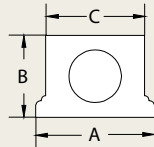
Bottom Rail	Part Number	Balustrade Rail System	Length	A	B	C	
	BBR5X96	5"	96"	4-1/2"	3-1/8"	3-3/4"	
	BBR5X144 ¹	5"	144"	4-1/2"	3-1/8"	3-3/4"	

BALUSTRADE RAIL INSTALLATION AIDS

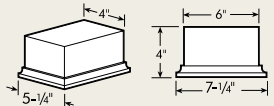
	Part Number	Installation Notes	
	RSB4X4X6 Rail Support Block	Install under the bottom rail at a span of 48" or less. Dimensions: 4" x 4" x 7-1/4" (must be trimmed for height).	



BRK5
Rail Installation Kit

Connects both ends of one 5" top or bottom rail to support structure. Order two kits per section. Kit Contents: (2) Angle Brackets & Mounting Hardware

¹Maximum rail span distance for field application is 96" with a support block used every 48". 120" and 144" rails are meant to be cut down in field. For example: Reduce waste by ordering 120" to create two smaller 84" and 36" sections.
Note: Assembly shown with Ashley Balusters.

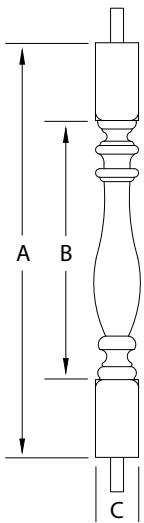

Ashley



Woodruff



Classic



Logan



Square

5" System	Part Number	Height (A)	Height (B)	Width (C)	Maximum Center-to-Center Spacing	Can be Used on Stairs
Ashley	BAL2.5X15AY	15"	9"	2-1/2"	5-3/8"	Yes
	BAL3X20AY	20"	15"	2-1/2"	5-3/8"	Yes
	BAL3X24AY	24"	15"	2-1/2"	5-3/8"	Yes
	BAL3X28AY	28"	19"	2-1/2"	5-3/8"	Yes
	BAL3X32AY	32"	23"	2-1/2"	5-3/8"	Yes
	BAL3X36AY	36"	24"	2-1/2"	5-3/8"	Yes
Woodruff	BAL3X18WF	18"	10"	2-1/2"	5-1/8"	Yes
	BAL3X20WF	20"	12"	2-1/2"	5-1/8"	Yes
	BAL3X24WF	24"	16"	2-1/2"	5-1/8"	Yes
	BAL3X28WF	28"	20"	2-1/2"	5-1/8"	Yes
	BAL3X32WF	32"	24"	2-1/2"	5-1/8"	Yes
Classic	BAL3X20CC	20"	13"	2-1/2"	5"	Yes
	BAL3X24CC	24"	17"	2-1/2"	5"	Yes
	BAL3X28CC	28"	21"	2-1/2"	5"	Yes
	BAL3X32CC	32"	25"	2-1/2"	5"	Yes
Logan	BAL3X24LN	24"	18"	3"	5-1/2"	Yes
	BAL3X28LN	28"	22"	3"	5-1/2"	Yes
Square	BAL2X24SQ	24"	-	1-3/4"	5-3/4"	Yes
	BAL2X28SQ	28"	-	1-3/4"	5-3/4"	Yes
	BAL2X32SQ	32"	-	1-3/4"	5-3/4"	Yes

Note: Baluster images shown may not be an accurate representation of every size within each category. For additional line art images, visit fypon.com. Stairs with four or more risers are required to be compliant with the IRC/IBC. Please check with the local building official for compliance.

7" Balustrade System



TOP STRAIGHT RAILS

Top Rail	Part Number	Balustrade Rail System	Length	A	B	C
	BTR7X96	7"	96"	5-1/2"	5-1/4"	7"
	BTR7X120 ¹	7"	120"	5-1/2"	5-1/4"	7"
	BTR7X144 ¹	7"	144"	5-1/2"	5-1/4"	7"

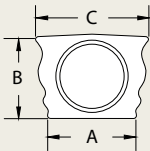

TOP STRAIGHT RAILS

Bottom Rail	Part Number	Balustrade Rail System	Length	A	B	C
	BBR7X96	7"	96"	7"	5-1/4"	5-1/2"
	BBR7X120 ¹	7"	120"	7"	5-1/4"	5-1/2"
	BBR7X144 ¹	7"	144"	7"	5-1/4"	5-1/2"

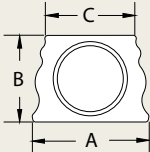

BALUSTRADE RAIL INSTALLATION AIDS

Part Number	Installation Notes
 RSB4X4X6 Rail Support Block	Install under the bottom rail at a span of 48" or less. Dimensions: 4" x 4" x 7-1/4" (must be trimmed for height).

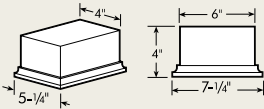

 BRK6-7 Rail Installation Kit	Connects both ends of one 7" top or bottom rail to support structure. Order two kits per section. Kit Contents: (2) Angle Brackets & Mounting Hardware
--	--

¹Maximum rail span distance for field application is 96" with a support block used every 48". 120" and 144" rails are meant to be cut down in field. For example: Reduce waste by ordering 120" to create two smaller 84" and 36" sections.
Note: Assembly shown with Woodruff Balusters.

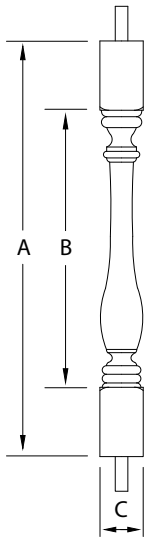

Ashley



Woodruff



Classic



Beaumont



Rosedale

7" System	Part Number	Height (A)	Height (B)	Width (C)	Maximum Center-to-Center Spacing	Can be Used on Stairs
Ashley	BAL4X24AY	24"	15"	4-1/2"	7-3/8"	Yes
	BAL5X24AY	24"	17"	4-1/2"	7-3/8"	Yes
Woodruff	BAL5X28WF	28"	20"	4-1/2"	7-1/8"	Yes
Classic	BAL5X20CC	20"	10"	5"	7-1/2"	Yes
	BAL5X24CC	24"	14"	5"	7-1/2"	Yes
	BAL5X28CC	28"	18"	5"	7-1/2"	Yes
	BAL5X30CC	30-1/2"	20-1/2"	5"	7-1/2"	Yes
	BAL5X32CC	32"	22"	5"	7-1/2"	Yes
	BAL4X27CCOB	27"	19"	4-1/4"	5-3/4"	Yes
	BAL4X31CCOB	31"	23"	4-1/4"	5-3/4"	Yes
	BAL5X28CCOB	28"	21-1/8"	4-1/2"	5-3/4"	Yes
Beaumont	BAL4X22BE	22"	19-1/8"	4"	6-1/4"	No
	BAL5X19BE	19-1/8"	16-1/4"	5-1/4"	6-3/4"	No
	BAL5X22BE	22"	16-1/8"	5"	7-1/8"	No
Rosedale	BAL5X20RL	20"	12"	4-1/2"	6-5/8"	Yes

Note: Baluster images shown may not be an accurate representation of every size within each category. For additional line art images, visit fypon.com.
Stairs with four or more risers are required to be compliant with the IRC/IBC.
Please check with the local building official for compliance.

Newel Posts



PLAIN NEWEL POST

Part Number	Balustrade System	A	B	Accessories	Installation Kit
NP6X48	5"	48"	5-1/2"	PST6X6FP PST7X7F TC6	NPK400
NP8X48	5", 7"	48"	7-1/2"	PST8X8FP PST10X10F TC8	NPK600



DECORATIVE NEWEL POST

Part Number	Balustrade System	A	B	Accessories	Installation Kit
NP10X48	5", 7"	48"	10"	PST11X11FP	NPK10



STRAIGHT PANEL NEWEL POST

Part Number	Balustrade System	A	B	Accessories	Installation Kit
NPSP8X48	5", 7"	48"	8"	PST9X9FP PST10X10F TC8-8	NPK600
NPSP13X48	5", 7"	48"	12-1/2"	PST13X13FP PST14X14F	NPK13



Note: Porch / deck surface pictured above was 30" or less above grade.

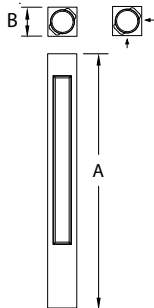

CORNER PANEL NEWEL POST

Part Number	Balustrade System	A	B	Accessories	Installation Kit
NPCP8X48	5", 7"	48"	8"	PST9X9FP PST10X10F TC8-8	NPK600
NPCP13X48	5", 7"	48"	12-1/2"	PST13X13FP PST14X14F	NPK13





NEWEL POST INSTALLATION KITS

Installation Kit	Kit Contents (Use one kit per post)
NPK10	Secures one 10" newel post to the structural substrate.
NPK13	Secures one 13" newel post to the structural substrate.
NPK400	Secures one 6" newel post to the structural substrate.
NPK600	Secures one 8" newel post to the structural substrate.

Newel Post Installation Kits are sold separately from the newel posts. Fasteners to mount steel base plate to the floor surface are not provided.

Note: All posts can be used with either 5" or 7" Rail Systems except NP6X48 which can only be used with the 5" Rail System.

Post Accessories

	Part Number	Coordinates with:
 <p>Ball Top</p>	B5X7	PST7X7F PST10X10F
	B10X13	PST14X14F
 <p>Flat Post Top</p>	PST7X7	B5X7 NP6X48
	PST10X10F	B5X7 NP8X48 NPCP8X48 NPSP8X48
	PST14X14F	B10X13 NPCP13X48 NPSP13X48
 <p>Fancy Peaked Top</p>	PST6X6FP	NP6X48
	PST8X8FP	NP8X48
	PST9X9FP	NPCP8X48 NPSP8X48
	PST11X11FP	NP10X48
	PST13X13FP	NPCP13X48 NPSP13X48
 <p>Trim Collar</p>	TC6	NP6X48
	TC8	NP8X48
	TC8-8	NPCP8X48 NPSP8X48



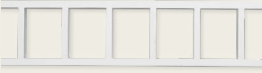
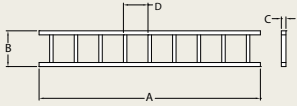

Porch Spandrels

	Part Number	Length (A)	Height (B)	Projection (C)	Design Repeat (D)	
	PRS48X8	48"	7-3/4"	1"	5-1/4"	

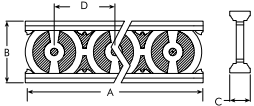
	PRS96X8	97-1/2"	8-1/4"	2-7/8"	8-1/8"	
---	---------	---------	--------	--------	--------	---

Porch Posts

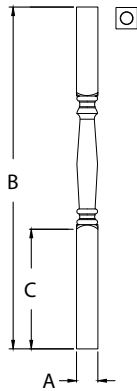

VINTAGE PORCH POST STRUCTURAL

Part Number	Width (A)	Overall Height (B)	Bottom Block Height (C)	Load-Bearing Capacity	Balustrade System
PP8X120A ¹	7-1/2"	120"	42"	12,000#	5", 7"

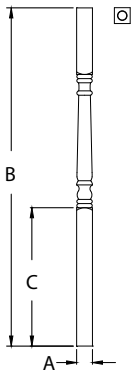

COLONIAL PORCH POST STRUCTURAL

Part Number	Width (A)	Overall Height (B)	Bottom Block Height (C)	Load-Bearing Capacity	Balustrade System
PP5X102 ¹	4-3/4"	101-1/4"	41-1/2"	6,000#	5"
PP6X96 ¹	5-1/2"	96"	44-1/2"	6,000#	5"
PP6X108 ¹	5-1/2"	108"	44-1/2"	6,000#	5"
PP6X120 ¹	5-1/2"	120"	44-1/2"	6,000#	5"

Panel Square Column

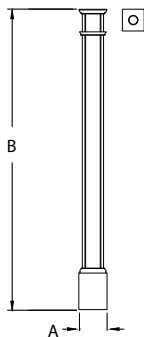

PANEL SQUARE COLUMN STRUCTURAL

Part Number	Width	Base Width (A)	Height (B)	Base Height	Load-Bearing Capacity
COL8X96PSQ ¹	6-1/8"	8"	96"	13-5/8"	12,000#
COL11X96PSQ ¹	8"	10-1/2"	96"	15-5/8"	12,000#
COL11X108PSQ ¹	8"	10-5/8"	108"	14-5/8"	12,000#

¹Installation kit included.

Note: Porch posts can be field trimmed to various heights without losing load rating.



Structural Wood-Grained Column

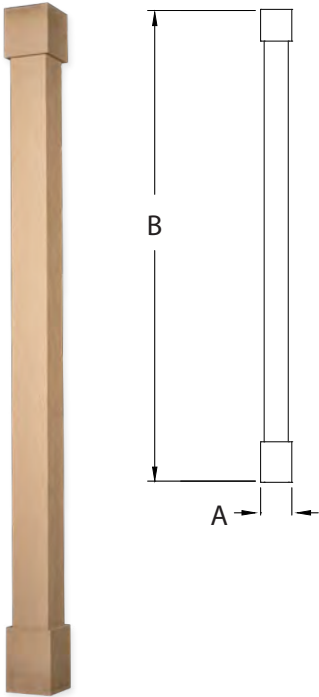

Part Number	Width (A)	Height (B)	Load-Bearing Capacity
PPSQKIT6X108S ¹	7"	108"	12,000#



¹Installation kit included. Column can be field trimmed to various heights without losing load rating. Cap is 9-5/8" x 7" and base is 9-5/8" x 9".

Adhesive & Finishing

A urethane-based adhesive such as Loctite® PL Premium® Construction Adhesive¹ must be used on all joints when installing urethane products. This will minimize the effects of expansion and contraction on the product. For additional information on adhesives, detailed installation instructions and finishing information, visit fypon.com.

LOCTITE® PL PREMIUM® ADHESIVE

	Part Number	Description
	ADH1	(1) 10.2 oz. Cartridge
	Loctite PL Premium Adhesive	

CONSIDERATIONS FOR INSTALLATION

Fypon reserves the right to make changes to our product with the assurance that we will meet or exceed quality requirements. Changes to product could include standardization across parts that may impact blocking applications, but visual impact will not be noticeable and parts will align. If it is critical to have consistency between parts for installation purposes, please speak with your Customer Service Representative prior to placing your order at 800.446.3040.

	Fypon Polyurethane	Wood	Composite
May Be Placed Against Masonry	Yes	No	No
Above-Grade Distance Requirement ²	0"	8"	6"
Water Absorption	No	Yes	Yes
Insect Resistant	Yes	No	No
Moisture Resistant	Yes	No	No
Pre-Drilling Required When Edge Nailing	No	Yes	Yes
Requires Sanding, Priming & Sealing	No	Yes	Yes
Painting (Number of Coats Needed) ³	1	2	2
Quality	Consistent quality, no waste; consistent finish	Natural variation; must be culled	
Versatility ²	Suitable options for interior or exterior application	Different grade of material and finish required for outdoor use	

Finishing Touches

PRIMER COLOR MATCH AVAILABLE AT SHERWIN-WILLIAMS®.

To better service our customers nationwide, we have worked with Sherwin-Williams¹ to formulate a color and sheen match for our factory-applied primer.

Fypon® White:

Resilience® Exterior Latex¹

Product # K42W51

Sheen: Flat

Base: Extra White

No colorant needs to be added to the formula.

Fypon® Oatmeal:

Resilience® Exterior Latex¹

Product # K43W00053

Sheen: Satin

Base: Deep Base

Quart and gallon formulas are shown below.

Quart Formula

W1 – White 4/32, 1/64

B1 – Black 7/32, 1/64, 1/128

R2 – Maroon 4/32

Y3 – Deep Gold 15/32, 1/64, 1/128

Gallon Formula

W1 – White 18/32

B1 – Black 31/32, 1/128

R2 – Maroon 15/32, 1/64

Y3 – Deep Gold 63/32

Fypon® Black® Primer:

SHER-WOOD® ACR: Millwork Primer¹

Product # E60BP102

¹Marks denoted by (°) are owned by third parties.

· Loctite PL Premium® is owned by Henkel IP & Holding GmbH.

· Sherwin-Williams is owned by SWIMC, Inc.

²Always consult the local building code authority to determine suitability of products to meet specific requirements, as well as adhesive manufacturer's recommendations for your particular climate and the substrate you are installing to.

³Fypon product must be painted within 90 days of installation or warranty is void.

Part Number	Page	Description
40020505TK	258	QUICKPOST TRIM KIT WHT
40040404NC	255	QR POST NEW ENGLAND CAP WHT
40040404PB	255	QR POST NEW ENGLAND BASE WHT
40040404TC	255	QR POST TAPER CAP WHT
40040505NC	255	QR POST NEW ENGLAND CAP WHT
40040505PB	255	QR POST NEW ENGLAND BASE WHT
40040505TC	255	QR POST TAPER CAP WHT
40043305CS	257	QR COLONIAL SPINDLE WHT
40043305SS	257	QR SQUARE SPINDLE WHT
40043905SS	257	QR SQUARE SPINDLE WHT
40050408PS	255	QR POST SLEEVE WHT
40050409PS	255	QR POST SLEEVE WHT
40050438PK	254	QR COMPLETE POST KIT WHT
40050438PS	255	QR POST SLEEVE WHT
40050444PK	254	QR COMPLETE POST KIT WHT
40050444PS	255	QR POST SLEEVE WHT
40050448PS	255	QR POST SLEEVE WHT
40050460PS	255	QR POST SLEEVE WHT
40050508PS	255	QR POST SLEEVE WHT
40050509PS	255	QR POST SLEEVE WHT
40050538PK	254	QR COMPLETE POST KIT WHT
40050538PS	255	QR POST SLEEVE WHT
40050544PK	254	QR COMPLETE POST KIT WHT
40050544PS	255	QR POST SLEEVE WHT
4005ACQHDR	254	QR HARDWARE FOR POST KIT
400600PWTK	258	QUICKPOST TRIM KIT WHT
4007010CBR	257	QR BOTTOM RAIL FOR COLONIAL SPINDLE WHT

Part Number	Page	Description
4007010SBR	257	QR BOTTOM RAIL FOR SQUARE SPINDLE WHT
4007010SLR	257	QR BOTTOM STAIR RAIL FOR COL/SQR SPINDLE WHT
4007012CBR	257	QR BOTTOM RAIL FOR COLONIAL SPINDLE 141IN WHT
4007012SBR	257	QR BOTTOM RAIL FOR SQUARE SPINDLE 144IN WHT
4007060CBR	257	QR BOTTOM RAIL FOR COLONIAL SPINDLE 70-1/2IN WHT
4007060SBR	257	QR BOTTOM RAIL FOR SQUARE SPINDLE 72IN WHT
4007060SLR	257	QR BOTTOM STAIR RAIL FOR COL/SQR SPINDLE 78IN WHT
4007080CBR	257	QR BOTTOM RAIL FOR COLONIAL SPINDLE 94-1/8IN WHT
4007080SBR	257	QR BOTTOM RAIL FOR SQUARE SPINDLE 96IN WHT
4007080SLR	257	QR BOTTOM STAIR RAIL FOR COL/SQR SPINDLE 102IN WHT
40500488SQ	258	PVC SQUARE QUICKPOST WHT
405004SQTK	258	QUICKPOST TRIM KIT WHT
40500588CL	258	PVC COLONIAL QUICKPOST WHT
40500588SQ	258	PVC SQUARE QUICKPOST WHT
405005SQTK	258	QUICKPOST TRIM KIT WHT
40500688CL	258	PVC COLONIAL QUICKPOST WHT
44043275CS	257	QR COLONIAL SPINDLE WHT
44043275SS	257	QR SQUARE SPINDLE WHT
44043875SS	257	QR SQUARE SPINDLE WHT
44070012AI	257	QR 12 FT ALUMINUM INSERT
4407010CTR	257	QR TOP RAIL FOR COLONIAL SPINDLE WHT
4407010SSR	257	QR DLX STAIR RAIL COL/SQR SPINDLE WHT
4407010STR	257	QR TOP RAIL FOR SQAURE SPINDLE WHT
4407012CTR	257	QR TOP RAIL FOR COLONIAL SPINDLE WHT
4407012STR	257	QR TOP RAIL FOR SQAURE SPINDLE WHT
4407060CTR	257	QR TOP RAIL FOR COLONIAL SPINDLE WHT
4407060SSR	257	QR TOP STAIR RAIL COL/SQR SPINDLE WHT

Part Number	Page	Description
4407060STR	257	QR TOP RAIL FOR SQUARE SPINDLE WHT
4407080CTR	257	QR TOP RAIL FOR COLONIAL SPINDLE WHT
4407080SSR	257	QR TOP STAIR RAIL COL/SQR SPINDLE WHT
4407080STR	257	QR TOP RAIL FOR SQUARE SPINDLE WHT
44070DFMBK	256	QR BRACKET KIT MULTI-ANGLE WHT
440900DFBK	256	QR BRACKET KIT STRAIGHT WHT
4409DFSUBK	256	BRACKET KIT STAIR WHT
4436CLDFGK	253	GATE KIT DLX W/COLONIAL SPINDLE WHT
4436SQDFGK	253	GATE KIT DLX W/SQUARE SPINDLE WHT
4442SQDFGK	253	GATE KIT DLX W/SQUARE SPINDLE WHT
70050438CPK	254	QR ULTRAPOST KIT - CONCRETE WHT
70050438WPK	254	QR ULTRAPOST KIT - WOOD/COMP WHT
70050444CPK	254	QR ULTRAPOST KIT - CONCRETE WHT
70050444WPK	254	QR ULTRAPOST KIT - WOOD/COMP WHT
740636CLDF	252	QR RAIL KIT DLX W/COLONIAL SPINDLE WHT
740636CLDS	253	QR STAIR KIT DLX W/COLONIAL SPINDLE WHT
740636SQDF	252	QR RAIL KIT DLX W/SQUARE SPINDLE WHT
740636SQDS	253	QR STAIR KIT DLX W/SQUARE SPINDLE WHT
740642SQDF	252	QR RAIL KIT DLX W/SQUARE SPINDLE WHT
740642SQDS	253	QR STAIR KIT DLX W/SQUARE SPINDLE WHT
74070FFPBK	256	ADAPTOR KIT 45 DEG CORNER WHT
740836CLDF	252	QR RAIL KIT DLX W/COLONIAL SPINDLE WHT
740836CLDS	253	QR STAIR KIT DLX W/COLONIAL SPINDLE WHT
740836SQDF	252	QR RAIL KIT DLX W/SQUARE SPINDLE WHT
740836SQDS	253	QR STAIR KIT DLX W/SQUARE SPINDLE WHT
740842SQDF	252	QR RAIL KIT DLX W/SQUARE SPINDLE WHT
740842SQDS	253	QR STAIR KIT DLX W/SQUARE SPINDLE WHT

Part Number	Page	Description
741036CLDF	252	QR RAIL KIT DLX W/COLONIAL SPINDLE WHT
741036CLDS	253	QR STAIR KIT DLX W/COLONIAL SPINDLE WHT
741036SQDF	252	QR RAIL KIT DLX W/SQUARE SPINDLE WHT
741036SQDS	253	QR STAIR KIT DLX W/SQUARE SPINDLE WHT
741042SQDF	252	QR RAIL KIT DLX W/SQUARE SPINDLE WHT
741042SQDS	253	QR STAIR KIT DLX W/SQUARE SPINDLE WHT
741236CLDF	252	QR RAIL KIT DLX W/COLONIAL SPINDLE WHT
741236SQDF	252	QR RAIL KIT DLX W/SQUARE SPINDLE WHT
741242SQDF	252	QR RAIL KIT DLX W/SQUARE SPINDLE WHT
800500PWTK	259	DURAPOLY POST TRIM KIT 5"
800600PWTK	259	DURAPOLY POST TRIM KIT 6"
80500508CL-1	259	DURAPOLY COLONIAL POST 5"X 5"
80500588CL	259	DURAPOLY COLONIAL POST 5"X 5"
80500608CL-1	259	DURAPOLY COLONIAL POST 6"X 6"
80500688CL	259	DURAPOLY COLONIAL POST 6"X 6"
A		
AP115	74	PEDIMENT ACORN ADJ SMOOTH
AP56	74	PEDIMENT ACORN SMOOTH
AP61	74	PEDIMENT ACORN SMOOTH
AP667	74	PEDIMENT ACORN SMOOTH
AP86	74	PEDIMENT ACORN SMOOTH
AP91	74	PEDIMENT ACORN SMOOTH
AP98	74	PEDIMENT ACORN SMOOTH
AR24X4F	69, 85	TRIM HALF ROUND ARCH FLAT SMOOTH
AR36X10MC	86	TRIM HALF RND ARCH DECO W/END CAP SMOOTH
AR36X10MFL108	87	TRIM HALF RND ARCH DECO W/FLANK SMOOTH
AR36X4F	85	TRIM HALF ROUND ARCH FLAT SMOOTH

Part Number	Page	Description
AR36X4M	85	TRIM HALF ROUND ARCH DECORATIVE SMOOTH
AR36X6F	86	TRIM HALF ROUND ARCH FLAT SMOOTH
AR36X6M	86	TRIM HALF ROUND ARCH DECORATIVE SMOOTH
AR37X4F	85	TRIM HALF ROUND ARCH FLAT SMOOTH
AR40X54PSK	77	PEDIMENT HALF RND SNBST W/T & KEY SMOOTH
AR40X6M	86	TRIM HALF ROUND ARCH DECORATIVE SMOOTH
AR48X4F	85	TRIM HALF ROUND ARCH FLAT SMOOTH
AR48X4M	85	TRIM HALF ROUND ARCH DECORATIVE SMOOTH
AR48X6F	86	TRIM HALF ROUND ARCH FLAT SMOOTH
AR48X6M	86	TRIM HALF ROUND ARCH DECORATIVE SMOOTH
AR60X6M	86	TRIM HALF ROUND ARCH DECORATIVE SMOOTH
AR64X10MC	86	TRIM HALF RND ARCH DECO W/END CAP SMOOTH
AR72X4F	85	TRIM HALF ROUND ARCH FLAT SMOOTH
AR72X6M	86	TRIM HALF ROUND ARCH DECORATIVE SMOOTH
B		
B10X13	272	NEWEL POST BALL SMOOTH
B12X16	209	FINIAL BALL SMOOTH
B3X5	209	FINIAL BALL SMOOTH
B4X6	209	FINIAL BALL SMOOTH
B5X7	272	NEWEL POST BALL SMOOTH
B6X8	209	FINIAL BALL SMOOTH
B6X9	209	FINIAL BALL SMOOTH
B7X9	209	FINIAL BALL SMOOTH
B8X10	209	FINIAL BALL SMOOTH
BAL2.5X15AY	267	BALUSTER ASHLEY SMOOTH
BAL2X24SQ	267	BALUSTER SQUARE SMOOTH
BAL2X28SQ	267	BALUSTER SQUARE SMOOTH

Part Number	Page	Description
BAL2X32SQ	267	BALUSTER SQUARE SMOOTH
BAL3X18WF	267	BALUSTER WOODRUFF SMOOTH
BAL3X20AY	267	BALUSTER ASHLEY SMOOTH
BAL3X20CC	267	BALUSTER CLASSIC SMOOTH
BAL3X20WF	267	BALUSTER WOODRUFF SMOOTH
BAL3X24AY	267	BALUSTER ASHLEY SMOOTH
BAL3X24CC	267	BALUSTER CLASSIC SMOOTH
BAL3X24LN	267	BALUSTER LOGAN SMOOTH
BAL3X24WF	267	BALUSTER WOODRUFF SMOOTH
BAL3X28AY	267	BALUSTER ASHLEY SMOOTH
BAL3X28CC	267	BALUSTER CLASSIC SMOOTH
BAL3X28LN	267	BALUSTER LOGAN SMOOTH
BAL3X28WF	267	BALUSTER WOODRUFF SMOOTH
BAL3X32AY	267	BALUSTER ASHLEY SMOOTH
BAL3X32CC	267	BALUSTER CLASSIC SMOOTH
BAL3X32WF	267	BALUSTER WOODRUFF SMOOTH
BAL3X36AY	267	BALUSTER ASHLEY SMOOTH
BAL4X22BE	269	BALUSTER BEAUMONT SMOOTH
BAL4X24AY	269	BALUSTER ASHLEY SMOOTH
BAL4X27CCOB	269	BALUSTER CLASSIC SMOOTH
BAL4X31CCOB	269	BALUSTER CLASSIC SMOOTH
BAL5X19BE	269	BALUSTER BEAUMONT SMOOTH
BAL5X20CC	269	BALUSTER CLASSIC SMOOTH
BAL5X20RL	269	BALUSTER ROSEDALE SMOOTH
BAL5X22BE	269	BALUSTER BEAUMONT SMOOTH
BAL5X24AY	269	BALUSTER ASHLEY SMOOTH
BAL5X24CC	269	BALUSTER CLASSIC SMOOTH

Part Number	Page	Description
BAL5X28CC	269	BALUSTER CLASSIC SMOOTH
BAL5X28CCOB	269	BALUSTER CLASSIC SMOOTH
BAL5X28WF	269	BALUSTER WOODRUFF SMOOTH
BAL5X30CC	269	BALUSTER CLASSIC SMOOTH
BAL5X32CC	269	BALUSTER CLASSIC SMOOTH
BBR5X144	266	BALUSTER STRAIGHT BOTTOM RAIL SMOOTH
BBR5X96	266	BALUSTER STRAIGHT BOTTOM RAIL SMOOTH
BBR7X120	268	BALUSTER STRAIGHT BOTTOM RAIL SMOOTH
BBR7X144	268	BALUSTER STRAIGHT BOTTOM RAIL SMOOTH
BBR7X96	268	BALUSTER STRAIGHT BOTTOM RAIL SMOOTH
BC10X15	154	BEAM CAP, TIMBER TEXTURE
BCSMT10X15	142	BEAM CAP SMOOTH
BKT10.5X20X6	174	BRACKET SMOOTH
BKT10X10X9	171	BRACKET SMOOTH
BKT10X11	171	BRACKET SMOOTH
BKT10X12	177	BRACKET SMOOTH
BKT10X12X4	172	BRACKET SMOOTH
BKT10X14	180	BRACKET SMOOTH
BKT10X16	175	BRACKET SMOOTH
BKT10X16X4	166	BRACKET SMOOTH
BKT10X16X6	174	BRACKET SMOOTH
BKT11X12X3	181	BRACKET SMOOTH
BKT11X15	174	BRACKET SMOOTH
BKT11X16	174	BRACKET SMOOTH
BKT11X16X6	180	BRACKET SMOOTH
BKT11X17	175	BRACKET SMOOTH
BKT11X20	167	BRACKET SMOOTH

Part Number	Page	Description
BKT11X20X6	180	BRACKET SMOOTH
BKT11X20X8	179	BRACKET SMOOTH
BKT11X30	177	BRACKET SMOOTH
BKT12X10	172	BRACKET SMOOTH
BKT12X12	176	BRACKET SMOOTH
BKT12X12GP	176	BRACKET SMOOTH
BKT12X12WW	177	BRACKET SMOOTH
BKT12X12X3	177	BRACKET SMOOTH
BKT12X12X4	166	BRACKET SMOOTH
BKT12X12X4CV	170	BRACKET SMOOTH
BKT12X12X4SC	187	BRACKET SMOOTH
BKT12X16	167	BRACKET SMOOTH
BKT12X17	175	BRACKET SMOOTH
BKT12X18X3X1S	190	BRACKET, TIMBER TEXTURE
BKT12X20X3S	191	BRACKET, TIMBER TEXTURE
BKT12X21X3	177	BRACKET SMOOTH
BKT12X24X3	168	BRACKET SMOOTH
BKT12X24X3S	194	BRACKET, TIMBER TEXTURE
BKT13X13X3	173	BRACKET SMOOTH
BKT13X15	181	BRACKET SMOOTH
BKT13X18X8S	192	BRACKET, TIMBER TEXTURE
BKT13X6	178	BRACKET SMOOTH
BKT14X14	181	BRACKET SMOOTH
BKT14X14X4	166	BRACKET SMOOTH
BKT14X15	177	BRACKET SMOOTH
BKT14X16	172	BRACKET SMOOTH
BKT14X16X3.5S	190	BRACKET, TIMBER TEXTURE

Part Number	Page	Description
BKT14X16X4	167	BRACKET SMOOTH
BKT14X16X6S	190	BRACKET, TIMBER TEXTURE
BKT14X26	180	BRACKET SMOOTH
BKT14X30X7.5S	192	BRACKET, TIMBER TEXTURE
BKT15X15	181	BRACKET SMOOTH
BKT15X18X6	168	BRACKET SMOOTH
BKT15X28	175	BRACKET SMOOTH
BKT16X16	166	BRACKET SMOOTH
BKT16X18X3	167	BRACKET SMOOTH
BKT16X18X4S	192	BRACKET, TIMBER TEXTURE
BKT16X23X3	177	BRACKET SMOOTH
BKT16X32X4S	192	BRACKET, TIMBER TEXTURE
BKT17X17	167	BRACKET SMOOTH
BKT18X10	172	BRACKET SMOOTH
BKT18X18X3X1S	190	BRACKET, TIMBER TEXTURE
BKT18X18X4	166	BRACKET SMOOTH
BKT18X18X4S	190	BRACKET, TIMBER TEXTURE
BKT18X24X3	173	BRACKET SMOOTH
BKT18X24X3X2S	191	BRACKET, TIMBER TEXTURE
BKT18X24X4	168	BRACKET SMOOTH
BKT18X30X4	168	BRACKET SMOOTH
BKT18X30X4S	190	BRACKET, TIMBER TEXTURE
BKT18X35	179	BRACKET SMOOTH
BKT18X9X3	172	BRACKET SMOOTH
BKT19X20	177	BRACKET SMOOTH
BKT19X24X4	169	BRACKET SMOOTH
BKT19X31	170	BRACKET SMOOTH

Part Number	Page	Description
BKT19X36X4	169	BRACKET SMOOTH
BKT20X24X5	169	BRACKET SMOOTH
BKT20X30X6	168	BRACKET SMOOTH
BKT22X21	177	BRACKET SMOOTH
BKT22X22	181	BRACKET SMOOTH
BKT22X24X4S-1	190	BRACKET, TIMBER TEXTURE
BKT22X24X6S	190	BRACKET, TIMBER TEXTURE
BKT22X26	173	BRACKET SMOOTH
BKT22X30	176	BRACKET SMOOTH
BKT22X30X6S	194	BRACKET, TIMBER TEXTURE
BKT22X30X8S	192	BRACKET, TIMBER TEXTURE
BKT23X26	179	BRACKET SMOOTH
BKT24X18X4S	191	BRACKET, TIMBER TEXTURE
BKT24X24X12	172	BRACKET SMOOTH
BKT24X24X5	176	BRACKET SMOOTH
BKT24X24X8CV	170	BRACKET SMOOTH
BKT24X36	170	BRACKET SMOOTH
BKT25X25	169	BRACKET SMOOTH
BKT25X27	168	BRACKET SMOOTH
BKT26X24X6S	190	BRACKET, TIMBER TEXTURE
BKT26X28	181	BRACKET SMOOTH
BKT28X30	169	BRACKET SMOOTH
BKT30X30	169	BRACKET SMOOTH
BKT30X30X8	181	BRACKET SMOOTH
BKT31X30X5	170	BRACKET SMOOTH
BKT32X31X5	202	TRELLIS OUTLOOKER SMOOTH
BKT32X31X5S	204	TRELLIS OUTLOOKER TIMBER TEXTURE

Part Number	Page	Description
BKT32X32	168	BRACKET SMOOTH
BKT36X36	169	BRACKET SMOOTH
BKT36X36X4	168	BRACKET SMOOTH
BKT36X36X6	168	BRACKET SMOOTH
BKT36X36X6S	190	BRACKET, TIMBER TEXTURE
BKT36X42	170	BRACKET SMOOTH
BKT40X40	168	BRACKET SMOOTH
BKT4X18X4	174	BRACKET SMOOTH
BKT5X10	174	BRACKET SMOOTH
BKT5X20	173	BRACKET SMOOTH
BKT5X4	178	BRACKET SMOOTH
BKT5X5X9	178	BRACKET SMOOTH
BKT5X8X6	174	BRACKET SMOOTH
BKT6X24	173	BRACKET SMOOTH
BKT6X24X6	174	BRACKET SMOOTH
BKT6X8	170	BRACKET SMOOTH
BKT7X11X3	171	BRACKET SMOOTH
BKT7X12X4	172	BRACKET SMOOTH
BKT7X16	180	BRACKET SMOOTH
BKT7X18	180	BRACKET SMOOTH
BKT7X6X12	178	BRACKET SMOOTH
BKT8X13	172	BRACKET SMOOTH
BKT8X15	174	BRACKET SMOOTH
BKT8X17	180	BRACKET SMOOTH
BKT8X29X4	181	BRACKET SMOOTH
BKT8X6	170	BRACKET SMOOTH
BKT8X7X18	178	BRACKET SMOOTH

Part Number	Page	Description
BKT8X8	170	BRACKET SMOOTH
BKT8X8X4	171	BRACKET SMOOTH
BKT8X9X14	178	BRACKET SMOOTH
BKT9X11	166	BRACKET SMOOTH
BKT9X13	174	BRACKET SMOOTH
BKTCV18X24X4S	194	BRACKET, TIMBER TEXTURE, COVE KNEE BRACE
BKTCV18X24X6S	194	BRACKET, TIMBER TEXTURE, COVE KNEE BRACE
BKTCV21X30X6S	194	BRACKET, TIMBER TEXTURE, COVE KNEE BRACE
BKTS18X24X6S	193	BRACKET, TIMBER TEXTURE, FLAT KNEE BRACE
BM4X5X192	145	BEAM CLASSIC SMOOTH
BMCDR8X6X168S	153	BEAM, TIMBER TEXTURE
BMCRT25X12X6S	201	BEAM, TIMBER TEXTURE, RAFTER TAIL
BMD4X8X144	202	TRELLIS BEAM SMOOTH
BMD4X8X144S	204	BEAM, TIMBER TEXTURE
BMD4X8X48	202	TRELLIS BEAM SMOOTH
BMD4X8X48S	204	BEAM, TIMBER TEXTURE
BMH10X12X120ELM	148	BEAM HAND HEWN, ELM
BMH10X12X144ELM	148	BEAM HAND HEWN, ELM
BMH10X12X168ELM	148	BEAM HAND HEWN, ELM
BMH10X12X192ELM	148	BEAM HAND HEWN, ELM
BMH10X12X216ELM	148	BEAM HAND HEWN, ELM
BMH10X12X240ELM	148	BEAM HAND HEWN, ELM
BMH10X12X264ELM	148	BEAM HAND HEWN, ELM
BMH10X12X288ELM	148	BEAM HAND HEWN, ELM
BMH10X12X96ELM	148	BEAM HAND HEWN, ELM
BMH4X6X120ELM	148	BEAM HAND HEWN, ELM
BMH4X6X144ELM	148	BEAM HAND HEWN, ELM

Part Number	Page	Description
BMH4X6X168ELM	148	BEAM HAND HEWN, ELM
BMH4X6X192ELM	148	BEAM HAND HEWN, ELM
BMH4X6X216ELM	148	BEAM HAND HEWN, ELM
BMH4X6X240ELM	148	BEAM HAND HEWN, ELM
BMH4X6X264ELM	148	BEAM HAND HEWN, ELM
BMH4X6X288ELM	148	BEAM HAND HEWN, ELM
BMH4X6X96ELM	148	BEAM HAND HEWN, ELM
BMH6X8X120ELM	148	BEAM HAND HEWN, ELM
BMH6X8X144ELM	148	BEAM HAND HEWN, ELM
BMH6X8X168ELM	148	BEAM HAND HEWN, ELM
BMH6X8X192ELM	148	BEAM HAND HEWN, ELM
BMH6X8X216ELM	148	BEAM HAND HEWN, ELM
BMH6X8X240ELM	148	BEAM HAND HEWN, ELM
BMH6X8X264ELM	148	BEAM HAND HEWN, ELM
BMH6X8X288ELM	148	BEAM HAND HEWN, ELM
BMH6X8X60ELM-EC	140	BEAM MANTEL HAND HEWN
BMH6X8X66ELM-EC	140	BEAM MANTEL HAND HEWN
BMH6X8X72ELM-EC	140	BEAM MANTEL HAND HEWN
BMH6X8X78ELM-EC	140	BEAM MANTEL HAND HEWN
BMH6X8X84ELM-EC	140	BEAM MANTEL HAND HEWN
BMH6X8X90ELM-EC	140	BEAM MANTEL HAND HEWN
BMH6X8X96ELM	148	BEAM HAND HEWN, ELM
BMH8X10X120ELM	148	BEAM HAND HEWN, ELM
BMH8X10X144ELM	148	BEAM HAND HEWN, ELM
BMH8X10X168ELM	148	BEAM HAND HEWN, ELM
BMH8X10X192ELM	148	BEAM HAND HEWN, ELM
BMH8X10X216ELM	148	BEAM HAND HEWN, ELM

Part Number	Page	Description
BMH8X10X240ELM	148	BEAM HAND HEWN, ELM
BMH8X10X264ELM	148	BEAM HAND HEWN, ELM
BMH8X10X288ELM	148	BEAM HAND HEWN, ELM
BMH8X10X60ELM-EC	140	BEAM MANTEL HAND HEWN
BMH8X10X66ELM-EC	140	BEAM MANTEL HAND HEWN
BMH8X10X72ELM-EC	140	BEAM MANTEL HAND HEWN
BMH8X10X78ELM-EC	140	BEAM MANTEL HAND HEWN
BMH8X10X84ELM-EC	140	BEAM MANTEL HAND HEWN
BMH8X10X90ELM-EC	140	BEAM MANTEL HAND HEWN
BMH8X10X96ELM	148	BEAM HAND HEWN, ELM
BMM10X12X120RDW	150	BEAM MESA, REDWOOD
BMM10X12X144RDW	150	BEAM MESA, REDWOOD
BMM10X12X168RDW	150	BEAM MESA, REDWOOD
BMM10X12X192RDW	150	BEAM MESA, REDWOOD
BMM10X12X216RDW	150	BEAM MESA, REDWOOD
BMM10X12X240RDW	150	BEAM MESA, REDWOOD
BMM10X12X264RDW	150	BEAM MESA, REDWOOD
BMM10X12X288RDW	150	BEAM MESA, REDWOOD
BMM10X12X96RDW	150	BEAM MESA, REDWOOD
BMM10X15X234RDW	150	BEAM MESA, REDWOOD
BMM4X6X120RDW	150	BEAM MESA, REDWOOD
BMM4X6X144RDW	150	BEAM MESA, REDWOOD
BMM4X6X168RDW	150	BEAM MESA, REDWOOD
BMM4X6X192RDW	150	BEAM MESA, REDWOOD
BMM4X6X216RDW	150	BEAM MESA, REDWOOD
BMM4X6X240RDW	150	BEAM MESA, REDWOOD
BMM4X6X264RDW	150	BEAM MESA, REDWOOD

Part Number	Page	Description
BMM4X6X288RDW	150	BEAM MESA, REDWOOD
BMM4X6X96RDW	150	BEAM MESA, REDWOOD
BMM6X8X120RDW	150	BEAM MESA, REDWOOD
BMM6X8X144RDW	150	BEAM MESA, REDWOOD
BMM6X8X168RDW	150	BEAM MESA, REDWOOD
BMM6X8X192RDW	150	BEAM MESA, REDWOOD
BMM6X8X216RDW	150	BEAM MESA, REDWOOD
BMM6X8X240RDW	150	BEAM MESA, REDWOOD
BMM6X8X264RDW	150	BEAM MESA, REDWOOD
BMM6X8X288RDW	150	BEAM MESA, REDWOOD
BMM6X8X96RDW	150	BEAM MESA, REDWOOD
BMM8X10X120RDW	150	BEAM MESA, REDWOOD
BMM8X10X144RDW	150	BEAM MESA, REDWOOD
BMM8X10X168RDW	150	BEAM MESA, REDWOOD
BMM8X10X192RDW	150	BEAM MESA, REDWOOD
BMM8X10X216RDW	150	BEAM MESA, REDWOOD
BMM8X10X240RDW	150	BEAM MESA, REDWOOD
BMM8X10X264RDW	150	BEAM MESA, REDWOOD
BMM8X10X288RDW	150	BEAM MESA, REDWOOD
BMM8X10X96RDW	150	BEAM MESA, REDWOOD
BMPH15X20	155	BEAM PLATE HAMMERED
BMPH8X10	155	BEAM PLATE HAMMERED
BMPTS8X10	155	BEAM PLATE SMOOTH
BMR10X12X120CDR	146	BEAM ROUGH SAWN, WESTERN RED CEDAR
BMR10X12X144CDR	146	BEAM ROUGH SAWN, WESTERN RED CEDAR
BMR10X12X168CDR	146	BEAM ROUGH SAWN, WESTERN RED CEDAR
BMR10X12X192CDR	146	BEAM ROUGH SAWN, WESTERN RED CEDAR

Part Number	Page	Description
BMR10X12X216CDR	146	BEAM ROUGH SAWN, WESTERN RED CEDAR
BMR10X12X240CDR	146	BEAM ROUGH SAWN, WESTERN RED CEDAR
BMR10X12X264CDR	146	BEAM ROUGH SAWN, WESTERN RED CEDAR
BMR10X12X288CDR	146	BEAM ROUGH SAWN, WESTERN RED CEDAR
BMR10X12X96CDR	146	BEAM ROUGH SAWN, WESTERN RED CEDAR
BMR4X6X120CDR	146	BEAM ROUGH SAWN, WESTERN RED CEDAR
BMR4X6X144CDR	146	BEAM ROUGH SAWN, WESTERN RED CEDAR
BMR4X6X168CDR	146	BEAM ROUGH SAWN, WESTERN RED CEDAR
BMR4X6X192CDR	146	BEAM ROUGH SAWN, WESTERN RED CEDAR
BMR4X6X216CDR	146	BEAM ROUGH SAWN, WESTERN RED CEDAR
BMR4X6X240CDR	146	BEAM ROUGH SAWN, WESTERN RED CEDAR
BMR4X6X264CDR	146	BEAM ROUGH SAWN, WESTERN RED CEDAR
BMR4X6X288CDR	146	BEAM ROUGH SAWN, WESTERN RED CEDAR
BMR4X6X96CDR	146	BEAM ROUGH SAWN, WESTERN RED CEDAR
BMR6X8X120CDR	146	BEAM ROUGH SAWN, WESTERN RED CEDAR
BMR6X8X144CDR	146	BEAM ROUGH SAWN, WESTERN RED CEDAR
BMR6X8X168CDR	146	BEAM ROUGH SAWN, WESTERN RED CEDAR
BMR6X8X192CDR	146	BEAM ROUGH SAWN, WESTERN RED CEDAR
BMR6X8X216CDR	146	BEAM ROUGH SAWN, WESTERN RED CEDAR
BMR6X8X240CDR	146	BEAM ROUGH SAWN, WESTERN RED CEDAR
BMR6X8X264CDR	146	BEAM ROUGH SAWN, WESTERN RED CEDAR
BMR6X8X288CDR	146	BEAM ROUGH SAWN, WESTERN RED CEDAR
BMR6X8X60CDR-EC	138	BEAM MANTEL ROUGH SAWN
BMR6X8X66CDR-EC	138	BEAM MANTEL ROUGH SAWN
BMR6X8X72CDR-EC	138	BEAM MANTEL ROUGH SAWN
BMR6X8X78CDR-EC	138	BEAM MANTEL ROUGH SAWN
BMR6X8X84CDR-EC	138	BEAM MANTEL ROUGH SAWN

Part Number	Page	Description
BMR6X8X90CDR-EC	138	BEAM MANTEL ROUGH SAWN
BMR6X8X96CDR	146	BEAM ROUGH SAWN, WESTERN RED CEDAR
BMR8X10X120CDR	146	BEAM ROUGH SAWN, WESTERN RED CEDAR
BMR8X10X144CDR	146	BEAM ROUGH SAWN, WESTERN RED CEDAR
BMR8X10X168CDR	146	BEAM ROUGH SAWN, WESTERN RED CEDAR
BMR8X10X192CDR	146	BEAM ROUGH SAWN, WESTERN RED CEDAR
BMR8X10X216CDR	146	BEAM ROUGH SAWN, WESTERN RED CEDAR
BMR8X10X240CDR	146	BEAM ROUGH SAWN, WESTERN RED CEDAR
BMR8X10X264CDR	146	BEAM ROUGH SAWN, WESTERN RED CEDAR
BMR8X10X288CDR	146	BEAM ROUGH SAWN, WESTERN RED CEDAR
BMR8X10X60CDR-EC	138	BEAM MANTEL ROUGH SAWN
BMR8X10X66CDR-EC	138	BEAM MANTEL ROUGH SAWN
BMR8X10X72CDR-EC	138	BEAM MANTEL ROUGH SAWN
BMR8X10X78CDR-EC	138	BEAM MANTEL ROUGH SAWN
BMR8X10X84CDR-EC	138	BEAM MANTEL ROUGH SAWN
BMR8X10X90CDR-EC	138	BEAM MANTEL ROUGH SAWN
BMR8X10X96CDR	146	BEAM ROUGH SAWN, WESTERN RED CEDAR
BMRTBL4X6X12RS-4PK	200	BEAM RAFTER TAIL, ROUGH SAWN, BULL NOSE
BMRTBL4X6X18RS-4PK	200	BEAM RAFTER TAIL, ROUGH SAWN, BULL NOSE
BMRTBL4X6X24RS-4PK	200	BEAM RAFTER TAIL, ROUGH SAWN, BULL NOSE
BMRTBL4X6X30RS-4PK	200	BEAM RAFTER TAIL, ROUGH SAWN, BULL NOSE
BMRTBL4X6X36RS-4PK	200	BEAM RAFTER TAIL, ROUGH SAWN, BULL NOSE
BMRTBL4X6X42RS-4PK	200	BEAM RAFTER TAIL, ROUGH SAWN, BULL NOSE
BMRTBL4X8X18RS-4PK	200	BEAM RAFTER TAIL, ROUGH SAWN, BULL NOSE
BMRTBL4X8X24RS-4PK	200	BEAM RAFTER TAIL, ROUGH SAWN, BULL NOSE
BMRTBL4X8X30RS-4PK	200	BEAM RAFTER TAIL, ROUGH SAWN, BULL NOSE
BMRTBL4X8X36RS-4PK	200	BEAM RAFTER TAIL, ROUGH SAWN, BULL NOSE

Part Number	Page	Description
BMRTBL4X8X42RS-4PK	200	BEAM RAFTER TAIL, ROUGH SAWN, BULL NOSE
BMRTCV4X6X18RS-4PK	200	BEAM RAFTER TAIL, ROUGH SAWN, COVE
BMRTCV4X6X24RS-4PK	200	BEAM RAFTER TAIL, ROUGH SAWN, COVE
BMRTCV4X6X30RS-4PK	200	BEAM RAFTER TAIL, ROUGH SAWN, COVE
BMRTCV4X6X36RS-4PK	200	BEAM RAFTER TAIL, ROUGH SAWN, COVE
BMRTCV4X6X42RS-4PK	200	BEAM RAFTER TAIL, ROUGH SAWN, COVE
BMRTCV4X8X18RS-4PK	200	BEAM RAFTER TAIL, ROUGH SAWN, COVE
BMRTCV4X8X24RS-4PK	200	BEAM RAFTER TAIL, ROUGH SAWN, COVE
BMRTCV4X8X30RS-4PK	200	BEAM RAFTER TAIL, ROUGH SAWN, COVE
BMRTCV4X8X36RS-4PK	200	BEAM RAFTER TAIL, ROUGH SAWN, COVE
BMRTCV4X8X42RS-4PK	200	BEAM RAFTER TAIL, ROUGH SAWN, COVE
BMRTS6X4X24S	201	BEAM RAFTER TAIL, TIMBER TEXTURE
BMRTS8X4X24S	201	BEAM RAFTER TAIL, TIMBER TEXTURE
BMRTSC4X6X12RS-4PK	200	BEAM RAFTER TAIL, ROUGH SAWN, SCROLL
BMRTSC4X6X18RS-4PK	200	BEAM RAFTER TAIL, ROUGH SAWN, SCROLL
BMRTSC4X6X24RS-4PK	200	BEAM RAFTER TAIL, ROUGH SAWN, SCROLL
BMRTSC4X6X30RS-4PK	200	BEAM RAFTER TAIL, ROUGH SAWN, SCROLL
BMRTSC4X6X36RS-4PK	200	BEAM RAFTER TAIL, ROUGH SAWN, SCROLL
BMRTSC4X6X42RS-4PK	200	BEAM RAFTER TAIL, ROUGH SAWN, SCROLL
BMRTSC4X8X18RS-4PK	200	BEAM RAFTER TAIL, ROUGH SAWN, SCROLL
BMRTSC4X8X24RS-4PK	200	BEAM RAFTER TAIL, ROUGH SAWN, SCROLL
BMRTSC4X8X36RS-4PK	200	BEAM RAFTER TAIL, ROUGH SAWN, SCROLL
BMRTSC4X8X42RS-4PK	200	BEAM RAFTER TAIL, ROUGH SAWN, SCROLL
BMRTSL4X6X12RS-4PK	200	BEAM RAFTER TAIL, ROUGH SAWN, SLANT
BMRTSL4X6X24RS-4PK	200	BEAM RAFTER TAIL, ROUGH SAWN, SLANT
BMRTSL4X6X30RS-4PK	200	BEAM RAFTER TAIL, ROUGH SAWN, SLANT
BMRTSL4X6X36RS-4PK	200	BEAM RAFTER TAIL, ROUGH SAWN, SLANT

Part Number	Page	Description
BMRTSL4X6X42RS-4PK	200	BEAM RAFTER TAIL, ROUGH SAWN, SLANT
BMRTSL4X8X18RS-4PK	200	BEAM RAFTER TAIL, ROUGH SAWN, SLANT
BMRTSL4X8X24RS-4PK	200	BEAM RAFTER TAIL, ROUGH SAWN, SLANT
BMRTSL4X8X30RS-4PK	200	BEAM RAFTER TAIL, ROUGH SAWN, SLANT
BMRTSL4X8X36RS-4PK	200	BEAM RAFTER TAIL, ROUGH SAWN, SLANT
BMRTSL4X8X42RS-4PK	200	BEAM RAFTER TAIL, ROUGH SAWN, SLANT
BMRTST4X6X12RS-4PK	200	BEAM RAFTER TAIL, ROUGH SAWN, STRAIGHT
BMRTST4X6X18RS-4PK	200	BEAM RAFTER TAIL, ROUGH SAWN, STRAIGHT
BMRTST4X6X24RS-4PK	200	BEAM RAFTER TAIL, ROUGH SAWN, STRAIGHT
BMRTST4X6X30RS-4PK	200	BEAM RAFTER TAIL, ROUGH SAWN, STRAIGHT
BMRTST4X6X36RS-4PK	200	BEAM RAFTER TAIL, ROUGH SAWN, STRAIGHT
BMRTST4X6X42RS-4PK	200	BEAM RAFTER TAIL, ROUGH SAWN, STRAIGHT
BMRTST4X8X18RS-4PK	200	BEAM RAFTER TAIL, ROUGH SAWN, STRAIGHT
BMRTST4X8X24RS-4PK	200	BEAM RAFTER TAIL, ROUGH SAWN, STRAIGHT
BMRTST4X8X30RS-4PK	200	BEAM RAFTER TAIL, ROUGH SAWN, STRAIGHT
BMRTST4X8X36RS-4PK	200	BEAM RAFTER TAIL, ROUGH SAWN, STRAIGHT
BMRTST4X8X42RS-4PK	200	BEAM RAFTER TAIL, ROUGH SAWN, STRAIGHT
BMSMT10X12X120	142	BEAM SMOOTH
BMSMT10X12X144	142	BEAM SMOOTH
BMSMT10X12X168	142	BEAM SMOOTH
BMSMT10X12X192	142	BEAM SMOOTH
BMSMT10X12X216	142	BEAM SMOOTH
BMSMT10X12X240	142	BEAM SMOOTH
BMSMT10X12X96	142	BEAM SMOOTH
BMSMT4X4X120	142	BEAM SMOOTH
BMSMT4X4X144	142	BEAM SMOOTH
BMSMT4X4X168	142	BEAM SMOOTH

Part Number	Page	Description
BMSMT4X4X192	142	BEAM SMOOTH
BMSMT4X4X216	142	BEAM SMOOTH
BMSMT4X4X240	142	BEAM SMOOTH
BMSMT4X4X96	142	BEAM SMOOTH
BMSMT4X6X120	142	BEAM SMOOTH
BMSMT4X6X144	142	BEAM SMOOTH
BMSMT4X6X168	142	BEAM SMOOTH
BMSMT4X6X192	142	BEAM SMOOTH
BMSMT4X6X216	142	BEAM SMOOTH
BMSMT4X6X240	142	BEAM SMOOTH
BMSMT4X6X96	142	BEAM SMOOTH
BMSMT6X8X120	142	BEAM SMOOTH
BMSMT6X8X144	142	BEAM SMOOTH
BMSMT6X8X168	142	BEAM SMOOTH
BMSMT6X8X192	142	BEAM SMOOTH
BMSMT6X8X216	142	BEAM SMOOTH
BMSMT6X8X240	142	BEAM SMOOTH
BMSMT6X8X60-EC	132	BEAM SMOOTH END CAPS
BMSMT6X8X66-EC	132	BEAM SMOOTH END CAPS
BMSMT6X8X72-EC	132	BEAM SMOOTH END CAPS
BMSMT6X8X78-EC	132	BEAM SMOOTH END CAPS
BMSMT6X8X84-EC	132	BEAM SMOOTH END CAPS
BMSMT6X8X90-EC	132	BEAM SMOOTH END CAPS
BMSMT6X8X96	142	BEAM SMOOTH
BMSMT8X10X120	142	BEAM SMOOTH
BMSMT8X10X144	142	BEAM SMOOTH
BMSMT8X10X168	142	BEAM SMOOTH

Part Number	Page	Description
BMSMT8X10X192	142	BEAM SMOOTH
BMSMT8X10X216	142	BEAM SMOOTH
BMSMT8X10X240	142	BEAM SMOOTH
BMSMT8X10X60-EC	132	BEAM SMOOTH END CAPS
BMSMT8X10X66-EC	132	BEAM SMOOTH END CAPS
BMSMT8X10X72-EC	132	BEAM SMOOTH END CAPS
BMSMT8X10X78-EC	132	BEAM SMOOTH END CAPS
BMSMT8X10X84-EC	132	BEAM SMOOTH END CAPS
BMSMT8X10X90-EC	132	BEAM SMOOTH END CAPS
BMSMT8X10X96	142	BEAM SMOOTH
BMSTRPH10X12	154	BEAM STRAP HAMMERED
BMSTRPH10X15	154	BEAM STRAP HAMMERED
BMSTRPH4X6	154	BEAM STRAP HAMMERED
BMSTRPH6X8	154	BEAM STRAP HAMMERED
BMSTRPH8X10	154	BEAM STRAP HAMMERED
BMSTRPS10X12	154	BEAM STRAP SMOOTH
BMSTRPS10X15	154	BEAM STRAP SMOOTH
BMSTRPS4X6	154	BEAM STRAP SMOOTH
BMSTRPS6X8	154	BEAM STRAP SMOOTH
BMSTRPS8X10	154	BEAM STRAP SMOOTH
BMT10X12X120CDR	152	BEAM TAHOE, WESTERN RED CEDAR
BMT10X12X144CDR	152	BEAM TAHOE, WESTERN RED CEDAR
BMT10X12X168CDR	152	BEAM TAHOE, WESTERN RED CEDAR
BMT10X12X192CDR	152	BEAM TAHOE, WESTERN RED CEDAR
BMT10X12X216CDR	152	BEAM TAHOE, WESTERN RED CEDAR
BMT10X12X240CDR	152	BEAM TAHOE, WESTERN RED CEDAR
BMT10X12X264CDR	152	BEAM TAHOE, WESTERN RED CEDAR

Part Number	Page	Description
BMT10X12X288CDR	152	BEAM TAHOE, WESTERN RED CEDAR
BMT10X12X96CDR	152	BEAM TAHOE, WESTERN RED CEDAR
BMT4X6X120CDR	152	BEAM TAHOE, WESTERN RED CEDAR
BMT4X6X144CDR	152	BEAM TAHOE, WESTERN RED CEDAR
BMT4X6X168CDR	152	BEAM TAHOE, WESTERN RED CEDAR
BMT4X6X192CDR	152	BEAM TAHOE, WESTERN RED CEDAR
BMT4X6X216CDR	152	BEAM TAHOE, WESTERN RED CEDAR
BMT4X6X240CDR	152	BEAM TAHOE, WESTERN RED CEDAR
BMT4X6X264CDR	152	BEAM TAHOE, WESTERN RED CEDAR
BMT4X6X288CDR	152	BEAM TAHOE, WESTERN RED CEDAR
BMT4X6X96CDR	152	BEAM TAHOE, WESTERN RED CEDAR
BMT6X8X120CDR	152	BEAM TAHOE, WESTERN RED CEDAR
BMT6X8X144CDR	152	BEAM TAHOE, WESTERN RED CEDAR
BMT6X8X168CDR	152	BEAM TAHOE, WESTERN RED CEDAR
BMT6X8X192CDR	152	BEAM TAHOE, WESTERN RED CEDAR
BMT6X8X216CDR	152	BEAM TAHOE, WESTERN RED CEDAR
BMT6X8X240CDR	152	BEAM TAHOE, WESTERN RED CEDAR
BMT6X8X264CDR	152	BEAM TAHOE, WESTERN RED CEDAR
BMT6X8X288CDR	152	BEAM TAHOE, WESTERN RED CEDAR
BMT6X8X96CDR	152	BEAM TAHOE, WESTERN RED CEDAR
BMT8X10X120CDR	152	BEAM TAHOE, WESTERN RED CEDAR
BMT8X10X144CDR	152	BEAM TAHOE, WESTERN RED CEDAR
BMT8X10X168CDR	152	BEAM TAHOE, WESTERN RED CEDAR
BMT8X10X192CDR	152	BEAM TAHOE, WESTERN RED CEDAR
BMT8X10X216CDR	152	BEAM TAHOE, WESTERN RED CEDAR
BMT8X10X240CDR	152	BEAM TAHOE, WESTERN RED CEDAR
BMT8X10X264CDR	152	BEAM TAHOE, WESTERN RED CEDAR

Part Number	Page	Description
BMT8X10X288CDR	152	BEAM TAHOE, WESTERN RED CEDAR
BMT8X10X96CDR	152	BEAM TAHOE, WESTERN RED CEDAR
BRK5	266	BALUSTER RAIL INSTALL KIT
BRK6-7	268	BALUSTER RAIL INSTALL KIT
BTM6X144	154	BEAM TOP MESA
BTM8X144	154	BEAM TOP MESA
BTR5X144	266	BALUSTER STRAIGHT TOP RAIL SMOOTH
BTR5X96	266	BALUSTER STRAIGHT TOP RAIL SMOOTH
BTR7X120	268	BALUSTER STRAIGHT TOP RAIL SMOOTH
BTR7X144	268	BALUSTER STRAIGHT TOP RAIL SMOOTH
BTR7X96	268	BALUSTER STRAIGHT TOP RAIL SMOOTH

C

CAP47E	74	PEDIMENT COMBO ECO ACORN SMOOTH
CAP50	74	PEDIMENT COMBO ACORN SMOOTH
CAP54	74	PEDIMENT COMBO ACORN SMOOTH
CAP54BT	74	PEDIMENT COMBO ACORN W/BT SMOOTH
CAP58	74	PEDIMENT COMBO ACORN SMOOTH
CAP58BT	74	PEDIMENT COMBO ACORN W/BT SMOOTH
CAP67	74	PEDIMENT COMBO ACORN SMOOTH
CAP67BT	74	PEDIMENT COMBO ACORN W/BT SMOOTH
CAP75	74	PEDIMENT COMBO ACORN SMOOTH
CAP75BT	74	PEDIMENT COMBO ACORN W/BT SMOOTH
CAP80	74	PEDIMENT COMBO ACORN SMOOTH
CAP80BT	74	PEDIMENT COMBO ACORN W/BT SMOOTH
CAP85	74	PEDIMENT COMBO ACORN SMOOTH
CAP85BT	74	PEDIMENT COMBO ACORN W/BT SMOOTH
CCP37	73	PEDIMENT COMBO PEAKED CAP SMOOTH

Part Number	Page	Description
CHC1X6	57	DISTINCTION CROSSHEAD END CAP
CHC1X9	57	DISTINCTION CROSSHEAD END CAP
CHC2X6	57	DISTINCTION CROSSHEAD END CAP
CHC2X6-5	57	DISTINCTION CROSSHEAD END CAP
CHC2X9-5	57	DISTINCTION CROSSHEAD END CAP
CHC4X6-5	57	DISTINCTION CROSSHEAD END CAP
CHC7X6	57	DISTINCTION CROSSHEAD END CAP
CHC7X6-5	57	DISTINCTION CROSSHEAD END CAP
CHC7X9	57	DISTINCTION CROSSHEAD END CAP
CHC7X9-5	57	DISTINCTION CROSSHEAD END CAP
CHCCC4X9BT-5	55	CRAFTSMAN COVE CROSSHEAD END CAPS
CHCCC6X9BT-5	55	CRAFTSMAN COVE CROSSHEAD END CAPS
CHCCT144X9BT	55	TRIMMABLE CRAFTSMAN COVE CROSSHEAD
CHCCT216X9BT	55	TRIMMABLE CRAFTSMAN COVE CROSSHEAD
CHCCT36X9BT	55	TRIMMABLE CRAFTSMAN COVE CROSSHEAD
CHCCT48X9BT	55	TRIMMABLE CRAFTSMAN COVE CROSSHEAD
CHCST144X6	59	CRAFTSMAN STEP CROSSHEAD
CHCST144X8	59	CRAFTSMAN STEP CROSSHEAD
CHCST216X6	59	CRAFTSMAN STEP CROSSHEAD
CHCST216X8	59	CRAFTSMAN STEP CROSSHEAD
CHCST36X6	59	CRAFTSMAN STEP CROSSHEAD
CHCST36X8	59	CRAFTSMAN STEP CROSSHEAD
CHCST48X6	59	CRAFTSMAN STEP CROSSHEAD
CHCST48X8	59	CRAFTSMAN STEP CROSSHEAD
CHT144X6	57	TRIMMABLE CROSSHEAD
CHT144X9	57	TRIMMABLE CROSSHEAD
CHT216X6	57	TRIMMABLE CROSSHEAD

Part Number	Page	Description
CHT216X9	57	TRIMMABLE CROSSHEAD
CHT36X6	57	TRIMMABLE CROSSHEAD
CHT36X9	57	TRIMMABLE CROSSHEAD
CHT48X6	57	TRIMMABLE CROSSHEAD
CHT48X9	57	TRIMMABLE CROSSHEAD
CIR24X4F	87	TRIM CIRCLE SMOOTH
CIR36X4F	87	TRIM CIRCLE SMOOTH
CLV12X24	214	CATHEDRAL LOUVER DECO SMOOTH
CLV14X22	214	CATHEDRAL LOUVER DECO SMOOTH
CLV16X36	214	CATHEDRAL LOUVER DECO SMOOTH
CLV18X24	214	CATHEDRAL LOUVER DECO SMOOTH
CLV18X30	214	CATHEDRAL LOUVER DECO SMOOTH
CLV18X30X4F	214	TRIM CATHEDRAL LOUVER SMOOTH
CLV22X31	214	CATHEDRAL LOUVER DECO SMOOTH
CLV22X31X4F	214	TRIM CATHEDRAL LOUVER SMOOTH
CLV24X48	214	CATHEDRAL LOUVER DECO SMOOTH
CLV28X43	214	CATHEDRAL LOUVER DECO SMOOTH
CLV36X48	214	CATHEDRAL LOUVER DECO SMOOTH
CN6X6	206	COVER VENT
COL11X108PSQ	275	COLUMN SQUARE PLAIN SMOOTH
COL11X96PSQ	275	COLUMN SQUARE PLAIN SMOOTH
COL8X96PSQ	275	COLUMN SQUARE PLAIN SMOOTH
COR11X11X5S	195	CORBEL, TIMBER TEXTURE
COR11X13X6S	197	CORBEL, TIMBER TEXTURE
COR12X18X6S	198	CORBEL, TIMBER TEXTURE
COR14X12X6S	197	CORBEL, TIMBER TEXTURE
COR16X10X8S	197	CORBEL, TIMBER TEXTURE

Part Number	Page	Description
COR16X7X3S	198	CORBEL, TIMBER TEXTURE
COR16X8S	199	CORBEL, TIMBER TEXTURE
COR18X8X6S	199	CORBEL, TIMBER TEXTURE
COR18X9X3S	199	CORBEL, TIMBER TEXTURE
COR24X5X5S	198	CORBEL, TIMBER TEXTURE
COR24X8X4S	199	CORBEL, TIMBER TEXTURE
COR24X8X6S	195	CORBEL, TIMBER TEXTURE
COR39X10X5.5S	197	CORBEL, TIMBER TEXTURE
COR5X5S	195	CORBEL, TIMBER TEXTURE
COR5X5X3S	195	CORBEL, TIMBER TEXTURE
COR7X11S	196	CORBEL, TIMBER TEXTURE
COR7X13X7S	195	CORBEL, TIMBER TEXTURE
COR7X15X4S	198	CORBEL, TIMBER TEXTURE
COR8X8X6S	195	CORBEL, TIMBER TEXTURE
CORCV18X12X6S	195	CORBEL, TIMBER TEXTURE, COVE
CORCV18X6X6S	195	CORBEL, TIMBER TEXTURE, COVE
CORCV18X8X4S	195	CORBEL, TIMBER TEXTURE, COVE
CORCV18X8X6S	195	CORBEL, TIMBER TEXTURE, COVE
COROG15X7S	196	CORBEL, TIMBER TEXTURE
COROG20X7S	196	CORBEL, TIMBER TEXTURE, OGEE
COROG24X6S	196	CORBEL, TIMBER TEXTURE, OGEE
COROG8X12S	196	CORBEL, TIMBER TEXTURE, OGEE
COROGA15X7S	196	CORBEL, TIMBER TEXTURE
COROGD15X7S	196	CORBEL, TIMBER TEXTURE
CPCP48	73	PEDIMENT COMBO PEAKED CAP SMOOTH
CPCP48BT	73	PEDIMENT COMBO PEAKED W/BT SMOOTH
CPCP50	73	PEDIMENT COMBO PEAKED CAP SMOOTH

Part Number	Page	Description
CPCP50BT	73	PEDIMENT COMBO PEAKED CAP W/BT SMOOTH
CPCP54	73	PEDIMENT COMBO PEAKED CAP SMOOTH
CPCP54BT	73	PEDIMENT COMBO PEAKED W/BT SMOOTH
CPCP58	73	PEDIMENT COMBO PEAKED CAP SMOOTH
CPCP67	73	PEDIMENT COMBO PEAKED CAP SMOOTH
CPCP67BT	73	PEDIMENT COMBO PEAKED CAP W/BT SMOOTH
CPCP75	73	PEDIMENT COMBO PEAKED CAP SMOOTH
CPCP75BT	73	PEDIMENT COMBO PEAKED CAP W/BT SMOOTH
CPCP80	73	PEDIMENT COMBO PEAKED CAP SMOOTH
CPCP80BT	73	PEDIMENT COMBO PEAKED W/BT SMOOTH
CPCP85	73	PEDIMENT COMBO PEAKED CAP SMOOTH
CRHP54	77	PEDIMENT COMBO RAMS HEAD SMOOTH
CRHP54BT	77	PEDIMENT COMBO RAMS HEAD W/BT SMOOTH
CRHP85	77	PEDIMENT COMBO RAMS HEAD SMOOTH
CSAP36	70	PEDIMENT COMBO SGMT ARCH SMOOTH
CSAP48	70	PEDIMENT COMBO SGMT ARCH SMOOTH
CSAP65	70	PEDIMENT COMBO SGMT ARCH SMOOTH
CSP54	70	PEDIMENT COMBO SUNBURST SMOOTH
CSP80	70	PEDIMENT COMBO SUNBURST SMOOTH
CSP85	70	PEDIMENT COMBO SUNBURST SMOOTH
CW10NM	238	COLUMN WRAP CAP BASE NECK MOULD
CW12NM	238	COLUMN WRAP CAP BASE NECK MOULD
CW17NM	243	COLUMN WRAP CAP BASE NECK MOULD
CW6NM	238	COLUMN WRAP CAP BASE NECK MOULD
CW8NM	238	COLUMN WRAP CAP BASE NECK MOULD
CWCB10CF	238	COLUMN WRAP CAP BASE CRAFTSMAN
CWCB10GK	238	COLUMN WRAP CAP BASE GREEK

Part Number	Page	Description
CWCB10PL	238	COLUMN WRAP CAP BASE PLAIN
CWCB10RO	238	COLUMN WRAP CAP BASE ROMAN
CWCB10TR	238	COLUMN WRAP CAP BASE TRADITIONAL
CWCB10TS	238	COLUMN WRAP CAP BASE TUSCAN
CWCB11X16CF	243	COLUMN WRAP CAP BASE CRAFTSMAN
CWCB11X16GK	243	COLUMN WRAP CAP BASE GREEK
CWCB11X16RO	243	COLUMN WRAP CAP BASE ROMAN
CWCB11X16TS	243	COLUMN WRAP CAP BASE TUSCAN
CWCB12CF	238	COLUMN WRAP CAP BASE CRAFTSMAN
CWCB12GK	238	COLUMN WRAP CAP BASE GREEK
CWCB12PL	238	COLUMN WRAP CAP BASE PLAIN
CWCB12RO	238	COLUMN WRAP CAP BASE ROMAN
CWCB12TR	238	COLUMN WRAP CAP BASE TRADITIONAL
CWCB12TS	238	COLUMN WRAP CAP BASE TUSCAN
CWCB13X20CF	243	COLUMN WRAP CAP BASE CRAFTSMAN
CWCB13X20GK	243	COLUMN WRAP CAP BASE GREEK
CWCB13X20RO	243	COLUMN WRAP CAP BASE ROMAN
CWCB13X20TS	243	COLUMN WRAP CAP BASE TUSCAN
CWCB16X24CF	243	COLUMN WRAP CAP BASE CRAFTSMAN
CWCB16X24GK	243	COLUMN WRAP CAP BASE GREEK
CWCB16X24RO	243	COLUMN WRAP CAP BASE ROMAN
CWCB16X24TS	243	COLUMN WRAP CAP BASE TUSCAN
CWCB6CF	238	COLUMN WRAP CAP BASE CRAFTSMAN
CWCB6GK	238	COLUMN WRAP CAP BASE GREEK
CWCB6PL	238	COLUMN WRAP CAP BASE PLAIN
CWCB6RO	238	COLUMN WRAP CAP BASE ROMAN
CWCB6TR	238	COLUMN WRAP CAP BASE TRADITIONAL

Part Number	Page	Description
CWCB6TS	238	COLUMN WRAP CAP BASE TUSCAN
CWCB8CF	238	COLUMN WRAP CAP BASE CRAFTSMAN
CWCB8GK	238	COLUMN WRAP CAP BASE GREEK
CWCB8PL	238	COLUMN WRAP CAP BASE PLAIN
CWCB8RO	238	COLUMN WRAP CAP BASE ROMAN
CWCB8TR	238	COLUMN WRAP CAP BASE TRADITIONAL
CWCB8TS	238	COLUMN WRAP CAP BASE TUSCAN
CWCB8X12CF	243	COLUMN WRAP CAP BASE CRAFTSMAN
CWCB8X12GK	243	COLUMN WRAP CAP BASE GREEK
CWCB8X12RO	243	COLUMN WRAP CAP BASE ROMAN
CWCB8X12TS	243	COLUMN WRAP CAP BASE TUSCAN
CWEVFLT10X108SFT	245	COLUMN WRAP EVERCEDAR SQUARE FLAT
CWEVFLT10X120SFT	245	COLUMN WRAP EVERCEDAR SQUARE FLAT
CWEVFLT10X96SFT	245	COLUMN WRAP EVERCEDAR SQUARE FLAT
CWEVFLT11X16X48TFT	246	COLUMN WRAP EVERCEDAR TAPERED FLAT
CWEVFLT11X16X72TFT	246	COLUMN WRAP EVERCEDAR TAPERED FLAT
CWEVFLT12X120SFT	245	COLUMN WRAP EVERCEDAR SQUARE FLAT
CWEVFLT12X96SFT	245	COLUMN WRAP EVERCEDAR SQUARE FLAT
CWEVFLT6X108SFT	245	COLUMN WRAP EVERCEDAR SQUARE FLAT
CWEVFLT6X120SFT	245	COLUMN WRAP EVERCEDAR SQUARE FLAT
CWEVFLT6X96SFT	245	COLUMN WRAP EVERCEDAR SQUARE FLAT
CWEVFLT8X108SFT	245	COLUMN WRAP EVERCEDAR SQUARE FLAT
CWEVFLT8X120SFT	245	COLUMN WRAP EVERCEDAR SQUARE FLAT
CWEVFLT8X96SFT	245	COLUMN WRAP EVERCEDAR SQUARE FLAT
CWINSTALLKIT	230	INSTALLATION KIT
CWPM10X108SFL	235	PREMIUMSELECT SQUARE FLUTED
CWPM10X108SFT	235	PREMIUMSELECT SQUARE FLAT

Part Number	Page	Description
CWPM10X108SRC	235	PREMIUMSELECT SQUARE RECESSED
CWPM10X108SRS	235	PREMIUMSELECT SQUARE RAISED
CWPM10X120SFL	235	PREMIUMSELECT SQUARE FLUTED
CWPM10X120SFT	235	PREMIUMSELECT SQUARE FLAT
CWPM10X120SRC	235	PREMIUMSELECT SQUARE RECESSED
CWPM10X120SRS	235	PREMIUMSELECT SQUARE RAISED
CWPM10X144SFL	235	PREMIUMSELECT SQUARE FLUTED
CWPM10X144SFT	235	PREMIUMSELECT SQUARE FLAT
CWPM10X144SRC	235	PREMIUMSELECT SQUARE RECESSED
CWPM10X144SRS	235	PREMIUMSELECT SQUARE RAISED
CWPM10X72SFL	235	PREMIUMSELECT SQUARE FLUTED
CWPM10X72SFT	235	PREMIUMSELECT SQUARE FLAT
CWPM10X72SRC	235	PREMIUMSELECT SQUARE RECESSED
CWPM10X72SRS	235	PREMIUMSELECT SQUARE RAISED
CWPM10X96SFL	235	PREMIUMSELECT SQUARE FLUTED
CWPM10X96SFT	235	PREMIUMSELECT SQUARE FLAT
CWPM10X96SRC	235	PREMIUMSELECT SQUARE RECESSED
CWPM10X96SRS	235	PREMIUMSELECT SQUARE RAISED
CWPM11X16X48TFT	240	PREMIUMSELECT TAPERED FLAT
CWPM11X16X48TRC	240	PREMIUMSELECT TAPERED RECESSED
CWPM11X16X48TRS	240	PREMIUMSELECT TAPERED RAISED
CWPM11X16X54TFT	240	PREMIUMSELECT TAPERED FLAT
CWPM11X16X54TRC	240	PREMIUMSELECT TAPERED RECESSED
CWPM11X16X54TRS	240	PREMIUMSELECT TAPERED RAISED
CWPM11X16X60TFT	240	PREMIUMSELECT TAPERED FLAT
CWPM11X16X60TRC	240	PREMIUMSELECT TAPERED RECESSED
CWPM11X16X60TRS	240	PREMIUMSELECT TAPERED RAISED

Part Number	Page	Description
CWPM11X16X66TFT	240	PREMIUMSELECT TAPERED FLAT
CWPM11X16X66TRC	240	PREMIUMSELECT TAPERED RECESSED
CWPM11X16X66TRS	240	PREMIUMSELECT TAPERED RAISED
CWPM11X16X72TFT	240	PREMIUMSELECT TAPERED FLAT
CWPM11X16X72TRC	240	PREMIUMSELECT TAPERED RECESSED
CWPM11X16X72TRS	240	PREMIUMSELECT TAPERED RAISED
CWPM11X16X96TFT	240	PREMIUMSELECT TAPERED FLAT
CWPM11X16X96TRC	240	PREMIUMSELECT TAPERED RECESSED
CWPM11X16X96TRS	240	PREMIUMSELECT TAPERED RAISED
CWPM12X108SFL	235	PREMIUMSELECT SQUARE FLUTED
CWPM12X108SFT	235	PREMIUMSELECT SQUARE FLAT
CWPM12X108SRC	235	PREMIUMSELECT SQUARE RECESSED
CWPM12X108SRS	235	PREMIUMSELECT SQUARE RAISED
CWPM12X120SFL	235	PREMIUMSELECT SQUARE FLUTED
CWPM12X120SFT	235	PREMIUMSELECT SQUARE FLAT
CWPM12X120SRC	235	PREMIUMSELECT SQUARE RECESSED
CWPM12X120SRS	235	PREMIUMSELECT SQUARE RAISED
CWPM12X144SFL	235	PREMIUMSELECT SQUARE FLUTED
CWPM12X144SFT	235	PREMIUMSELECT SQUARE FLAT
CWPM12X144SRC	235	PREMIUMSELECT SQUARE RECESSED
CWPM12X144SRS	235	PREMIUMSELECT SQUARE RAISED
CWPM12X72SFL	235	PREMIUMSELECT SQUARE FLUTED
CWPM12X72SFT	235	PREMIUMSELECT SQUARE FLAT
CWPM12X72SRC	235	PREMIUMSELECT SQUARE RECESSED
CWPM12X72SRS	235	PREMIUMSELECT SQUARE RAISED
CWPM12X96SFL	235	PREMIUMSELECT SQUARE FLUTED
CWPM12X96SFT	235	PREMIUMSELECT SQUARE FLAT

Part Number	Page	Description
CWPM12X96SRC	235	PREMIUMSELECT SQUARE RECESSED
CWPM12X96SRS	235	PREMIUMSELECT SQUARE RAISED
CWPM13X20X48TFT	240	PREMIUMSELECT TAPERED FLAT
CWPM13X20X48TRC	240	PREMIUMSELECT TAPERED RECESSED
CWPM13X20X48TRS	240	PREMIUMSELECT TAPERED RAISED
CWPM13X20X54TFT	240	PREMIUMSELECT TAPERED FLAT
CWPM13X20X54TRC	240	PREMIUMSELECT TAPERED RECESSED
CWPM13X20X54TRS	240	PREMIUMSELECT TAPERED RAISED
CWPM13X20X60TFT	240	PREMIUMSELECT TAPERED FLAT
CWPM13X20X60TRC	240	PREMIUMSELECT TAPERED RECESSED
CWPM13X20X60TRS	240	PREMIUMSELECT TAPERED RAISED
CWPM13X20X66TFT	240	PREMIUMSELECT TAPERED FLAT
CWPM13X20X66TRC	240	PREMIUMSELECT TAPERED RECESSED
CWPM13X20X66TRS	240	PREMIUMSELECT TAPERED RAISED
CWPM13X20X72TFT	240	PREMIUMSELECT TAPERED FLAT
CWPM13X20X72TRC	240	PREMIUMSELECT TAPERED RECESSED
CWPM13X20X72TRS	240	PREMIUMSELECT TAPERED RAISED
CWPM13X20X96TFT	240	PREMIUMSELECT TAPERED FLAT
CWPM13X20X96TRC	240	PREMIUMSELECT TAPERED RECESSED
CWPM13X20X96TRS	240	PREMIUMSELECT TAPERED RAISED
CWPM16X24X48TFT	240	PREMIUMSELECT TAPERED FLAT
CWPM16X24X48TRC	240	PREMIUMSELECT TAPERED RECESSED
CWPM16X24X48TRS	240	PREMIUMSELECT TAPERED RAISED
CWPM16X24X54TFT	240	PREMIUMSELECT TAPERED FLAT
CWPM16X24X54TRC	240	PREMIUMSELECT TAPERED RECESSED
CWPM16X24X54TRS	240	PREMIUMSELECT TAPERED RAISED
CWPM16X24X60TFT	240	PREMIUMSELECT TAPERED FLAT

Part Number	Page	Description
CWPM16X24X60TRC	240	PREMIUMSELECT TAPERED RECESSED
CWPM16X24X60TRS	240	PREMIUMSELECT TAPERED RAISED
CWPM16X24X66TFT	240	PREMIUMSELECT TAPERED FLAT
CWPM16X24X66TRC	240	PREMIUMSELECT TAPERED RECESSED
CWPM16X24X66TRS	240	PREMIUMSELECT TAPERED RAISED
CWPM16X24X72TFT	240	PREMIUMSELECT TAPERED FLAT
CWPM16X24X72TRC	240	PREMIUMSELECT TAPERED RECESSED
CWPM16X24X72TRS	240	PREMIUMSELECT TAPERED RAISED
CWPM16X24X96TFT	240	PREMIUMSELECT TAPERED FLAT
CWPM16X24X96TRC	240	PREMIUMSELECT TAPERED RECESSED
CWPM16X24X96TRS	240	PREMIUMSELECT TAPERED RAISED
CWPM6X108SFT	235	PREMIUMSELECT SQUARE FLAT
CWPM6X120SFT	235	PREMIUMSELECT SQUARE FLAT
CWPM6X144SFT	235	PREMIUMSELECT SQUARE FLAT
CWPM6X72SFT	235	PREMIUMSELECT SQUARE FLAT
CWPM6X96SFT	235	PREMIUMSELECT SQUARE FLAT
CWPM8X108SFL	235	PREMIUMSELECT SQUARE FLUTED
CWPM8X108SFT	235	PREMIUMSELECT SQUARE FLAT
CWPM8X108SRC	235	PREMIUMSELECT SQUARE RECESSED
CWPM8X108SRS	235	PREMIUMSELECT SQUARE RAISED
CWPM8X120SFL	235	PREMIUMSELECT SQUARE FLUTED
CWPM8X120SFT	235	PREMIUMSELECT SQUARE FLAT
CWPM8X120SRC	235	PREMIUMSELECT SQUARE RECESSED
CWPM8X120SRS	235	PREMIUMSELECT SQUARE RAISED
CWPM8X12X48TFT	240	PREMIUMSELECT TAPERED FLAT
CWPM8X12X48TRC	240	PREMIUMSELECT TAPERED RECESSED
CWPM8X12X48TRS	240	PREMIUMSELECT TAPERED RAISED

Part Number	Page	Description
CWPM8X12X54TFT	240	PREMIUMSELECT TAPERED FLAT
CWPM8X12X54TRC	240	PREMIUMSELECT TAPERED RECESSED
CWPM8X12X54TRS	240	PREMIUMSELECT TAPERED RAISED
CWPM8X12X60TFT	240	PREMIUMSELECT TAPERED FLAT
CWPM8X12X60TRC	240	PREMIUMSELECT TAPERED RECESSED
CWPM8X12X60TRS	240	PREMIUMSELECT TAPERED RAISED
CWPM8X12X66TFT	240	PREMIUMSELECT TAPERED FLAT
CWPM8X12X66TRC	240	PREMIUMSELECT TAPERED RECESSED
CWPM8X12X66TRS	240	PREMIUMSELECT TAPERED RAISED
CWPM8X12X72TFT	240	PREMIUMSELECT TAPERED FLAT
CWPM8X12X72TRC	240	PREMIUMSELECT TAPERED RECESSED
CWPM8X12X72TRS	240	PREMIUMSELECT TAPERED RAISED
CWPM8X12X96TFT	240	PREMIUMSELECT TAPERED FLAT
CWPM8X12X96TRC	240	PREMIUMSELECT TAPERED RECESSED
CWPM8X12X96TRS	240	PREMIUMSELECT TAPERED RAISED
CWPM8X144SFL	235	PREMIUMSELECT SQUARE FLUTED
CWPM8X144SFT	235	PREMIUMSELECT SQUARE FLAT
CWPM8X144SRC	235	PREMIUMSELECT SQUARE RECESSED
CWPM8X144SRS	235	PREMIUMSELECT SQUARE RAISED
CWPM8X72SFL	235	PREMIUMSELECT SQUARE FLUTED
CWPM8X72SFT	235	PREMIUMSELECT SQUARE FLAT
CWPM8X72SRC	235	PREMIUMSELECT SQUARE RECESSED
CWPM8X72SRS	235	PREMIUMSELECT SQUARE RAISED
CWPM8X96SFL	235	PREMIUMSELECT SQUARE FLUTED
CWPM8X96SFT	235	PREMIUMSELECT SQUARE FLAT
CWPM8X96SRC	235	PREMIUMSELECT SQUARE RECESSED
CWPM8X96SRS	235	PREMIUMSELECT SQUARE RAISED

Part Number	Page	Description
CWPMFL10X10X108SFT	236	PREMIUMSELECT FLAT-PACK SQUARE FLAT COLUMN WRAP
CWPMFL10X10X120SFT	236	PREMIUMSELECT FLAT-PACK SQUARE FLAT COLUMN WRAP
CWPMFL10X10X96SFT	236	PREMIUMSELECT FLAT-PACK SQUARE FLAT COLUMN WRAP
CWPMFL11X16X60TFT	242	PREMIUMSELECT FLAT-PACK TAPERED FLAT COLUMN WRAP
CWPMFL11X16X66TFT	242	PREMIUMSELECT FLAT-PACK TAPERED FLAT COLUMN WRAP
CWPMFL11X16X72TFT	242	PREMIUMSELECT FLAT-PACK TAPERED FLAT COLUMN WRAP
CWPMFL6X6X108SFT	236	PREMIUMSELECT FLAT-PACK SQUARE FLAT COLUMN WRAP
CWPMFL6X6X120SFT	236	PREMIUMSELECT FLAT-PACK SQUARE FLAT COLUMN WRAP
CWPMFL6X6X96SFT	236	PREMIUMSELECT FLAT-PACK SQUARE FLAT COLUMN WRAP
CWPMFL8X12X60TFT	242	PREMIUMSELECT FLAT-PACK TAPERED FLAT COLUMN WRAP
CWPMFL8X12X66TFT	242	PREMIUMSELECT FLAT-PACK TAPERED FLAT COLUMN WRAP
CWPMFL8X12X72TFT	242	PREMIUMSELECT FLAT-PACK TAPERED FLAT COLUMN WRAP
CWPMFL8X8X108SFT	236	PREMIUMSELECT FLAT-PACK SQUARE FLAT COLUMN WRAP
CWPMFL8X8X120SFT	236	PREMIUMSELECT FLAT-PACK SQUARE FLAT COLUMN WRAP
CWPMFL8X8X96SFT	236	PREMIUMSELECT FLAT-PACK SQUARE FLAT COLUMN WRAP
CWPR10X108SFT	232	PROSELECT SQUARE FLAT
CWPR10X120SFT	232	PROSELECT SQUARE FLAT
CWPR10X144SFT	232	PROSELECT SQUARE FLAT
CWPR10X72SFT	232	PROSELECT SQUARE FLAT
CWPR10X96SFT	232	PROSELECT SQUARE FLAT
CWPR12X108SFT	232	PROSELECT SQUARE FLAT
CWPR12X120SFT	232	PROSELECT SQUARE FLAT
CWPR12X144SFT	232	PROSELECT SQUARE FLAT
CWPR12X72SFT	232	PROSELECT SQUARE FLAT
CWPR12X96SFT	232	PROSELECT SQUARE FLAT
CWPR6X108SFT	232	PROSELECT SQUARE FLAT
CWPR6X120SFT	232	PROSELECT SQUARE FLAT

Part Number	Page	Description
CWPR6X144SFT	232	PROSELECT SQUARE FLAT
CWPR6X72SFT	232	PROSELECT SQUARE FLAT
CWPR6X96SFT	232	PROSELECT SQUARE FLAT
CWPR8X108SFT	232	PROSELECT SQUARE FLAT
CWPR8X120SFT	232	PROSELECT SQUARE FLAT
CWPR8X144SFT	232	PROSELECT SQUARE FLAT
CWPR8X72SFT	232	PROSELECT SQUARE FLAT
CWPR8X96SFT	232	PROSELECT SQUARE FLAT
CWPRFLT6X6X108SFT	233	PROSELECT FLAT-PACK SQUARE FLAT COLUMN WRAP
CWPRFLT6X6X96SFT	233	PROSELECT FLAT-PACK SQUARE FLAT COLUMN WRAP
D		
DLV24X24	227	DIAMOND LOUVER DECO SMOOTH
DMP44	88	DORMER TRIM SYSTEM PEDIMENT SMOOTH
DMR457-10	88	DORMER TRIM SYSTEM RETURN SMOOTH
DMST7X69	88	DORMER TRIM SYSTEM SIDE TRIM SMOOTH
DTLB3.5X3.5X7	182	DENTIL BLOCK SMOOTH
DTLB3.5X5.5X5.5	188	DENTIL BLOCK SMOOTH
DTLB3X3X3	182	DENTIL BLOCK SMOOTH
DTLB3X3X4	188	DENTIL BLOCK SMOOTH
DTLB4X4X4	188	DENTIL BLOCK SMOOTH
DTLB4X4X7	185	DENTIL BLOCK SMOOTH
DTLB4X4X9	185	DENTIL BLOCK SMOOTH
DTLB4X5X7	188	DENTIL BLOCK SMOOTH
DTLB4X5X8	183	DENTIL BLOCK SMOOTH
DTLB4X6X6	184	DENTIL BLOCK SMOOTH
DTLB4X6X7	186	DENTIL BLOCK SMOOTH
DTLB4X6X9	182	DENTIL BLOCK SMOOTH

Part Number	Page	Description
DTLB5X4X7	186	DENTIL BLOCK SMOOTH
DTLB5X6X10	183	DENTIL BLOCK SMOOTH
DTLB5X6X11	186	DENTIL BLOCK SMOOTH
DTLB5X6X18	182	DENTIL BLOCK SMOOTH
DTLB5X6X6	182	DENTIL BLOCK SMOOTH
DTLB5X6X8	182	DENTIL BLOCK SMOOTH
DTLB5X8	185	DENTIL BLOCK SMOOTH
DTLB5X8X10	187	DENTIL BLOCK SMOOTH
DTLB6X4X6	187	DENTIL BLOCK SMOOTH
DTLB6X4X6L12	189	DENTIL BLOCK SMOOTH
DTLB6X4X6R12	189	DENTIL BLOCK SMOOTH
DTLB6X5X7	187	DENTIL BLOCK SMOOTH
DTLB6X6X5	187	DENTIL BLOCK SMOOTH
DTLB6X6X8	186	DENTIL BLOCK SMOOTH
DTLB6X6X9	184	DENTIL BLOCK SMOOTH
DTLB6X6X9.25	187	DENTIL BLOCK SMOOTH
DTLB6X7X9	184	DENTIL BLOCK SMOOTH
DTLB6X9X7	183	DENTIL BLOCK SMOOTH
DTLB8X6X6	188	DENTIL BLOCK SMOOTH
DTLB9X11X16	185	DENTIL BLOCK SMOOTH
DTLB9X8X8	184	DENTIL BLOCK SMOOTH

E

EBLV12X24	215	EYEBROW LOUVER DECO SMOOTH
EBLV18X30	215	EYEBROW LOUVER DECO SMOOTH
EBLV22X32	215	EYEBROW LOUVER DECO SMOOTH

F

F100	182	DENTIL BLOCK SMOOTH
------	-----	---------------------

Part Number	Page	Description
FCLV12X24	214	LOUVER FUNC CATHEDRAL SMOOTH
FCLV14X22	214	LOUVER FUNC CATHEDRAL SMOOTH
FCLV16X36	214	LOUVER FUNC CATHEDRAL SMOOTH
FCLV18X24	214	LOUVER FUNC CATHEDRAL SMOOTH
FCLV18X30	214	LOUVER FUNC CATHEDRAL SMOOTH
FCLV22X31	214	LOUVER FUNC CATHEDRAL SMOOTH
FCLV24X48	214	LOUVER FUNC CATHEDRAL SMOOTH
FCLV28X43	214	LOUVER FUNC CATHEDRAL SMOOTH
FCLV36X48	214	LOUVER FUNC CATHEDRAL SMOOTH
FDLV24X24	227	LOUVER FUNC DIAMOND SMOOTH
FEBLV12X24	215	LOUVER FUNC EYEBROW SMOOTH
FEBLV18X30	215	LOUVER FUNC EYEBROW SMOOTH
FEBLV22X32	215	LOUVER FUNC EYEBROW SMOOTH
FHRLV24X12	220	LOUVER FUNC HALF ROUND SMOOTH
FHRLV28X14	220	LOUVER FUNC HALF ROUND SMOOTH
FHRLV32X16	220	LOUVER FUNC HALF ROUND SMOOTH
FHRLV36X18	220	LOUVER FUNC HALF ROUND SMOOTH
FHRLV36X18MTK	221	LOUVER FUNC HALF ROUND W/DECO T,K SMOOTH
FHRLV40X20	220	LOUVER FUNC HALF ROUND SMOOTH
FHRLV42X21	220	LOUVER FUNC HALF ROUND SMOOTH
FHRLV48X24	220	LOUVER FUNC HALF ROUND SMOOTH
FHRLV60X30	220	LOUVER FUNC HALF ROUND SMOOTH
FLT100-12	94	FLAT TRIM SMOOTH
FLT101-12	94	FLAT TRIM SMOOTH
FLT102-10	94	FLAT TRIM SMOOTH
FLT103-12	94	FLAT TRIM SMOOTH
FLT109-12	94	FLAT TRIM SMOOTH

Part Number	Page	Description
FLT110-12S	97	FLAT TRIM, TIMBER TEXTURE
FLT110-16	94	FLAT TRIM SMOOTH
FLT111-12S	97	FLAT TRIM, TIMBER TEXTURE
FLT113-8	94	FLAT TRIM SMOOTH
FLT118-8	94	FLAT TRIM SMOOTH
FLT119-17	95	FLAT TRIM SMOOTH
FLT122-16	94	FLAT TRIM SMOOTH
FLT131-16	94	FLAT TRIM SMOOTH
FLT150-12S	97	FLAT TRIM, TIMBER TEXTURE
FLT151-12S	97	FLAT TRIM, TIMBER TEXTURE
FLT152-12	94	FLAT TRIM SMOOTH
FLT152-16	94	FLAT TRIM SMOOTH
FLT152-8	94	FLAT TRIM SMOOTH
FLT153-12	94	FLAT TRIM SMOOTH
FLT159-12	94	FLAT TRIM SMOOTH
FLT159-16	94	FLAT TRIM SMOOTH
FLT159-8	94	FLAT TRIM SMOOTH
FLT162-8	94	FLAT TRIM SMOOTH
FLT163-16	95	FLAT TRIM SMOOTH
FLT170-12	94	FLAT TRIM SMOOTH
FLT170-16	94	FLAT TRIM SMOOTH
FLT172-16	94	FLAT TRIM SMOOTH
FLT173-12S	97	FLAT TRIM, TIMBER TEXTURE
FLT175-12	94	FLAT TRIM SMOOTH
FLT179-12	94	FLAT TRIM SMOOTH
FLT180-12	95	FLAT TRIM SMOOTH
FLT182-12	95	FLAT TRIM SMOOTH

Part Number	Page	Description
FLT183-12	95	FLAT TRIM SMOOTH
FLT186-116	94	FLAT TRIM SMOOTH
FLT187-12S	97	FLAT TRIM, TIMBER TEXTURE
FLT190-12	95	FLAT TRIM SMOOTH
FLT194-10	95	FLAT TRIM SMOOTH
FLT197-12S	97	FLAT TRIM, TIMBER TEXTURE
FLT1X4-12RS	53, 97	BATTEN, TIMBER TEXTURE
FLT30X228X1S	97	FLAT TRIM, TIMBER TEXTURE
FLT40X96	95	WINDOW PANEL FLAT SMOOTH
FLT9X4X216S	97	FLAT TRIM, TIMBER TEXTURE
FLTBA36X3X3	202	TRELLIS LATTICE SMOOTH
FLTBA36X3X3S	204	TRELLIS LATTICE TIMBER TEXTURE
FLV12X18	216	LOUVER FUNC RECT VERT SMOOTH
FLV12X24	216	LOUVER FUNC RECT VERT SMOOTH
FLV12X30	216	LOUVER FUNC RECT VERT SMOOTH
FLV12X36	216	LOUVER FUNC RECT VERT SMOOTH
FLV12X40	217	LOUVER FUNC RECT VERT SMOOTH
FLV14X27	217	LOUVER FUNC RECT VERT SMOOTH
FLV14X30	217	LOUVER FUNC RECT VERT SMOOTH
FLV14X32	217	LOUVER FUNC RECT VERT SMOOTH
FLV16X24	217	LOUVER FUNC RECT VERT SMOOTH
FLV16X36	217	LOUVER FUNC RECT VERT SMOOTH
FLV18X24	217	LOUVER FUNC RECT VERT SMOOTH
FLV18X24-4F6WCH	218	LOUVER FUNC RECT VERT W/TRIM & CRSHD SMOOTH
FLV18X30	217	LOUVER FUNC RECT VERT SMOOTH
FLV18X36	217	LOUVER FUNC RECT VERT SMOOTH
FLV18X42	217	LOUVER FUNC RECT VERT SMOOTH

Part Number	Page	Description
FLV20X28	217	LOUVER FUNC RECT VERT SMOOTH
FLV24X24	217	LOUVER FUNC RECT VERT SMOOTH
FLV24X30	217	LOUVER FUNC RECT VERT SMOOTH
FLV24X36	217	LOUVER FUNC RECT VERT SMOOTH
FLV24X48	217	LOUVER FUNC RECT VERT SMOOTH
FLV27X17	219	LOUVER FUNC RECT VERT SMOOTH
FLV30X42	217	LOUVER FUNC RECT VERT SMOOTH
FLV32X16	219	LOUVER FUNC RECT VERT SMOOTH
FLV8X15	216	LOUVER FUNC RECT VERT SMOOTH
FLV8X24	216	LOUVER FUNC RECT VERT SMOOTH
FLV8X30	216	LOUVER FUNC RECT VERT SMOOTH
FLVNS18X24	218	LOUVER FUNC RECT VERT NO SILL SMOOTH
FMS8X8X2	206	FIXTURE MOUNT SMOOTH
FOLV18	227	LOUVER FUNC OCTAGON SMOOTH
FOLV22	227	LOUVER FUNC OCTAGON SMOOTH
FOLV24	227	LOUVER FUNC OCTAGON SMOOTH
FOLV28	227	LOUVER FUNC OCTAGON SMOOTH
FOVL28X35K215V	225	LOUVER FUNC OVAL VERT W/ DC TRIM & KEY SMOOTH
FOVL35X28K215	225	LOUVER FUNC OVAL HORZ W/ DC TRIM & KEY SMOOTH
FOVLV18X24V	225	LOUVER FUNC OVAL VERT SMOOTH
FOVLV25X37V	225	LOUVER FUNC OVAL VERT SMOOTH
FPLV18X24-8	215	LOUVER FUNC PEAKED SMOOTH
FPLV18X36-10	215	LOUVER FUNC PEAKED SMOOTH
FPLV24X36-12	215	LOUVER FUNC PEAKED SMOOTH
FRLV12	222	LOUVER FUNC ROUND SMOOTH
FRLV16	222	LOUVER FUNC ROUND SMOOTH
FRLV16MTK	223	LOUVER FUNC ROUND W/ DC TRIM & KEY SMOOTH

Part Number	Page	Description
FRLV18	222	LOUVER FUNC ROUND SMOOTH
FRLV18MTK	223	LOUVER FUNC ROUND W/ DC TRIM & KEY SMOOTH
FRLV24	222	LOUVER FUNC ROUND SMOOTH
FRLV24-4FTK	223	LOUVER FUNC ROUND W/ DC TRIM & KEY SMOOTH
FRLV24-6TK	223	LOUVER FUNC ROUND W/ FL TRIM & FLAT KEY SMOOTH
FRLV24MTK	223	LOUVER FUNC ROUND W/ DC TRIM & KEY SMOOTH
FRLV24TK	224	LOUVER FUNC ROUND W/ FL TRIM & FLAT KEY SMOOTH
FRLV30	222	LOUVER FUNC ROUND SMOOTH
FRLV30-6TK	223	LOUVER FUNC ROUND W/ FL TRIM & FLAT KEY SMOOTH
FRLV30MTK	223	LOUVER FUNC ROUND W/ DC TRIM & KEY SMOOTH
FRLV32-2F	222	LOUVER FUNC ROUND W/ FL TRIM SMOOTH
FRLV32MTK	223	LOUVER FUNC ROUND W/ DC TRIM & KEY SMOOTH
FRLV36	222	LOUVER FUNC ROUND SMOOTH
FRLV36TK	224	LOUVER FUNC ROUND W/ FL TRIM & FK SMOOTH
FRLV42	222	LOUVER FUNC ROUND SMOOTH
FRLV48	222	LOUVER FUNC ROUND SMOOTH
FSR103X17	207	FISHSCALE PANEL SMOOTH
FTRLV36X18	226	LOUVER FUNC TRIANGLE SMOOTH
FTRLV42X21	226	LOUVER FUNC TRIANGLE SMOOTH
FTRLV48X12	226	LOUVER FUNC TRIANGLE SMOOTH
FTRLV48X18	226	LOUVER FUNC TRIANGLE SMOOTH
FTRLV48X22	226	LOUVER FUNC TRIANGLE SMOOTH
FTRLV48X24	226	LOUVER FUNC TRIANGLE SMOOTH
FTRLV60X18	226	LOUVER FUNC TRIANGLE SMOOTH
FTRLV60X23	226	LOUVER FUNC TRIANGLE SMOOTH
FTRLV60X25	226	LOUVER FUNC TRIANGLE SMOOTH
FTRLV60X30	226	LOUVER FUNC TRIANGLE SMOOTH

Part Number	Page	Description
FTRLV64X27	226	LOUVER FUNC TRIANGLE SMOOTH
FTRLV64X32	226	LOUVER FUNC TRIANGLE SMOOTH
FTRLV66X22	226	LOUVER FUNC TRIANGLE SMOOTH
FTRLV72X36	226	LOUVER FUNC TRIANGLE SMOOTH
FTRLV76X19	226	LOUVER FUNC TRIANGLE SMOOTH
FTRLV84X18	226	LOUVER FUNC TRIANGLE SMOOTH
FTRLV84X21	226	LOUVER FUNC TRIANGLE SMOOTH
FTRLV88X22	226	LOUVER FUNC TRIANGLE SMOOTH
FTRLVLR115X35	227	LOUVER FUNC 2PC TRIANGLE SMOOTH
FTRLVLR120X30	227	LOUVER FUNC 2PC TRIANGLE SMOOTH
FTRLVLR60X25	227	LOUVER FUNC 2PC TRIANGLE SMOOTH
FTRLVLR60X30	227	LOUVER FUNC 2PC TRIANGLE SMOOTH

G

GBPAC108X40.5X3.5RS	161	GABLE BRACKET PEDIMENT ASHER CHAMFERED ROUGH SAWN
GBPAC60X22.5X3.5RS	161	GABLE BRACKET PEDIMENT ASHER CHAMFERED ROUGH SAWN
GBPAC84X31.5X3.5RS	161	GABLE BRACKET PEDIMENT ASHER CHAMFERED ROUGH SAWN
GBPAC84X38.5X3.5RS	161	GABLE BRACKET PEDIMENT ASHER CHAMFERED ROUGH SAWN
GBPB108X27X3.5RS	157	GABLE BRACKET PEDIMENT BURNHAM ROUGH SAWN
GBPB108X40.5X3.5RS	157	GABLE BRACKET PEDIMENT BURNHAM ROUGH SAWN
GBPB108X49.5X3.5RS	157	GABLE BRACKET PEDIMENT BURNHAM ROUGH SAWN
GBPB108X54X3.5RS	157	GABLE BRACKET PEDIMENT BURNHAM ROUGH SAWN
GBPB60X17.5X3.5RS	156	GABLE BRACKET PEDIMENT BURNHAM ROUGH SAWN
GBPB60X20X3.5RS	156	GABLE BRACKET PEDIMENT BURNHAM ROUGH SAWN
GBPB60X25X3.5RS	156	GABLE BRACKET PEDIMENT BURNHAM ROUGH SAWN
GBPB60X27.5X3.5RS	156	GABLE BRACKET PEDIMENT BURNHAM ROUGH SAWN
GBPB60X30X3.5RS	156	GABLE BRACKET PEDIMENT BURNHAM ROUGH SAWN
GBPB72X15X3.5RS	156	GABLE BRACKET PEDIMENT BURNHAM ROUGH SAWN

Part Number	Page	Description
GBPB72X21X3.5RS	156	GABLE BRACKET PEDIMENT BURNHAM ROUGH SAWN
GBPB72X24X3.5RS	156	GABLE BRACKET PEDIMENT BURNHAM ROUGH SAWN
GBPB72X30X3.5RS	156	GABLE BRACKET PEDIMENT BURNHAM ROUGH SAWN
GBPB72X36X3.5RS	156	GABLE BRACKET PEDIMENT BURNHAM ROUGH SAWN
GBPB84X17.5X3.5RS	156	GABLE BRACKET PEDIMENT BURNHAM ROUGH SAWN
GBPB84X21X3.5RS	156	GABLE BRACKET PEDIMENT BURNHAM ROUGH SAWN
GBPB84X28X3.5RS	156	GABLE BRACKET PEDIMENT BURNHAM ROUGH SAWN
GBPB96X36X3.5RS	156	GABLE BRACKET PEDIMENT BURNHAM ROUGH SAWN
GBPB96X40X3.5RS	157	GABLE BRACKET PEDIMENT BURNHAM ROUGH SAWN
GBPB96X44X3.5RS	157	GABLE BRACKET PEDIMENT BURNHAM ROUGH SAWN
GBPB96X48X3.5RS	157	GABLE BRACKET PEDIMENT BURNHAM ROUGH SAWN
GBPBC108X31.5X3.5RS	157	GABLE BRACKET PEDIMENT BURNHAM CHAMFERED ROUGH SAWN
GBPBC108X36X3.5RS	157	GABLE BRACKET PEDIMENT BURNHAM CHAMFERED ROUGH SAWN
GBPBC108X40.5X3.5RS	157	GABLE BRACKET PEDIMENT BURNHAM CHAMFERED ROUGH SAWN
GBPBC60X15X3.5RS	156	GABLE BRACKET PEDIMENT BURNHAM CHAMFERED ROUGH SAWN
GBPBC60X17.5X3.5RS	156	GABLE BRACKET PEDIMENT BURNHAM CHAMFERED ROUGH SAWN
GBPBC60X22.5X3.5RS	156	GABLE BRACKET PEDIMENT BURNHAM CHAMFERED ROUGH SAWN
GBPBC60X27.5X3.5RS	156	GABLE BRACKET PEDIMENT BURNHAM CHAMFERED ROUGH SAWN
GBPBC60X30X3.5RS	156	GABLE BRACKET PEDIMENT BURNHAM CHAMFERED ROUGH SAWN
GBPBC72X15X3.5RS	156	GABLE BRACKET PEDIMENT BURNHAM CHAMFERED ROUGH SAWN
GBPBC72X18X3.5RS	156	GABLE BRACKET PEDIMENT BURNHAM CHAMFERED ROUGH SAWN
GBPBC72X21X3.5RS	156	GABLE BRACKET PEDIMENT BURNHAM CHAMFERED ROUGH SAWN
GBPBC72X36X3.5RS	156	GABLE BRACKET PEDIMENT BURNHAM CHAMFERED ROUGH SAWN
GBPBC84X17.5X3.5RS	156	GABLE BRACKET PEDIMENT BURNHAM CHAMFERED ROUGH SAWN
GBPBC84X35X3.5RS	156	GABLE BRACKET PEDIMENT BURNHAM CHAMFERED ROUGH SAWN
GBPBC96X24X3.5RS	156	GABLE BRACKET PEDIMENT BURNHAM CHAMFERED ROUGH SAWN
GBPBC96X28X3.5RS	156	GABLE BRACKET PEDIMENT BURNHAM CHAMFERED ROUGH SAWN

Part Number	Page	Description
GBPBC96X32X3.5RS	156	GABLE BRACKET PEDIMENT BURNHAM CHAMFERED ROUGH SAWN
GBPBC96X36X3.5RS	156	GABLE BRACKET PEDIMENT BURNHAM CHAMFERED ROUGH SAWN
GBPBC96X44X3.5RS	157	GABLE BRACKET PEDIMENT BURNHAM CHAMFERED ROUGH SAWN
GBPM108X22.5X3.5RS	159	GABLE BRACKET PEDIMENT MEIER ROUGH SAWN
GBPM108X31.5X3.5RS	159	GABLE BRACKET PEDIMENT MEIER ROUGH SAWN
GBPM108X40.5X3.5RS	159	GABLE BRACKET PEDIMENT MEIER ROUGH SAWN
GBPM108X45X3.5RS	159	GABLE BRACKET PEDIMENT MEIER ROUGH SAWN
GBPM108X49.5X3.5RS	159	GABLE BRACKET PEDIMENT MEIER ROUGH SAWN
GBPM108X54X3.5RS	159	GABLE BRACKET PEDIMENT MEIER ROUGH SAWN
GBPM60X12.5X3.5RS	158	GABLE BRACKET PEDIMENT MEIER ROUGH SAWN
GBPM60X15X3.5RS	158	GABLE BRACKET PEDIMENT MEIER ROUGH SAWN
GBPM60X17.5X3.5RS	158	GABLE BRACKET PEDIMENT MEIER ROUGH SAWN
GBPM60X20X3.5RS	158	GABLE BRACKET PEDIMENT MEIER ROUGH SAWN
GBPM60X27.5X3.5RS	158	GABLE BRACKET PEDIMENT MEIER ROUGH SAWN
GBPM72X15X3.5RS	158	GABLE BRACKET PEDIMENT MEIER ROUGH SAWN
GBPM72X18X3.5RS	158	GABLE BRACKET PEDIMENT MEIER ROUGH SAWN
GBPM72X27X3.5RS	158	GABLE BRACKET PEDIMENT MEIER ROUGH SAWN
GBPM72X33X3.5RS	158	GABLE BRACKET PEDIMENT MEIER ROUGH SAWN
GBPM84X17.5X3.5RS	158	GABLE BRACKET PEDIMENT MEIER ROUGH SAWN
GBPM84X21X3.5RS	158	GABLE BRACKET PEDIMENT MEIER ROUGH SAWN
GBPM84X28X3.5RS	158	GABLE BRACKET PEDIMENT MEIER ROUGH SAWN
GBPM84X31.5X3.5RS	158	GABLE BRACKET PEDIMENT MEIER ROUGH SAWN
GBPM84X35X3.5RS	158	GABLE BRACKET PEDIMENT MEIER ROUGH SAWN
GBPM84X38.5X3.5RS	158	GABLE BRACKET PEDIMENT MEIER ROUGH SAWN
GBPM96X20X3.5RS	158	GABLE BRACKET PEDIMENT MEIER ROUGH SAWN
GBPM96X32X3.5RS	158	GABLE BRACKET PEDIMENT MEIER ROUGH SAWN
GBPM96X36X3.5RS	159	GABLE BRACKET PEDIMENT MEIER ROUGH SAWN

Part Number	Page	Description
GBPM96X40X3.5RS	159	GABLE BRACKET PEDIMENT MEIER ROUGH SAWN
GBPM96X44X3.5RS	159	GABLE BRACKET PEDIMENT MEIER ROUGH SAWN
GBPM96X48X3.5RS	159	GABLE BRACKET PEDIMENT MEIER ROUGH SAWN
GBPMC108X27X3.5RS	159	GABLE BRACKET PEDIMENT MEIER CHAMFERED ROUGH SAWN
GBPMC108X31.5X3.5RS	159	GABLE BRACKET PEDIMENT MEIER CHAMFERED ROUGH SAWN
GBPMC108X54X3.5RS	159	GABLE BRACKET PEDIMENT MEIER CHAMFERED ROUGH SAWN
GBPMC60X12.5X3.5RS	158	GABLE BRACKET PEDIMENT MEIER CHAMFERED ROUGH SAWN
GBPMC60X17.5X3.5RS	158	GABLE BRACKET PEDIMENT MEIER CHAMFERED ROUGH SAWN
GBPMC60X22.5X3.5RS	158	GABLE BRACKET PEDIMENT MEIER CHAMFERED ROUGH SAWN
GBPMC60X27.5X3.5RS	158	GABLE BRACKET PEDIMENT MEIER CHAMFERED ROUGH SAWN
GBPMC72X15X3.5RS	158	GABLE BRACKET PEDIMENT MEIER CHAMFERED ROUGH SAWN
GBPMC72X24X3.5RS	158	GABLE BRACKET PEDIMENT MEIER CHAMFERED ROUGH SAWN
GBPMC72X27X3.5RS	158	GABLE BRACKET PEDIMENT MEIER CHAMFERED ROUGH SAWN
GBPMC72X30X3.5RS	158	GABLE BRACKET PEDIMENT MEIER CHAMFERED ROUGH SAWN
GBPMC72X33X3.5RS	158	GABLE BRACKET PEDIMENT MEIER CHAMFERED ROUGH SAWN
GBPMC72X36X3.5RS	158	GABLE BRACKET PEDIMENT MEIER CHAMFERED ROUGH SAWN
GBPMC84X21X3.5RS	158	GABLE BRACKET PEDIMENT MEIER CHAMFERED ROUGH SAWN
GBPMC84X24.5X3.5RS	158	GABLE BRACKET PEDIMENT MEIER CHAMFERED ROUGH SAWN
GBPMC84X31.5X3.5RS	158	GABLE BRACKET PEDIMENT MEIER CHAMFERED ROUGH SAWN
GBPMC84X38.5X3.5RS	158	GABLE BRACKET PEDIMENT MEIER CHAMFERED ROUGH SAWN
GBPMC84X42X3.5RS	158	GABLE BRACKET PEDIMENT MEIER CHAMFERED ROUGH SAWN
GBPMC96X28X3.5RS	159	GABLE BRACKET PEDIMENT MEIER CHAMFERED ROUGH SAWN
GBPMC96X32X3.5RS	159	GABLE BRACKET PEDIMENT MEIER CHAMFERED ROUGH SAWN
GBPMC96X36X3.5RS	159	GABLE BRACKET PEDIMENT MEIER CHAMFERED ROUGH SAWN
GBPMC96X40X3.5RS	159	GABLE BRACKET PEDIMENT MEIER CHAMFERED ROUGH SAWN
GBPMC96X44X3.5RS	159	GABLE BRACKET PEDIMENT MEIER CHAMFERED ROUGH SAWN
GBPMC96X48X3.5RS	159	GABLE BRACKET PEDIMENT MEIER CHAMFERED ROUGH SAWN

Part Number	Page	Description
GBPSC60X22.5X3.5RS	160	GABLE BRACKET PEDIMENT SULLIVAN CHAMFERED ROUGH SAWN
GBPSC60X25X3.5RS	160	GABLE BRACKET PEDIMENT SULLIVAN CHAMFERED ROUGH SAWN
GBPSC60X27.5X3.5RS	160	GABLE BRACKET PEDIMENT SULLIVAN CHAMFERED ROUGH SAWN
GBPSC60X30X3.5RS	160	GABLE BRACKET PEDIMENT SULLIVAN CHAMFERED ROUGH SAWN
GBPSC84X28X3.5RS	160	GABLE BRACKET PEDIMENT SULLIVAN CHAMFERED ROUGH SAWN
GBPSC84X35X3.5RS	160	GABLE BRACKET PEDIMENT SULLIVAN CHAMFERED ROUGH SAWN
GBPSC84X38.5X3.5RS	160	GABLE BRACKET PEDIMENT SULLIVAN CHAMFERED ROUGH SAWN
GBPSC84X42X3.5RS	160	GABLE BRACKET PEDIMENT SULLIVAN CHAMFERED ROUGH SAWN
GP64X32	164	GABLE PEDIMENT VICTORIAN SMOOTH
GP80X33	164	GABLE PEDIMENT VICTORIAN SMOOTH
GP88X29	164	GABLE PEDIMENT VICTORIAN SMOOTH
GP96X28	164	GABLE PEDIMENT VICTORIAN SMOOTH
GPA104X26	165	GABLE PEDIMENT ARCHED SMOOTH
GPA70X35	165	GABLE PEDIMENT ARCHED SMOOTH
GPA81X34	165	GABLE PEDIMENT ARCHED SMOOTH
GPA86X32	165	GABLE PEDIMENT ARCHED SMOOTH
GPA87X29	165	GABLE PEDIMENT ARCHED SMOOTH
GPA95X28	165	GABLE PEDIMENT ARCHED SMOOTH
GPF66X22	163	GABLE PEDIMENT FLAT SMOOTH
GPF66X24.75	163	GABLE PEDIMENT FLAT SMOOTH
GPF66X27.5	163	GABLE PEDIMENT FLAT SMOOTH
GPF66X33	163	GABLE PEDIMENT FLAT SMOOTH
GPF96X20RS	162	GABLE PEDIMENT FLAT ROUGH SAWN
GPF96X24RS	162	GABLE PEDIMENT FLAT ROUGH SAWN
GPK100	165	GABLE PEDIMENT BASIC SMOOTH
H		
HRLV24X12	220	HALF ROUND LOUVER DECO SMOOTH

Part Number	Page	Description
HRLV28X14	220	HALF ROUND LOUVER DECO SMOOTH
HRLV29-6FKWD	221	LOUVER DECO HALF ROUND W/DECO T,D,K SMOOTH
HRLV32X16	220	HALF ROUND LOUVER DECO SMOOTH
HRLV36X18	220	HALF ROUND LOUVER DECO SMOOTH
HRLV36X18-4F	221	HALF ROUND W/ FL TRIM LOUVER DECO SMOOTH
HRLV36X18-6F	221	HALF ROUND W/ FL TRIM LOUVER DECO SMOOTH
HRLV36X18MTK	221	LOUVER DECO HALF ROUND W/ DC TRIM & KEY SMOOTH
HRLV40X20	220	HALF ROUND LOUVER DECO SMOOTH
HRLV42X21	220	HALF ROUND LOUVER DECO SMOOTH
HRLV48X24	220	HALF ROUND LOUVER DECO SMOOTH
HRLV60X30	220	HALF ROUND LOUVER DECO SMOOTH
HRLV72X36	220	HALF ROUND LOUVER DECO SMOOTH
HRSP36X18	68	PEDIMENT HALF ROUND SPKD SMOOTH
K		
K10SEG	89	KEYSTONE CROSSHEAD PROFILE SMOOTH
K10TM	89	KEYSTONE TRIM PROFILE SMOOTH
K12M	89	KEYSTONE CROSSHEAD PROFILE SMOOTH
K4TF	89	KEYSTONE TRIM PROFILE SMOOTH
K4TM	89	KEYSTONE TRIM PROFILE SMOOTH
K6	89	KEYSTONE SOLID SMOOTH
K6M	89	KEYSTONE CROSSHEAD PROFILE SMOOTH
K6TF	89	KEYSTONE TRIM PROFILE SMOOTH
K6TM	89	KEYSTONE TRIM PROFILE SMOOTH
K8	89	KEYSTONE SOLID SMOOTH
K8TF	89	KEYSTONE TRIM PROFILE SMOOTH
K9M	89	KEYSTONE CROSSHEAD PROFILE SMOOTH
KP4TF	89	KEYSTONE TRIM PROFILE SMOOTH

Part Number	Page	Description
KP4TM	89	KEystone TRIM PROFILE SMOOTH
KP6M	89	KEystone CROSSHEAD PROFILE SMOOTH
KP6TF	89	KEystone TRIM PROFILE SMOOTH
KP6TM	89	KEystone TRIM PROFILE SMOOTH
KP9M	89	KEystone CROSSHEAD PROFILE SMOOTH
KWM180M	89	KEystone BRICK MOULD PROFILE SMOOTH
L		
LDCH58X18	67	CROSSHEAD LARGE DOOR SMOOTH
LDCH62X18	67	CROSSHEAD LARGE DOOR SMOOTH
LDCH87X18	67	CROSSHEAD LARGE DOOR SMOOTH
LDCH90X18	67	CROSSHEAD LARGE DOOR SMOOTH
LDCH94X18	67	CROSSHEAD LARGE DOOR SMOOTH
LV12X18	216	RECTANGLE VERTICAL LOUVER DECO SMOOTH
LV12X24	216	RECTANGLE VERTICAL LOUVER DECO SMOOTH
LV12X30	216	RECTANGLE VERTICAL LOUVER DECO SMOOTH
LV12X36	216	RECTANGLE VERTICAL LOUVER DECO SMOOTH
LV12X40	217	RECTANGLE VERTICAL LOUVER DECO SMOOTH
LV14X27	217	RECTANGLE VERTICAL LOUVER DECO SMOOTH
LV14X30	217	RECTANGLE VERTICAL LOUVER DECO SMOOTH
LV14X32	217	RECTANGLE VERTICAL LOUVER DECO SMOOTH
LV16X24	217	RECTANGLE VERTICAL LOUVER DECO SMOOTH
LV16X36	217	RECTANGLE VERTICAL LOUVER DECO SMOOTH
LV18X24	217	RECTANGLE VERTICAL LOUVER DECO SMOOTH
LV18X24-4F6WCH	218	LOUVER DECO RECT VRTCL W/TRIM & CRSHD SMOOTH
LV18X30	217	RECTANGLE VERTICAL LOUVER DECO SMOOTH
LV18X30-4F	219	RECTANGLE VERTICAL W/TRIM LOUVER DECO SMOOTH
LV18X36	217	RECTANGLE VERTICAL LOUVER DECO SMOOTH

Part Number	Page	Description
LV18X42	217	RECTANGLE VERTICAL LOUVER DECO SMOOTH
LV20X28	217	RECTANGLE VERTICAL LOUVER DECO SMOOTH
LV24X24	217	RECTANGLE VERTICAL LOUVER DECO SMOOTH
LV24X30	217	RECTANGLE VERTICAL LOUVER DECO SMOOTH
LV24X36	217	RECTANGLE VERTICAL LOUVER DECO SMOOTH
LV24X48	217	RECTANGLE VERTICAL LOUVER DECO SMOOTH
LV27X17	219	RECTANGLE VERTICAL LOUVER DECO SMOOTH
LV30X42	217	RECTANGLE VERTICAL LOUVER DECO SMOOTH
LV32X16	219	RECTANGLE VERTICAL LOUVER DECO SMOOTH
LV8X15	216	RECTANGLE VERTICAL LOUVER DECO SMOOTH
LV8X24	216	RECTANGLE VERTICAL LOUVER DECO SMOOTH
LV8X30	216	RECTANGLE VERTICAL LOUVER DECO SMOOTH
LVNS18X24	218	RECTANGLE VERTICAL NO SILL LOUVER DECO SMOOTH
LVSH12X36FNCR	24	SHUTTER LOUVERED W/CENTER RAIL SMOOTH
LVSH12X48FNCR	24	SHUTTER LOUVERED W/CENTER RAIL SMOOTH
LVSH16X54FNB	24	SHUTTER LOUVERED SMOOTH
LVSH16X54FNCR	24	SHUTTER LOUVERED W/CENTER RAIL SMOOTH
LVSH16X60FNCR	24	SHUTTER LOUVERED W/CENTER RAIL SMOOTH
LVSH16X72FNB	24	SHUTTER LOUVERED SMOOTH
LVSH16X72FNCR	24	SHUTTER LOUVERED W/CENTER RAIL SMOOTH
LVSH16X80FNCR	24	SHUTTER LOUVERED W/CENTER RAIL SMOOTH
LVSH16X84FNCR	24	SHUTTER LOUVERED W/CENTER RAIL SMOOTH
LVSH18X54FNB	24	SHUTTER LOUVERED SMOOTH
LVSH18X60FNB	24	SHUTTER LOUVERED SMOOTH
LVSH18X60FNCR	24	SHUTTER LOUVERED W/CENTER RAIL SMOOTH
LVSH18X66FNCR	24	SHUTTER LOUVERED W/CENTER RAIL SMOOTH
LVSH18X72FNB	24	SHUTTER LOUVERED SMOOTH

Part Number	Page	Description
LVSH18X72FNCR	24	SHUTTER LOUVERED W/CENTER RAIL SMOOTH
LVSH18X84FNCR	24	SHUTTER LOUVERED W/ CENTER RAIL SMOOTH
LVSH18X96FNCR	24	SHUTTER LOUVERED W/ CENTER RAIL SMOOTH
LVSH24X60FNB	24	SHUTTER LOUVERED SMOOTH
LVSH24X60FNCR	24	SHUTTER LOUVERED W/CENTER RAIL SMOOTH
LVSH24X72FNB	24	SHUTTER LOUVERED SMOOTH
LVSH24X72FNCR	24	SHUTTER LOUVERED W/CENTER RAIL SMOOTH

M

MC8X9X60	136	MANTEL CLASSIC SMOOTH
MC8X9X72	136	MANTEL CLASSIC SMOOTH
MLD1001-12	103	MOULDING CROWN SMOOTH
MLD1002-12	103	MOULDING CROWN SMOOTH
MLD1019-12	118	MOULDING BASE TRIM SMOOTH
MLD1020-12	118	MOULDING BASE TRIM SMOOTH
MLD1037-12	100	MOULDING CROWN SMOOTH
MLD205-12	121	MOULDING W&D CASING SMOOTH
MLD207-16	121	MOULDING W&D CASING FLUTED SMOOTH
MLD208-16	121	MOULDING W&D CASING FLUTED SMOOTH
MLD214-12	114	MOULDING W&D CASING SMOOTH
MLD215-12	127	MOULDING W&D CASING SMOOTH
MLD220-12	119	MOULDING W&D CASING SMOOTH
MLD220-16	119	MOULDING W&D CASING SMOOTH
MLD221-16	120	MOULDING W&D CASING SMOOTH
MLD224-12	118	MOULDING W&D CASING SMOOTH
MLD226-10	111	MOULDING W&D CASING SMOOTH
MLD226-12	111	MOULDING W&D CASING SMOOTH
MLD226-16	111	MOULDING W&D CASING SMOOTH

Part Number	Page	Description
MLD227-16	120	MOULDING W&D CASING SMOOTH
MLD230-16	118	MOULDING W&D CASING SMOOTH
MLD231-12	114	MOULDING W&D CASING SMOOTH
MLD234-16	114	MOULDING W&D CASING SMOOTH
MLD236-16	119	MOULDING W&D CASING SMOOTH
MLD237-16	118	MOULDING W&D CASING SMOOTH
MLD240-8	111	MOULDING CORNICE SMOOTH
MLD246-16	120	MOULDING FASCIA SMOOTH
MLD250-12	118	MOULDING W&D CASING SMOOTH
MLD250-8	118	MOULDING W&D CASING SMOOTH
MLD253-16	103	MOULDING CROWN FASCIA SMOOTH
MLD304-8	123	MOULDING DENTIL SMOOTH
MLD310-12	124	MOULDING DENTIL SMOOTH
MLD310-16	124	MOULDING DENTIL SMOOTH
MLD311-16	112	MOULDING CORNICE SMOOTH
MLD313-8	123	MOULDING DENTIL SMOOTH
MLD320-12	124	MOULDING DENTIL SMOOTH
MLD320-16	124	MOULDING DENTIL SMOOTH
MLD320-8	124	MOULDING DENTIL SMOOTH
MLD330-12	124	MOULDING DENTIL SMOOTH
MLD331-16	125	MOULDING DENTIL SMOOTH
MLD332-8	124	MOULDING DENTIL SMOOTH
MLD333-12	125	MOULDING DENTIL SMOOTH
MLD335-12	124	MOULDING DENTIL SMOOTH
MLD336-16	108	MOULDING DENTIL SMOOTH
MLD350-8	123	MOULDING DENTIL SMOOTH
MLD351-8	123	MOULDING DENTIL SMOOTH

Part Number	Page	Description
MLD352-8	124	MOULDING DENTIL SMOOTH
MLD353-8	124	MOULDING DENTIL SMOOTH
MLD354-12	123	MOULDING DENTIL SMOOTH
MLD355-8	123	MOULDING DENTIL SMOOTH
MLD360-8	124	MOULDING DENTIL SMOOTH
MLD362-16	108	MOULDING DENTIL SMOOTH
MLD365-16	108	MOULDING DENTIL SMOOTH
MLD370-8	125	MOULDING DENTIL SMOOTH
MLD371-16	104	MOULDING CROWN FASCIA SMOOTH
MLD404-16	108	MOULDING CROWN SMOOTH
MLD406-16	108	MOULDING CROWN SMOOTH
MLD410-12	108	MOULDING CROWN SMOOTH
MLD411-16	108	MOULDING CROWN SMOOTH
MLD412-16	109	MOULDING CROWN SMOOTH
MLD413-12	109	MOULDING CROWN SMOOTH
MLD419-12	109	MOULDING CROWN SMOOTH
MLD421-12	109	MOULDING CROWN SMOOTH
MLD425-12	110	MOULDING CROWN SMOOTH
MLD430-12	108	MOULDING CROWN SMOOTH
MLD434-16	125	MOULDING DENTIL SMOOTH
MLD435-16	109	MOULDING CROWN SMOOTH
MLD440-12	108	MOULDING CROWN SMOOTH
MLD449-16	103	MOULDING CROWN SMOOTH
MLD450-16	104	MOULDING CROWN SMOOTH
MLD451-16	98	MOULDING CROWN SMOOTH
MLD452-12	98	MOULDING CROWN SMOOTH
MLD453-16	100	MOULDING CROWN SMOOTH

Part Number	Page	Description
MLD454-12	98	MOULDING CROWN SMOOTH
MLD456-16	98	MOULDING CROWN SMOOTH
MLD457-12	103	MOULDING CROWN SMOOTH
MLD460-12	99	MOULDING CROWN SMOOTH
MLD461-8	109	MOULDING CROWN SMOOTH
MLD467-16	99	MOULDING CROWN SMOOTH
MLD472-12	113	MOULDING CROWN SMOOTH
MLD481-12	107	MOULDING CROWN SMOOTH
MLD505-8	112	MOULDING FASCIA SMOOTH
MLD506-16	113	MOULDING FASCIA SMOOTH
MLD508-12	112	MOULDING FASCIA SMOOTH
MLD509-16	111	MOULDING CORNICE SMOOTH
MLD510-12	111	MOULDING CORNICE SMOOTH
MLD511-12	111	MOULDING CORNICE SMOOTH
MLD512-16	112	MOULDING CORNICE SMOOTH
MLD513-16	111	MOULDING FASCIA SMOOTH
MLD520-16	112	MOULDING CORNICE SMOOTH
MLD521-8	112	MOULDING FASCIA SMOOTH
MLD522-16	120	MOULDING FASCIA SMOOTH
MLD523-16	111	MOULDING FASCIA SMOOTH
MLD524-16	106	MOULDING CROWN FASCIA SMOOTH
MLD527-16	112	MOULDING CORNICE SMOOTH
MLD528-12	106	MOULDING CROWN SMOOTH
MLD530-8	120	MOULDING FASCIA SMOOTH
MLD531-8	120	MOULDING FASCIA SMOOTH
MLD533-12	113	MOULDING FASCIA SMOOTH
MLD534-12	113	MOULDING CORNICE SMOOTH

Part Number	Page	Description
MLD536-12	106	MOULDING CROWN FASCIA SMOOTH
MLD539-16	106	MOULDING CROWN FASCIA SMOOTH
MLD543-12	113	MOULDING FASCIA SMOOTH
MLD547-16	112	MOULDING CORNICE SMOOTH
MLD548-16	111	MOULDING FASCIA SMOOTH
MLD552-12	98	MOULDING CROWN FASCIA SMOOTH
MLD555-12	104	MOULDING CROWN SMOOTH
MLD556-16	106	MOULDING CROWN FASCIA SMOOTH
MLD569-12	103	MOULDING CROWN FASCIA SMOOTH
MLD570-12	100	MOULDING CROWN FASCIA SMOOTH
MLD572-16	98	MOULDING CROWN SMOOTH
MLD580-12	106	MOULDING CROWN FASCIA SMOOTH
MLD582-12	103	MOULDING CROWN SMOOTH
MLD583-16	103	MOULDING COVE SMOOTH
MLD584-16	99	MOULDING COVE SMOOTH
MLD585-12	107	MOULDING CROWN FASCIA SMOOTH
MLD586-16	106	MOULDING CROWN FASCIA SMOOTH
MLD587-16	100	MOULDING CROWN FASCIA SMOOTH
MLD588-16	104	MOULDING COVE SMOOTH
MLD589-16	100	MOULDING COVE SMOOTH
MLD590-16	100	MOULDING COVE SMOOTH
MLD591-16	104	MOULDING COVE SMOOTH
MLD592-16	98	MOULDING COVE SMOOTH
MLD593-16	98	MOULDING COVE SMOOTH
MLD600-10	110	MOULDING FASCIA SMOOTH
MLD601-12	115	MOULDING OGEE SMOOTH
MLD603-8	126	MOULDING QUARTER ROUND SMOOTH

Part Number	Page	Description
MLD605-12	127	MOULDING HALF ROUND SMOOTH
MLD606-12	100	MOULDING COVE SMOOTH
MLD607-8	126	MOULDING CORNER STRIP SMOOTH
MLD611-12	116	MOULDING CHAIR RAIL SMOOTH
MLD612-12	115	MOULDING CHAIR RAIL SMOOTH
MLD613-12	116	MOULDING BED MOULDING SMOOTH
MLD614-16	116	MOULDING CHAIR RAIL SMOOTH
MLD618-16	115	MOULDING BASE CAP SMOOTH
MLD621-16	118	MOULDING SHINGLE SMOOTH
MLD626-8	115	MOULDING BED MOULDING SMOOTH
MLD627-16	115	MOULDING CHAIR RAIL SMOOTH
MLD628-8	126	MOULDING COVE SMOOTH
MLD629-10	116	MOULDING BED MOULDING SMOOTH
MLD631-16	116	MOULDING CHAIR RAIL SMOOTH
MLD633-8	115	MOULDING OGEE SMOOTH
MLD634-16	115	MOULDING OGEE SMOOTH
MLD635-12	104	MOULDING COVE SMOOTH
MLD637-16	114	MOULDING ASTRAGAL/MULLION SMOOTH
MLD639-16	120	MOULDING FASCIA SMOOTH
MLD640-8	110	MOULDING FASCIA SMOOTH
MLD641-16	118	MOULDING CORNICE SMOOTH
MLD644-16	120	MOULDING FASCIA SMOOTH
MLD649-16	115	MOULDING BED MOULDING SMOOTH
MLD660-10	126	MOULDING COVE SMOOTH
MLD710-10	114	MOULDING SILL SMOOTH
MLD715-16	118	MOULDING FLAT TRIM PROFILES BEADED SMOOTH
MLD734-12	106	MOULDING COVE SMOOTH

Part Number	Page	Description
MLDWM180-8	95	BRICKMOULD SMOOTH
MLDWM182-12	95	BRICKMOULD SMOOTH
MS8X9X60	134	MANTEL STEPPED SMOOTH
MS8X9X72	134	MANTEL STEPPED SMOOTH
MTLINSTALLKIT	155	MANTEL INSTALLATION KIT

N

NP10X48	270, 272	NEWEL POST DECO EDGE SMOOTH
NP6X48	270, 272	NEWEL POST PLAIN SMOOTH
NP8X48	270, 272	NEWEL POST PLAIN SMOOTH
NPCP13X48	271, 272	CORNER PANEL NEWEL POST SMOOTH
NPCP8X48	271, 272	CORNER PANEL NEWEL POST SMOOTH
NPK10	270, 271	NEWEL POST INSTALL KIT
NPK13	270, 271	NEWEL POST INSTALL KIT SMOOTH
NPK400	270, 271	NEWEL POST INSTALL KIT SMOOTH
NPK600	270, 271	NEWEL POST INSTALL KIT SMOOTH
NPSP13X48	270, 272	STRAIGHT PANEL NEWEL POST SMOOTH
NPSP8X48	270, 272	STRAIGHT PANEL NEWEL POST SMOOTH

O

OLV18	227	OCTAGON LOUVER DECO SMOOTH
OLV22	227	OCTAGON LOUVER DECO SMOOTH
OLV24	227	OCTAGON LOUVER DECO SMOOTH
OLV28	227	OCTAGON LOUVER DECO SMOOTH
OV24X36X4F	87	TRIM OVAL FLAT SMOOTH
OV24X36X4M	87	TRIM OVAL DECORATIVE SMOOTH
OVL28X35K215V	225	LOUVER DECO OVAL VRTCL W/ DC TRIM & KEY SMOOTH
OVL35X28K215	225	LOUVER DECO OVAL HORZ W/ DC TRIM & KEY SMOOTH
OVLV18X24V	225	OVAL VERTICAL LOUVER DECO SMOOTH

Part Number	Page	Description
OVLV20X29VTK	225	LOUVER DECO OVAL VRTCL W/ FL TRIM & KEY SMOOTH

P

PB2.5X2.5	127	PLINTH BLOCK ROSETTE SMOOTH
PB3.5X3.5	127	PLINTH BLOCK ROSETTE SMOOTH
PB3.875X3.875	127	PLINTH BLOCK ROSETTE SMOOTH
PB3X3	127	PLINTH BLOCK ROSETTE SMOOTH
PB4X4	127	PLINTH BLOCK ROSETTE SMOOTH
PB5X5	127	PLINTH BLOCK ROSETTE SMOOTH
PB6X6	127	PLINTH BLOCK ROSETTE SMOOTH
PCP56	73	PEDIMENT PEAKED CAP SMOOTH
PHFR5X11	209	FINIAL FULL RND PINEAPPLE SMOOTH
PHFR6X14	209	FINIAL FULL RND PINEAPPLE SMOOTH
PIL10X120P	78	PILASTER PLAIN ADJ PLTH SMOOTH
PIL10X192A	84	PILASTER ARCH PROF SMOOTH
PIL10X96HC	84	PILASTER HALF RND ADJ CLM SMOOTH
PIL11X108	82	PILASTER FLUTED ADJ PLTH SMOOTH
PIL11X108DP	80	PILASTER DOUBLE PANEL MLD PLTH SMOOTH
PIL11X108P	78	PILASTER PLAIN ADJ PLTH SMOOTH
PIL11X120	82	PILASTER FLUTED ADJ PLTH SMOOTH
PIL11X120P	78	PILASTER PLAIN ADJ PLTH SMOOTH
PIL11X144	82	PILASTER FLUTED ADJ PLTH SMOOTH
PIL11X90	81	PILASTER FLUTED MLD PLTH SMOOTH
PIL11X90DP	80	PILASTER DOUBLE PANEL MLD PLTH SMOOTH
PIL11X90P	78	PILASTER PLAIN MLD PLTH SMOOTH
PIL11X96P	78	PILASTER PLAIN ADJ PLTH SMOOTH
PIL3X108	82	PILASTER FLUTED ADJ PLTH SMOOTH
PIL4X108	82	PILASTER FLUTED ADJ PLTH SMOOTH

Part Number	Page	Description
PIL4X83	81	PILASTER FLUTED MLD PLTH SMOOTH
PIL4X86	81	PILASTER FLUTED MLD PLTH SMOOTH
PIL4X90	81	PILASTER FLUTED MLD PLTH SMOOTH
PIL5X108	82	PILASTER FLUTED ADJ PLTH SMOOTH
PIL5X108P	78	PILASTER PLAIN ADJ PLTH SMOOTH
PIL5X120E	82	PILASTER FLUTED ECO ADJ PLTH SMOOTH
PIL5X82	81	PILASTER FLUTED MLD PLTH SMOOTH
PIL5X90	81	PILASTER FLUTED MLD PLTH SMOOTH
PIL5X90DP	80	PILASTER DOUBLE PANEL MLD PLTH SMOOTH
PIL5X90E	80	PILASTER FLUTED ECO MLD PLTH SMOOTH
PIL5X90P	78	PILASTER PLAIN MLD PLTH SMOOTH
PIL6X108	82	PILASTER FLUTED ADJ PLTH SMOOTH
PIL6X120P	78	PILASTER PLAIN ADJ PLTH SMOOTH
PIL6X144	82	PILASTER FLUTED ADJ PLTH SMOOTH
PIL6X90	81	PILASTER FLUTED MLD PLTH SMOOTH
PIL6X90P	78	PILASTER PLAIN MLD PLTH SMOOTH
PIL7X102	82	PILASTER FLUTED ADJ PLTH SMOOTH
PIL7X108	82	PILASTER FLUTED ADJ PLTH SMOOTH
PIL7X108P	78	PILASTER PLAIN ADJ PLTH SMOOTH
PIL7X120P	78	PILASTER PLAIN ADJ PLTH SMOOTH
PIL7X144	82	PILASTER FLUTED ADJ PLTH SMOOTH
PIL7X90	81	PILASTER FLUTED MLD PLTH SMOOTH
PIL7X90DP	80	PILASTER DOUBLE PANEL MLD PLTH SMOOTH
PIL7X90DPE	80	PILASTER DOUBLE PANEL ECO MLD PLTH SMOOTH
PIL7X90E	80	PILASTER FLUTED ECO MLD PLTH SMOOTH
PIL7X90P	78	PILASTER PLAIN MLD PLTH SMOOTH
PIL8X108	82	PILASTER FLUTED ADJ PLTH SMOOTH

Part Number	Page	Description
PIL8X108P	78	PILASTER PLAIN ADJ PLTH SMOOTH
PIL8X144	82	PILASTER FLUTED ADJ PLTH SMOOTH
PIL8X90	82	PILASTER FLUTED ADJ PLTH SMOOTH
PIL8X90P	78	PILASTER PLAIN MLD PLTH SMOOTH
PIL9X100DP	80	PILASTER DOUBLE PANEL MLD PLTH SMOOTH
PIL9X102	82	PILASTER FLUTED ADJ PLTH SMOOTH
PIL9X108	82	PILASTER FLUTED ADJ PLTH SMOOTH
PIL9X108P	78	PILASTER PLAIN ADJ PLTH SMOOTH
PIL9X120P	78	PILASTER PLAIN ADJ PLTH SMOOTH
PIL9X144	82	PILASTER FLUTED ADJ PLTH SMOOTH
PIL9X90	81	PILASTER FLUTED MLD PLTH SMOOTH
PIL9X90DP	80	PILASTER DOUBLE PANEL MLD PLTH SMOOTH
PIL9X90E	80	PILASTER FLUTED ECO MLD PLTH SMOOTH
PIL9X90P	78	PILASTER PLAIN MLD PLTH SMOOTH
PLV18X24-8	215	PEAKED LOUVER DECO SMOOTH
PLV18X36-10	215	PEAKED LOUVER DECO SMOOTH
PLV24X30-10	215	PEAKED LOUVER DECO SMOOTH
PLV24X36-10	215	PEAKED LOUVER DECO SMOOTH
PLV24X36-12	215	PEAKED LOUVER DECO SMOOTH
PP5X102	275	PORCH POST COLONIAL SMOOTH
PP6X108	275	PORCH POST COLONIAL SMOOTH
PP6X120	275	PORCH POST COLONIAL SMOOTH
PP6X96	275	PORCH POST COLONIAL SMOOTH
PP8X120A	274	PORCH POST COLONIAL SMOOTH
PPSQKIT6X108S	277	COLUMN, TIMBER TEXTURE
PRS48X8	274	PORCH SPANDREL SMOOTH
PRS96X8	274	PORCH SPANDREL SMOOTH

Part Number	Page	Description
PST10X10F	270, 271, 272	NEWEL POST FLAT POST CAP SMOOTH
PST11X11FP	270, 272	NEWEL POST FANCY PEAKED CAP SMOOTH
PST13X13FP	270, 271, 272	NEWEL POST FANCY PEAKED POST CAP SMOOTH
PST14X14F	270, 271, 272	NEWEL POST FLAT POST CAP SMOOTH
PST6X6FP	270, 272	NEWEL POST FANCY PEAKED POST CAP SMOOTH
PST7X7F	270, 272	NEWEL POST FLAT POST CAP SMOOTH
PST8X8FP	270, 272	NEWEL POST FANCY PEAKED POST CAP SMOOTH
PST9X9FP	270, 271, 272	NEWEL POST FANCY PEAKED POST CAP SMOOTH
R		
RLV12	222	LOUVER DECO ROUND SMOOTH
RLV16	222	LOUVER DECO ROUND SMOOTH
RLV16MTK	223	LOUVER DECO ROUND W/ DC TRIM & KEY SMOOTH
RLV18	222	LOUVER DECO ROUND SMOOTH
RLV18MTK	223	LOUVER DECO ROUND W/ DC TRIM & KEY SMOOTH
RLV18X4F	222	TRIM ROUND SMOOTH
RLV24	222	LOUVER DECO ROUND SMOOTH
RLV24-4FTK	223	LOUVER DECO ROUND W/ FL TRIM & KEY SMOOTH
RLV24-6TK	223	LOUVER FUNC ROUND W/ FL TRIM & FLAT KEY SMOOTH
RLV24MTK	223	LOUVER DECO ROUND W/ DC TRIM & KEY SMOOTH
RLV24TK	224	LOUVER DECO ROUND W/ FL TRIM & KEY SMOOTH
RLV24X4F	222	TRIM ROUND SMOOTH
RLV28	222	LOUVER DECO ROUND SMOOTH
RLV28X4F	222	TRIM ROUND SMOOTH
RLV30	222	LOUVER DECO ROUND SMOOTH
RLV30-6TK	223	LOUVER DECO ROUND W/ FL TRIM & KEY SMOOTH
RLV30MTK	223	LOUVER DECO ROUND W/ DC TRIM & KEY SMOOTH
RLV30TK	224	LOUVER DECO ROUND W/ FL TRIM & KEY SMOOTH

Part Number	Page	Description
RLV32-2F	222	LOUVER DECO ROUND W/ FL TRIM SMOOTH
RLV32MTK	223	LOUVER DECO ROUND W/ DC TRIM & KEY SMOOTH
RLV36	222	LOUVER DECO ROUND SMOOTH
RLV36TK	224	LOUVER DECO ROUND W/ FL TRIM & KEY SMOOTH
RLV40MTK	223	LOUVER DECO ROUND W/ DC TRIM & KEY SMOOTH
RLV42	222	LOUVER DECO ROUND SMOOTH
RLV48	222	LOUVER DECO ROUND SMOOTH
RSB4X4X6	266, 268	BAULSTER RAIL SUPPORT BLOCK SMOOTH
S		
S4X21	208	SPIRE SMOOTH
S6X32	208	SPIRE SMOOTH
SH16X72DP	27	SHUTTER RAISED PANEL DOUBLE SMOOTH
SH16X84DP	27	SHUTTER RAISED PANEL DOUBLE SMOOTH
SH16X96DP	27	SHUTTER RAISED PANEL DOUBLE SMOOTH
SH18X53DP	27	SHUTTER RAISED PANEL DOUBLE SMOOTH
SH18X59DP	27	SHUTTER RAISED PANEL DOUBLE SMOOTH
SH18X66DP	27	SHUTTER RAISED PANEL DOUBLE SMOOTH
SH18X72DP	27	SHUTTER RAISED PANEL DOUBLE SMOOTH
SH18X80DP	27	SHUTTER RAISED PANEL DOUBLE SMOOTH
SH18X84DP	27	SHUTTER RAISED PANEL DOUBLE SMOOTH
SH18X96DP	27	SHUTTER RAISED PANEL DOUBLE SMOOTH
SH24X66DP	27	SHUTTER RAISED PANEL DOUBLE SMOOTH
SH2FP12X	31	SHAKER SHUTTER
SH2FP16X	31	SHAKER SHUTTER
SH2FP18X	31	SHAKER SHUTTER
SH2FP24X	31	SHAKER SHUTTER
SH2P3B12X_RS	48	PLANK SHUTTER 2 BOARD AND 3 BATTEN, ROUGH SAWN WOODGRAIN

Part Number	Page	Description
SH2P3BC12X_RS	39	B&B SHUTTER 2 BOARD AND 3 BATTEN, ROUGH SAWN WOODGRAIN
SH2PC12X_RS	36	B&B SHUTTER 2 BOARD AND 2 BATTEN, ROUGH SAWN WOODGRAIN
SH2PD12X_RS	50	PLANK SHUTTER W/DIAMOND 2 BOARD AND 2 BATTEN, ROUGH SAWN
SH2PEBC12X_RS	40	B&B SHUTTER 2 BOARD AND END BATTEN, ROUGH SAWN WOODGRAIN
SH2PHLR12X_RS	44	B&B SHUTTER ARCH TOP 2 BOARD AND 2 BATTEN, ROUGH SAWN
SH2PO12X_RS	46	PLANK SHUTTER 2 BOARD AND 2 BATTEN, ROUGH SAWN WOODGRAIN
SH2PZ12X_RS	49	PLANK SHUTTER 2 BOARD AND Z-BATTEN, ROUGH SAWN WOODGRAIN
SH2PZC12X_RS	43	B&B SHUTTER 2 BOARD AND Z-BATTEN, ROUGH SAWN WOODGRAIN
SH3P3B18X_RS	48	PLANK SHUTTER 3 BOARD AND 3 BATTEN, ROUGH SAWN WOODGRAIN
SH3P3BC14X_RS	39	B&B SHUTTER 3 BOARD AND 3 BATTEN, ROUGH SAWN WOODGRAIN
SH3P3BC18X_RS	39	B&B SHUTTER 3 BOARD AND 3 BATTEN, ROUGH SAWN WOODGRAIN
SH3PC14X_RS	36	B&B SHUTTER 3 BOARD AND 2 BATTEN, ROUGH SAWN WOODGRAIN
SH3PC18X_RS	36	B&B SHUTTER 3 BOARD AND 2 BATTEN, ROUGH SAWN WOODGRAIN
SH3PD18X_RS	50	PLANK SHUTTER W/DIAMOND 3 BOARD AND 2 BATTEN, ROUGH SAWN
SH3PEBC14X_RS	40	B&B SHUTTER 3 BOARD AND END BATTEN, ROUGH SAWN WOODGRAIN
SH3PEBC18X_RS	40	B&B SHUTTER 3 BOARD AND END BATTEN, ROUGH SAWN WOODGRAIN
SH3PEHLR18X_X_RS	45	B&B ELLIPTICAL SHUTTER 3 BOARD, ROUGH SAWN
SH3PHLR14X_RS	44	B&B SHUTTER ARCH TOP 3 BOARD AND 2 BATTEN, ROUGH SAWN
SH3PHLR18X_RS	44	B&B SHUTTER ARCH TOP 3 BOARD AND 2 BATTEN, ROUGH SAWN
SH3PO18X_RS	46	PLANK SHUTTER 3 BOARD AND 2 BATTEN, ROUGH SAWN WOODGRAIN
SH3PZ18X_RS	49	PLANK SHUTTER 3 BOARD AND Z-BATTEN, ROUGH SAWN WOODGRAIN
SH3PZC14X_RS	43	B&B SHUTTER 3 BOARD AND Z-BATTEN, ROUGH SAWN WOODGRAIN
SH3PZC18X_RS	43	B&B SHUTTER 3 BOARD AND Z-BATTEN, ROUGH SAWN WOODGRAIN
SH4P3B24X_RS	48	PLANK SHUTTER 4 BOARD AND 3 BATTEN, ROUGH SAWN WOODGRAIN
SH4P3BC24X_RS	39	B&B SHUTTER 4 BOARD AND 3 BATTEN, ROUGH SAWN WOODGRAIN
SH4PC24X_RS	36	B&B SHUTTER 4 BOARD AND 2 BATTEN, ROUGH SAWN WOODGRAIN
SH4PD24X_RS	50	PLANK SHUTTER W/DIAMOND 4 BOARD AND 2 BATTEN, ROUGH SAWN

Part Number	Page	Description
SH4PEBC24X_RS	40	B&B SHUTTER 4 BOARD AND END BATTEN, ROUGH SAWN WOODGRAIN
SH4PHLR24X_RS	44	B&B SHUTTER ARCH TOP 4 BOARD AND 2 BATTEN, ROUGH SAWN
SH4PO24X_RS	46	PLANK SHUTTER 4 BOARD AND 2 BATTEN, ROUGH SAWN WOODGRAIN
SH4PZ24X_RS	48	PLANK SHUTTER 4 BOARD AND Z-BATTEN, ROUGH SAWN WOODGRAIN
SH4PZC24X_RS	43	B&B SHUTTER 4 BOARD AND Z-BATTEN, ROUGH SAWN WOODGRAIN
SHBB14X144RS	53	SHUTTER BOARD 3 BOARD, WOODGRAIN
SHBB18X144RS	53	SHUTTER BOARD 3 BOARD, WOODGRAIN
SHHNGSPR10	53	SHUTTER HINGE SPEAR STYLE
SHHNGSPR16	53	SHUTTER HINGE SPEAR STYLE
SHMFH12X	28	SHAKER MODERN FARMHOUSE SHUTTER
SHMFH16X	28	SHAKER MODERN FARMHOUSE SHUTTER
SHMFH18X	28	SHAKER MODERN FARMHOUSE SHUTTER
SHMFH24X	28	SHAKER MODERN FARMHOUSE SHUTTER
SHSFP12X144	32	SHAKER SHUTTER BOARDS 12X144 SMOOTH
SHSFP16X144	32	SHAKER SHUTTER BOARDS 16X144 SMOOTH
SHSFP18X144	32	SHAKER SHUTTER BOARDS 18X144 SMOOTH
SHSFP24X144	32	SHAKER SHUTTER BOARDS 24X144 SMOOTH
SP56	70	PEDIMENT SUNBURST SMOOTH
SP667	70	PEDIMENT SUNBURST SMOOTH
SP91	70	PEDIMENT SUNBURST SMOOTH
SWDH24X12	69	PEDIMENT HALF ROUND SUNBURST SMOOTH
SWDH28X14	69	PEDIMENT HALF ROUND SUNBURST SMOOTH
SWDH30X15	69	PEDIMENT HALF ROUND SUNBURST SMOOTH
SWDH32X16	69	PEDIMENT HALF ROUND SUNBURST SMOOTH
SWDH33X17	69	PEDIMENT HALF ROUND SUNBURST SMOOTH
SWDH36X18	69	PEDIMENT HALF ROUND SUNBURST SMOOTH
SWDH36X18-4FK	69	PEDIMENT HALF RND SUNBURST W/FLT TRIM & KEY SMOOTH

Part Number	Page	Description
SWDH36X9	68	PEDIMENT SEGMENT SUNBURST SMOOTH
SWDH37X19	69	PEDIMENT HALF ROUND SUNBURST SMOOTH
SWDH40X20	69	PEDIMENT HALF ROUND SUNBURST SMOOTH
SWDH42X21	69	PEDIMENT HALF ROUND SUNBURST SMOOTH
SWDH44X22	69	PEDIMENT HALF ROUND SUNBURST SMOOTH
SWDH48X13	68	PEDIMENT SEGMENT SUNBURST SMOOTH
SWDH48X24	69	PEDIMENT HALF ROUND SUNBURST SMOOTH
SWDH56X28	69	PEDIMENT HALF ROUND SUNBURST SMOOTH
SWDH60X30	69	PEDIMENT HALF ROUND SUNBURST SMOOTH
SWDH64X32	69	PEDIMENT HALF ROUND SUNBURST SMOOTH
SWDH68X14	68	PEDIMENT SEGMENT SUNBURST SMOOTH
SWDH68X34	69	PEDIMENT HALF ROUND SUNBURST SMOOTH
SWDH72X14	68	PEDIMENT SEGMENT SUNBURST SMOOTH
SWDH72X36	69	PEDIMENT HALF ROUND SUNBURST SMOOTH
SWDH76X15	68	PEDIMENT SEGMENT SUNBURST SMOOTH
SWDH76X38	69	PEDIMENT HALF ROUND SUNBURST SMOOTH
SWDH80X15	68	PEDIMENT SEGMENT SUNBURST SMOOTH

T

TC6	270, 272	NEWEL POST TRIM COLLAR SMOOTH
TC8	270, 272	NEWEL POST TRIM COLLAR SMOOTH
TC8-8	270, 272	NEWEL POST TRIM COLLAR SMOOTH
TRLS18987	204	TRELLIS KIT, TIMBER TEXTURE
TRLS18988	204	TRELLIS KIT, TIMBER TEXTURE
TRLS19003	202	TRELLIS KIT SMOOTH
TRLS19004	202	TRELLIS KIT SMOOTH
TRLV36X18	226	TRIANGLE LOUVER DECO SMOOTH
TRLV42X21	226	TRIANGLE LOUVER DECO SMOOTH

Part Number	Page	Description
TRLV48X12	226	TRIANGLE LOUVER DECO SMOOTH
TRLV48X18	226	TRIANGLE LOUVER DECO SMOOTH
TRLV48X22	226	TRIANGLE LOUVER DECO SMOOTH
TRLV48X24	226	TRIANGLE LOUVER DECO SMOOTH
TRLV60X18	226	TRIANGLE LOUVER DECO SMOOTH
TRLV60X23	226	TRIANGLE LOUVER DECO SMOOTH
TRLV60X25	226	TRIANGLE LOUVER DECO SMOOTH
TRLV60X30	226	TRIANGLE LOUVER DECO SMOOTH
TRLV64X27	226	TRIANGLE LOUVER DECO SMOOTH
TRLV64X32	226	TRIANGLE LOUVER DECO SMOOTH
TRLV66X22	226	TRIANGLE LOUVER DECO SMOOTH
TRLV72X36	226	TRIANGLE LOUVER DECO SMOOTH
TRLV76X19	226	TRIANGLE LOUVER DECO SMOOTH
TRLV84X18	226	TRIANGLE LOUVER DECO SMOOTH
TRLV84X21	226	TRIANGLE LOUVER DECO SMOOTH
TRLV88X22	226	TRIANGLE LOUVER DECO SMOOTH
TRLVLR108X27	227	2PC TRIANGLE LOUVER DECO SMOOTH
TRLVLR115X35	227	2PC TRIANGLE LOUVER DECO SMOOTH
TRLVLR120X30	227	2PC TRIANGLE LOUVER DECO SMOOTH
TRLVLR60X25	227	2PC TRIANGLE LOUVER DECO SMOOTH
TRLVLR60X30	227	2PC TRIANGLE LOUVER DECO SMOOTH

W

WCH100X6	61	CROSSHEAD SMOOTH
WCH100X9	63	CROSSHEAD SMOOTH
WCH101X9	63	CROSSHEAD SMOOTH
WCH102X12	65	CROSSHEAD SMOOTH
WCH103X6	61	CROSSHEAD SMOOTH

Part Number	Page	Description
WCH103X9	63	CROSSHEAD SMOOTH
WCH104X12	65	CROSSHEAD SMOOTH
WCH104X6	61	CROSSHEAD SMOOTH
WCH104X9	63	CROSSHEAD SMOOTH
WCH108X6	61	CROSSHEAD SMOOTH
WCH108X9	63	CROSSHEAD SMOOTH
WCH110X6	61	CROSSHEAD SMOOTH
WCH110X9	63	CROSSHEAD SMOOTH
WCH112X9	63	CROSSHEAD SMOOTH
WCH113X9	63	CROSSHEAD SMOOTH
WCH120X9	63	CROSSHEAD SMOOTH
WCH124X9	63	CROSSHEAD SMOOTH
WCH144X12	65	CROSSHEAD SMOOTH
WCH144X6	61	CROSSHEAD SMOOTH
WCH144X9	63	CROSSHEAD SMOOTH
WCH192X9	63	CROSSHEAD SMOOTH
WCH196X9	63	CROSSHEAD SMOOTH
WCH197X9	63	CROSSHEAD SMOOTH
WCH200X12	65	CROSSHEAD SMOOTH
WCH200X9	63	CROSSHEAD SMOOTH
WCH203X12	65	CROSSHEAD SMOOTH
WCH204X9	63	CROSSHEAD SMOOTH
WCH207X9	63	CROSSHEAD SMOOTH
WCH20X9	62	CROSSHEAD SMOOTH
WCH213X12	65	CROSSHEAD SMOOTH
WCH24X6	61	CROSSHEAD SMOOTH

Part Number	Page	Description
WCH24X9	62	CROSSHEAD SMOOTH
WCH25X9	62	CROSSHEAD SMOOTH
WCH26X9	62	CROSSHEAD SMOOTH
WCH27X9	62	CROSSHEAD SMOOTH
WCH28X6	61	CROSSHEAD SMOOTH
WCH28X9	62	CROSSHEAD SMOOTH
WCH29X9	62	CROSSHEAD SMOOTH
WCH30X6	61	CROSSHEAD SMOOTH
WCH30X9	62	CROSSHEAD SMOOTH
WCH31X6	61	CROSSHEAD SMOOTH
WCH32X6	61	CROSSHEAD SMOOTH
WCH32X9	62	CROSSHEAD SMOOTH
WCH33X6	61	CROSSHEAD SMOOTH
WCH33X9	62	CROSSHEAD SMOOTH
WCH34X6	61	CROSSHEAD SMOOTH
WCH34X9	62	CROSSHEAD SMOOTH
WCH35X6	61	CROSSHEAD SMOOTH
WCH35X9	62	CROSSHEAD SMOOTH
WCH36X12	65	CROSSHEAD SMOOTH
WCH36X6	61	CROSSHEAD SMOOTH
WCH36X9	62	CROSSHEAD SMOOTH
WCH37X6	61	CROSSHEAD SMOOTH
WCH37X9	62	CROSSHEAD SMOOTH
WCH38X6	61	CROSSHEAD SMOOTH
WCH38X9	62	CROSSHEAD SMOOTH
WCH40X12	65	CROSSHEAD SMOOTH

Part Number	Page	Description
WCH40X6	61	CROSSHEAD SMOOTH
WCH40X9	62	CROSSHEAD SMOOTH
WCH41X6	61	CROSSHEAD SMOOTH
WCH41X9	62	CROSSHEAD SMOOTH
WCH42X9	62	CROSSHEAD SMOOTH
WCH43X6	61	CROSSHEAD SMOOTH
WCH43X9	62	CROSSHEAD SMOOTH
WCH44X12	65	CROSSHEAD SMOOTH
WCH44X6	61	CROSSHEAD SMOOTH
WCH44X9	62	CROSSHEAD SMOOTH
WCH45X9	62	CROSSHEAD SMOOTH
WCH46X6	61	CROSSHEAD SMOOTH
WCH46X9	62	CROSSHEAD SMOOTH
WCH47X6	61	CROSSHEAD SMOOTH
WCH48X12	65	CROSSHEAD SMOOTH
WCH48X6	61	CROSSHEAD SMOOTH
WCH48X9	62	CROSSHEAD SMOOTH
WCH49X9	62	CROSSHEAD SMOOTH
WCH50X6	61	CROSSHEAD SMOOTH
WCH50X9	62	CROSSHEAD SMOOTH
WCH51X6	61	CROSSHEAD SMOOTH
WCH52X6	61	CROSSHEAD SMOOTH
WCH54X12	65	CROSSHEAD SMOOTH
WCH54X6	61	CROSSHEAD SMOOTH
WCH54X9	62	CROSSHEAD SMOOTH
WCH56X12	65	CROSSHEAD SMOOTH

Part Number	Page	Description
WCH56X6	61	CROSSHEAD SMOOTH
WCH56X9	62	CROSSHEAD SMOOTH
WCH58X9	62	CROSSHEAD SMOOTH
WCH60X6	61	CROSSHEAD SMOOTH
WCH60X9	62	CROSSHEAD SMOOTH
WCH62X9	62	CROSSHEAD SMOOTH
WCH64X12	65	CROSSHEAD SMOOTH
WCH64X6	61	CROSSHEAD SMOOTH
WCH64X9	62	CROSSHEAD SMOOTH
WCH65X9	62	CROSSHEAD SMOOTH
WCH66X6	61	CROSSHEAD SMOOTH
WCH66X9	62	CROSSHEAD SMOOTH
WCH67X6	61	CROSSHEAD SMOOTH
WCH67X9	62	CROSSHEAD SMOOTH
WCH68X6	61	CROSSHEAD SMOOTH
WCH68X9	62	CROSSHEAD SMOOTH
WCH69X9	62	CROSSHEAD SMOOTH
WCH6ARS34X10	66	ARCHED CROSSHEAD SMOOTH
WCH6ARS34X10K	66	ARCHED CROSSHEAD W/KEY SMOOTH
WCH70X9	62	CROSSHEAD SMOOTH
WCH72X12	65	CROSSHEAD SMOOTH
WCH72X6	61	CROSSHEAD SMOOTH
WCH72X9	62	CROSSHEAD SMOOTH
WCH73X6	61	CROSSHEAD SMOOTH
WCH73X9	62	CROSSHEAD SMOOTH
WCH74X6	61	CROSSHEAD SMOOTH

Part Number	Page	Description
WCH74X9	62	CROSSHEAD SMOOTH
WCH75X9	62	CROSSHEAD SMOOTH
WCH76X6	61	CROSSHEAD SMOOTH
WCH76X9	62	CROSSHEAD SMOOTH
WCH77X9	62	CROSSHEAD SMOOTH
WCH78X6	61	CROSSHEAD SMOOTH
WCH78X9	62	CROSSHEAD SMOOTH
WCH79X6	61	CROSSHEAD SMOOTH
WCH80.5X6	61	CROSSHEAD SMOOTH
WCH80X6	61	CROSSHEAD SMOOTH
WCH80X9	62	CROSSHEAD SMOOTH
WCH81X9	62	CROSSHEAD SMOOTH
WCH82X9	62	CROSSHEAD SMOOTH
WCH84X6	61	CROSSHEAD SMOOTH
WCH84X9	62	CROSSHEAD SMOOTH
WCH85X9	62	CROSSHEAD SMOOTH
WCH86X6	61	CROSSHEAD SMOOTH
WCH86X9	62	CROSSHEAD SMOOTH
WCH87X6	61	CROSSHEAD SMOOTH
WCH88X9	62	CROSSHEAD SMOOTH
WCH90X9	62	CROSSHEAD SMOOTH
WCH93X9	63	CROSSHEAD SMOOTH
WCH96X12	65	CROSSHEAD SMOOTH
WCH96X6	61	CROSSHEAD SMOOTH
WCH96X9	63	CROSSHEAD SMOOTH

Part Number	Page	Description
WCH99X9	63	CROSSHEAD SMOOTH
WCHARS101X13	66	ARCHED CROSSHEAD SMOOTH
WCHARS108X19	66	ARCHED CROSSHEAD SMOOTH
WCHARS33X14	66	ARCHED CROSSHEAD SMOOTH
WCHARS36X13	66	ARCHED CROSSHEAD SMOOTH
WCHARS43X13	66	ARCHED CROSSHEAD SMOOTH
WCHARS54X16	66	ARCHED CROSSHEAD SMOOTH
WCHARS64X14	66	ARCHED CROSSHEAD SMOOTH
WCHARS68X12	66	ARCHED CROSSHEAD SMOOTH
WCHARS68X16	66	ARCHED CROSSHEAD SMOOTH
WCHARS72X13	66	ARCHED CROSSHEAD SMOOTH
WCHARS75X13	66	ARCHED CROSSHEAD SMOOTH
WCHARS80X15	66	ARCHED CROSSHEAD SMOOTH
WCHARS84X16	66	ARCHED CROSSHEAD SMOOTH
WCHARS89X13	66	ARCHED CROSSHEAD SMOOTH
WCHARS97X17	66	ARCHED CROSSHEAD SMOOTH
WCHSEG28X10	67	EYEBROW CROSSHEAD SMOOTH
WCHSEG30X10	67	EYEBROW CROSSHEAD SMOOTH
WCHSEG34X10	67	EYEBROW CROSSHEAD SMOOTH
WCHSEG36X10	67	EYEBROW CROSSHEAD SMOOTH
WCHSEG43X10	67	EYEBROW CROSSHEAD SMOOTH
WCHSEG44X10	67	EYEBROW CROSSHEAD SMOOTH
WCHSEG64X10	67	EYEBROW CROSSHEAD SMOOTH
WCHSEG72X10	67	EYEBROW CROSSHEAD SMOOTH
WDP36X18	88	WINDOW PANEL RAISED SMOOTH





TRIM • MOULDINGS • LOUVERS • COLUMN WRAPS • BALUSTRADES

FYPON

fypon.com

1.800.446.9373

1 Horizon Way
Deerfield, IL 60015



info@fypon.com

©2026 Fypon, LLC. All rights reserved. FYPON and the Fypon Logo are trademarks of Fypon, LLC. Fypon, LLC, and its parent company Therma-Tru Corp. are part of Fortune Brands Innovations, Inc. All trademarks are property of their respective owners. Loctite, PL Premium, is owned by Henkel IP & Holding GmbH.
Part #MAFYFLCAT2026 SHERIDAN/JAN 2026 O25-450000