



kirei

TESSELLATE CLOUDS

Acoustic Ceiling Solution

Create exceptional overhead spaces that capture excess sound with the dynamic triangular facets of the Tessellate Cloud. The patent pending Tessellate Cloud brings a unique geometric look that invites your choice of lighting for an even more functional piece. Available in over 35 colors with the option for Kirei Ink printing, the Tessellate Cloud brings visual drama and impressive noise reduction.

Product shown: Tessellate Clouds in Navy and Vanilla with Kirei Ink (Pine)

Specs

Style	Standard (diameter)	Height	Weight	SF/Unit
Cloud	33.25"	10.6"	8 lbs	4.99 SF

All specs refer to singular products and not multiples unless specified. Due to the nature of the material, cutting and fabrication process, minor dimensional variances may occur.

Designer Kirei/Michael DiTullo

Material 100% PET (60% post-consumer recycled content)

Fire Rating ASTM E84 Class A

Custom Options Available upon request

Lead Time Please refer to kireiusa.com for updated lead times.

VOC Emissions CDPH (CA 01350) Compliant
TVOC: <0.5 mg/m3



*Actual lead times are determined when the project goes into production and can change based on production schedule and all quantities, color and thicknesses being in stock at time of order. See [Kirei's Product Lead Time Disclosure](#) for more information.



Product Dimensions

Tessellate Cloud

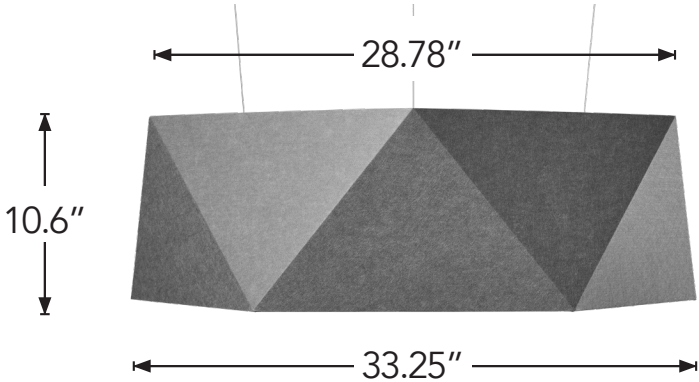

Side View

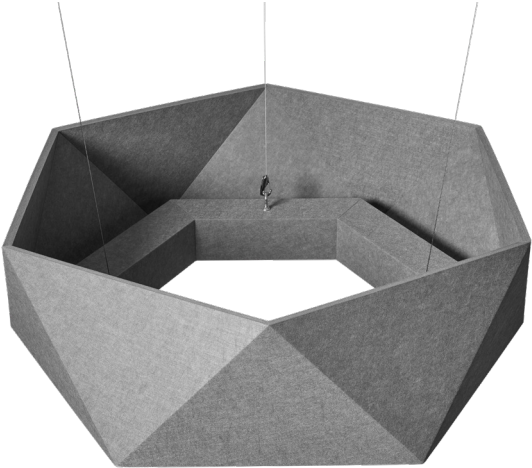

Top View

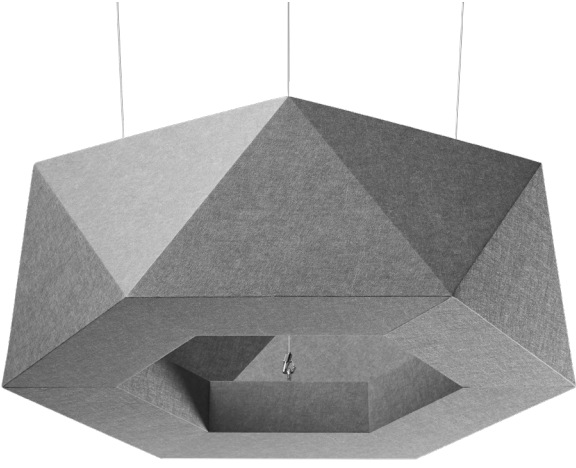

Bottom View

Acoustic Data - Tessellate Cloud

Sound Absorption

Frequency	125Hz	250Hz	500Hz	1000Hz	2000Hz	4000Hz	Array-NRC	Array-SAA
α array (Sabins/ft ²) (SA/m ²)	0.06	0.17	0.30	0.38	0.45	0.50	0.35	0.33

Sabins per Array

Frequency	125Hz	250Hz	500Hz	1000Hz	2000Hz	4000Hz
Sabins	7.85	22.33	39.36	50.91	60.52	66.66

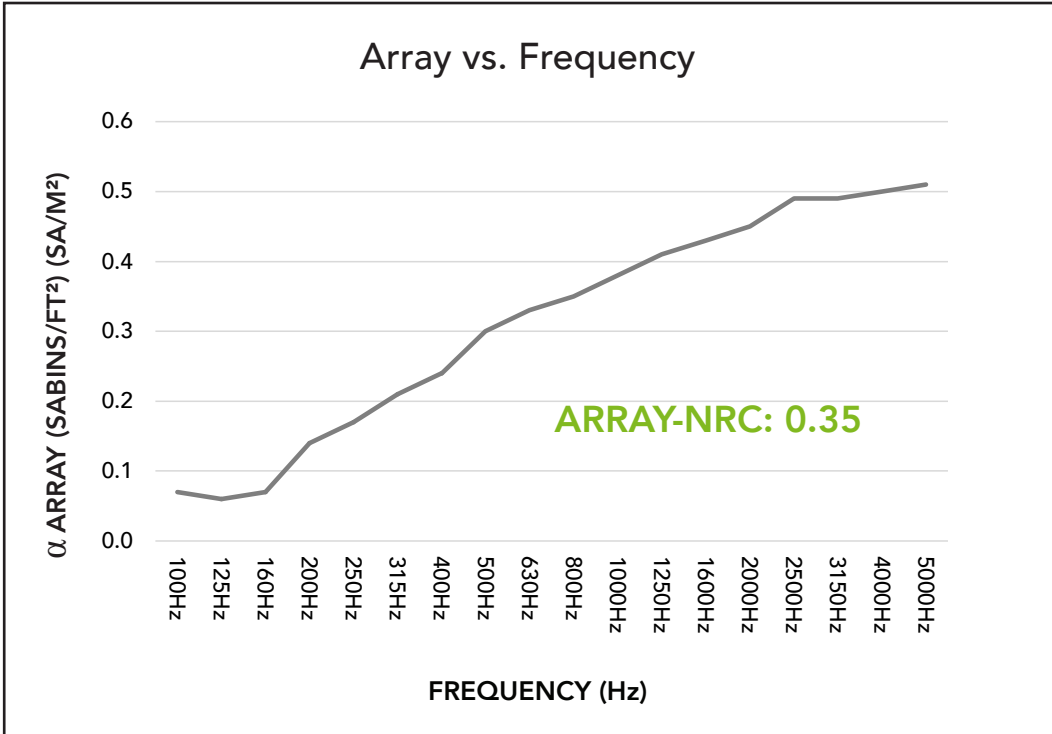

Acoustic data is measured in Array-NRC per Tessellate Cloud at four units, two rows of two units each, rows spaced 36" apart, units in each row spaced 36" apart. For more information, see the [full acoustic test](#).

Available Colors



Color variation between dye lots is a natural characteristic of recycled PET felt due to the manufacturing process. Slight differences between samples and finished product may occur.

Installation

Tessellate Clouds may be hung from a variety of ceiling types using cable suspension. Each cloud has three attachment points with pre-drilled holes in the cloud for 1/4"-20 male threaded screws or eyebolts. Fasten the hardware of your choice into the pre-drilled holes. Securely mount the appropriate ceiling hardware, attach cable to ceiling hardware, and then attach cable to hardware on baffle(s). For more information, see the [Tessellate Clouds Installation Guide](#).

Note: Kirei does not provide ceiling mounting hardware or cable/chain/rod.

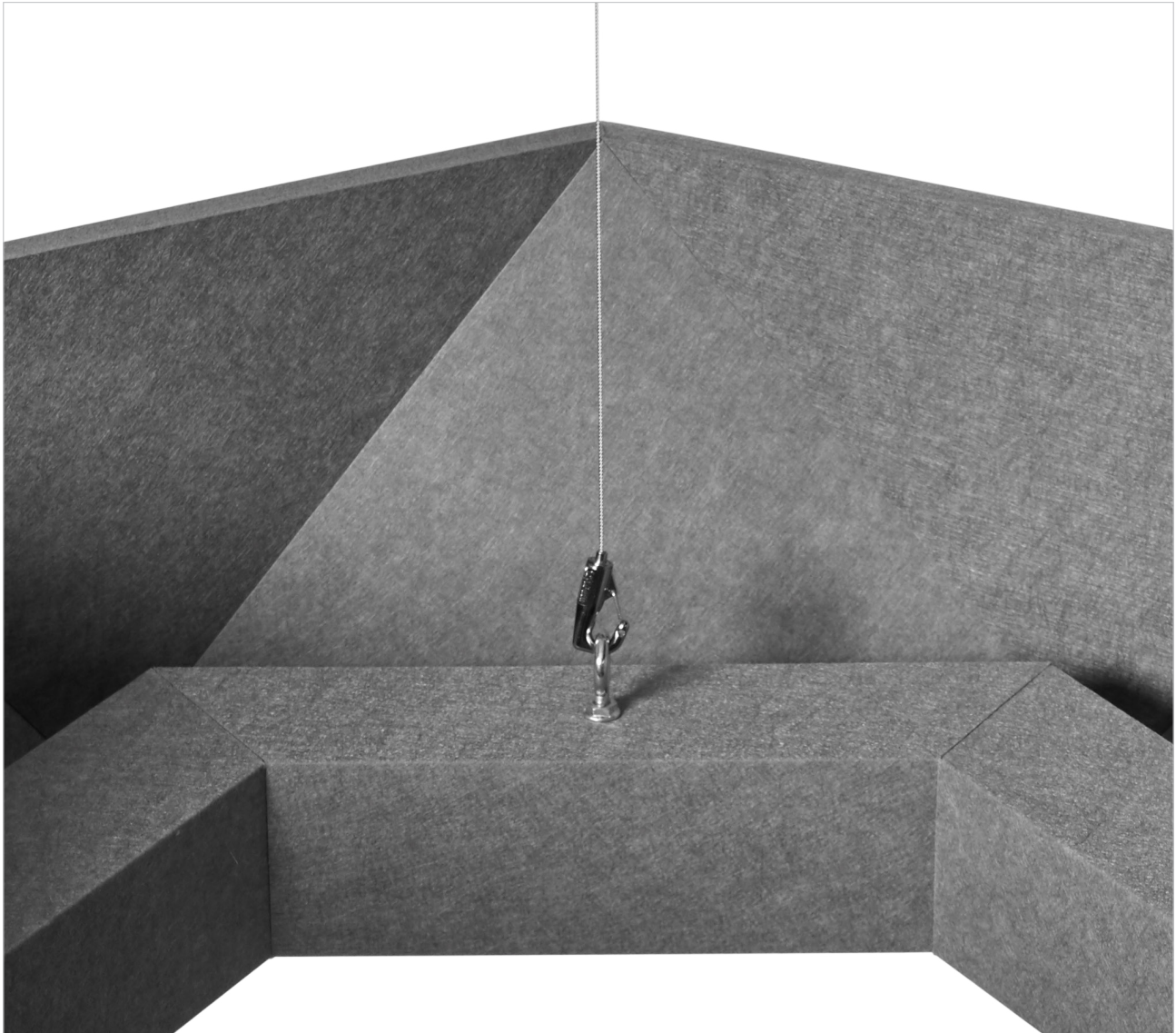

Eyebolt Hardware

Custom Printing with Kirei Ink

Tessellate Clouds can be custom printed in house with Kirei Ink. Deliver endless customization possibilities from the natural beauty of botanicals to subtle or striking stonework. Pick from more than 50 prints over Kirei Ink's four collections or print your own custom color, pattern, graphic or material. We would love to work with you. Reach out and our team will be ready to assist!

Please note: Kirei requires written permission from the copyright holder in order to reproduce any copyrighted work. Professional photographs cannot be reproduced without written permission from the photographer. Keep in mind printing is not on the edges of the fully assembled product.

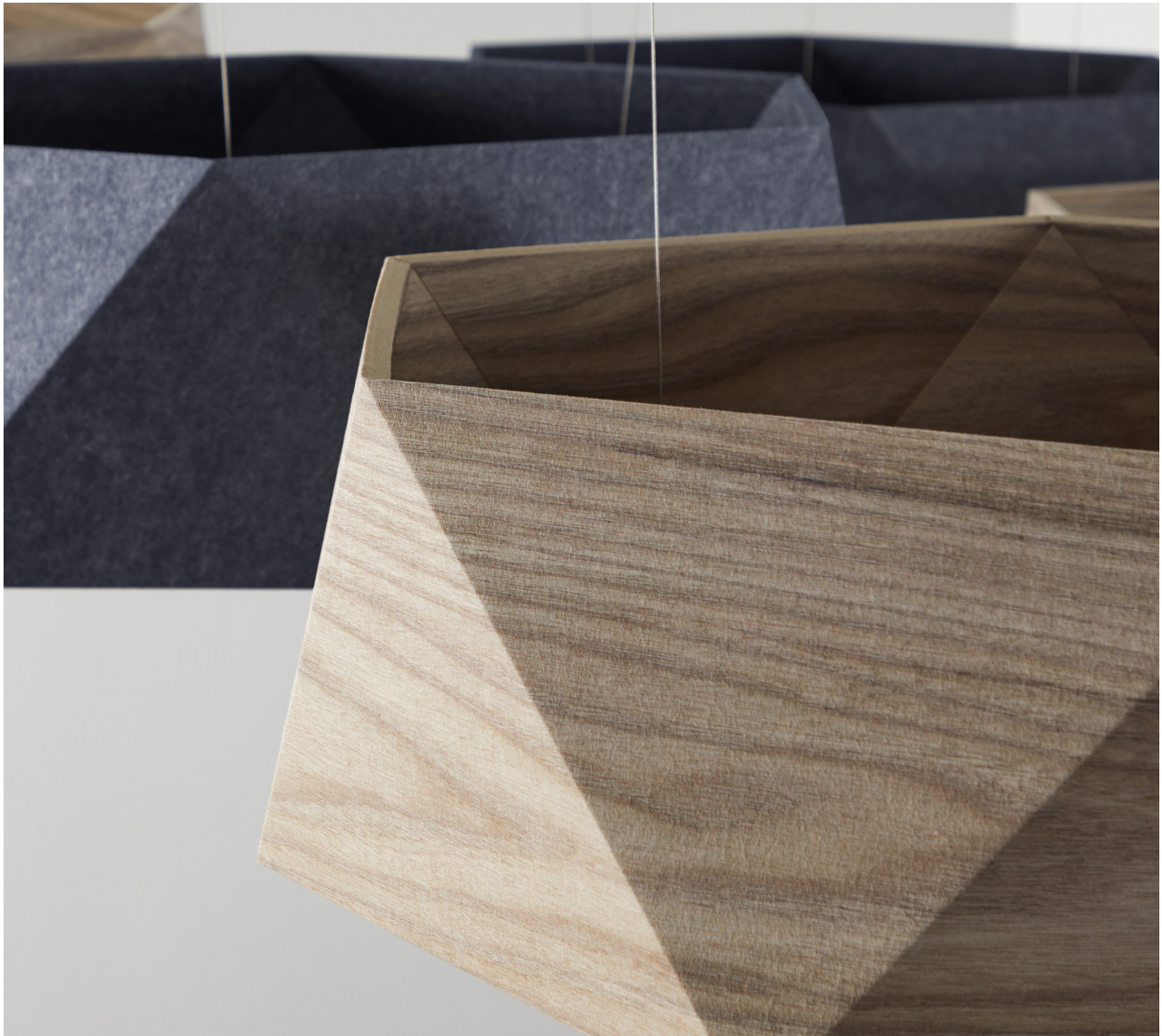

Product shown: Tessellate Clouds in Navy and Vanilla with Kirei Ink (Pine)



Product shown: Tessellate Clouds in Navy and Vanilla with Kirei Ink (Pine)

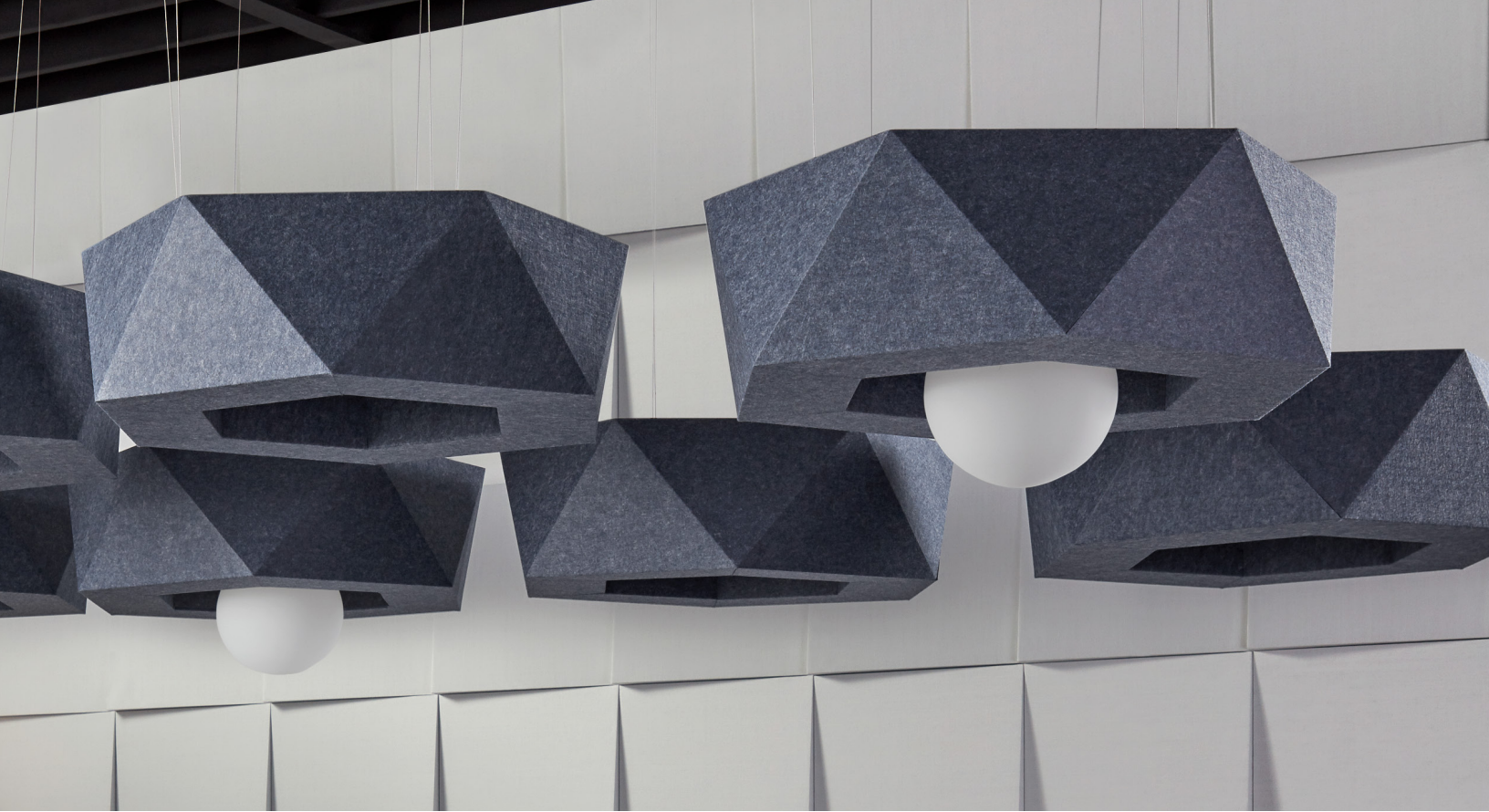

Product shown: Tessellate Clouds in Navy with added lighting

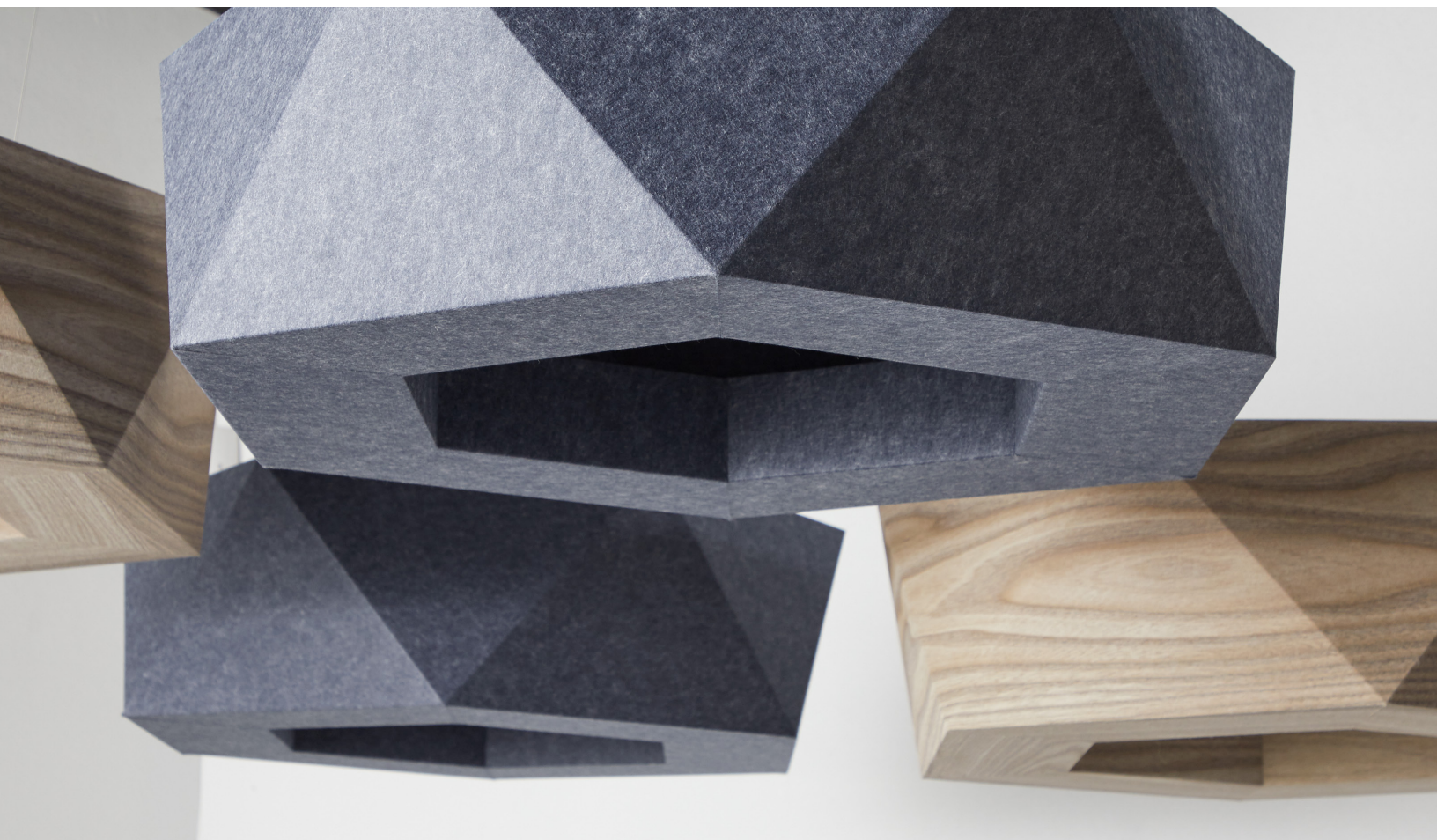

Product shown: Tessellate Clouds in Navy and Vanilla with Kirei Ink (Pine)



Product shown: Tessellate Clouds in Navy

kirei

Learn more and request your free sample:

619.236.9924 | sales@kireiusa.com

kireiusa.com