



# kirei

## HYPERFLY™ CLOUDS

### Acoustic Ceiling Solution

Put an iconic spin on sublime sound design. Add soft curves and sound absorption to any ceiling using the dynamic design of HyperFly™ Clouds. Available in over 35 through-colors with the option for Kirei Ink printing, these press-fit assembled acoustic clouds are lighting-ready and available in 2 sizes for you to dial up the drama and create show-stopping spaces for your clients.

Product shown: HyperFly Clouds (Small and Large) in Nutmeg

# Specs

Style	Standard (Diameter)	Height	Weight	SF/Unit
Small	35"	5"	7 lbs	6.68
Large	47.4"	7.2"	10 lbs	12.25

All specs refer to singular products and not multiples unless specified. Due to the nature of the material, cutting and fabrication process, minor dimensional variances may occur.

Designer	Kirei/Michael DiTullo
Material Thickness	12mm
Material	100% PET (60% post-consumer recycled content)
Fire Rating	ASTM E84 Class A
Custom Options	Available upon request
Lead Time	Please refer to <a href="http://kireiusa.com">kireiusa.com</a> for updated lead times.
VOC Emissions	CDPH (CA 01350) Compliant TVOC: <0.5 mg/m <sup>3</sup>



\*Actual lead times are determined when the project goes into production and can change based on production schedule and all quantities, color and thicknesses being in stock at time of order. See [Kirei's Product Lead Time Disclosure](#) for more information.



# Acoustic Data - HyperFly™ Cloud (Small)

## Sound Absorption

Frequency	125Hz	250Hz	500Hz	1000Hz	2000Hz	4000Hz	Array-NRC	Array-SAA
$\alpha$ array (Sabins/ft <sup>2</sup> ) (SA/m <sup>2</sup> )	-0.03	0.04	0.23	0.49	0.65	0.80	0.35	0.36

## Sabins per Array

Frequency	125Hz	250Hz	500Hz	1000Hz	2000Hz	4000Hz
Sabins	-0.82	1.31	7.01	15.01	19.86	24.33

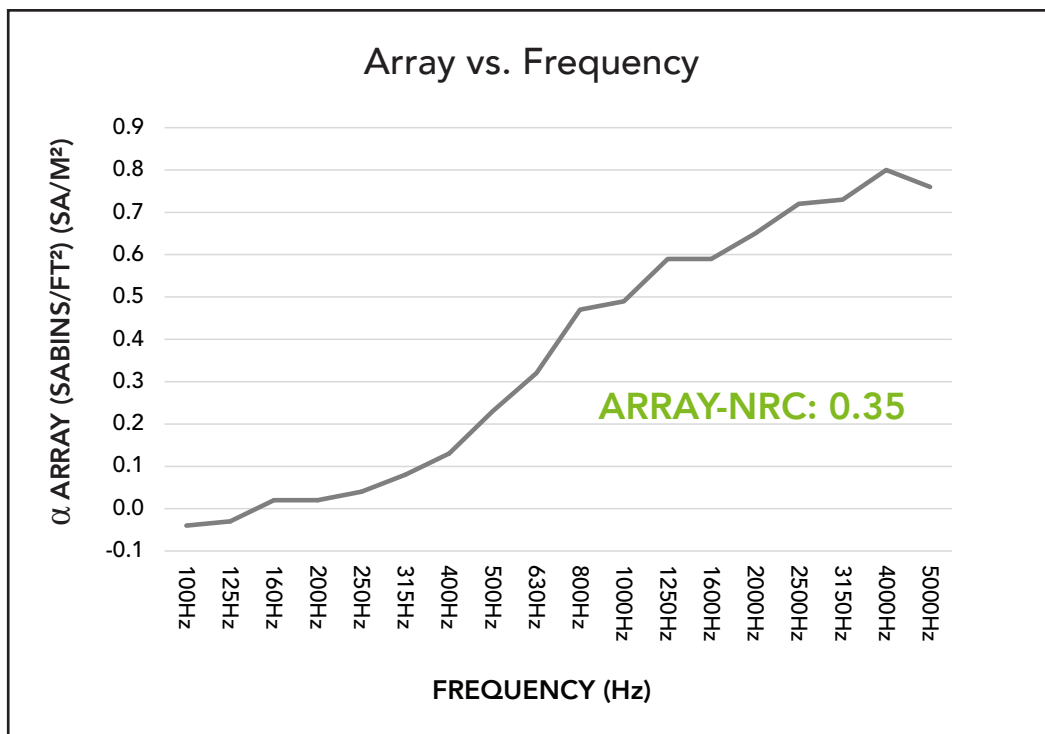

Acoustic data is measured in Array-NRC per HyperFly Cloud (Small) at 2 units spaced 12" apart. For more information, see the [full acoustic test](#).

# Acoustic Data - HyperFly™ Cloud (Large)

## Sound Absorption

Frequency	125Hz	250Hz	500Hz	1000Hz	2000Hz	4000Hz	Array-NRC	Array-SAA
$\alpha$ array (Sabins/ft <sup>2</sup> ) (SA/m <sup>2</sup> )	-0.04	0.04	0.355	0.55	0.72	0.81	0.40	0.42

## Sabins per Array

Frequency	125Hz	250Hz	500Hz	1000Hz	2000Hz	4000Hz
Sabins	-2.12	2.08	17.09	27.06	35.21	39.49

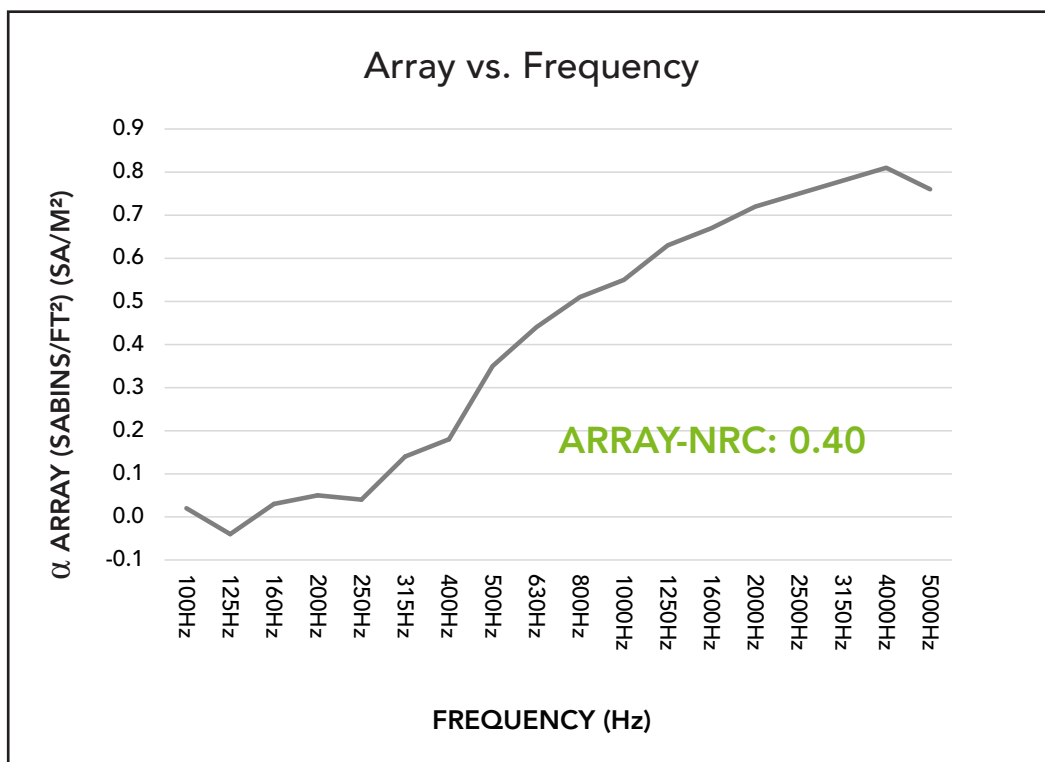

Acoustic data is measured in Array-NRC per HyperFly Cloud (Large) at 2 units spaced 12" apart. For more information, see the [full acoustic test](#).

# Product Dimensions

HyperFly™ Cloud (Small)

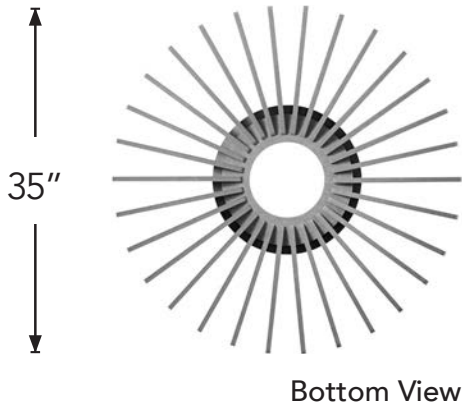

HyperFly Cloud™ (Large)

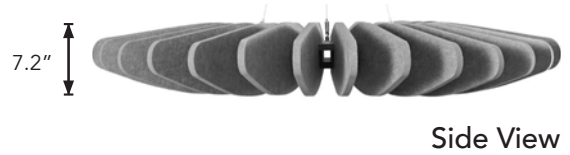
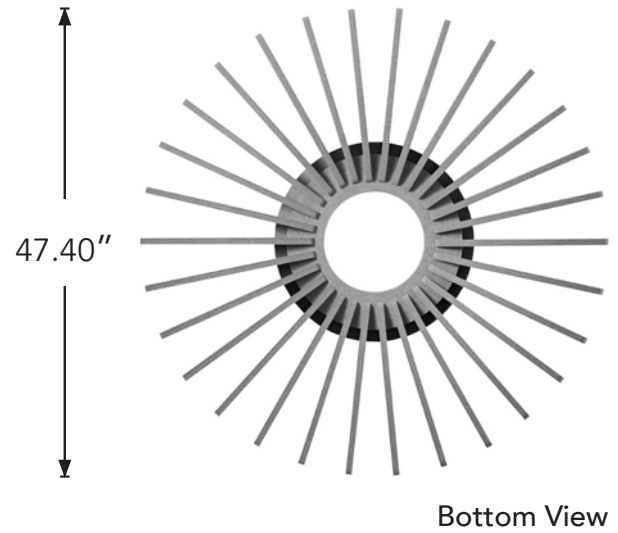

# Available Colors



**Cayenne 029**  
12mm



**Wine 009**  
12mm



**Rouge 007**  
12mm



**Crimson 059**  
12mm

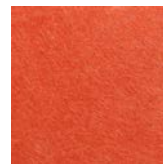

**Mandarin 013**  
12mm

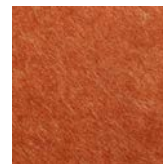

**Cinnamon 006**  
12mm



**Nutmeg 047**  
12mm



**Latte 055**  
12mm

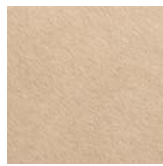

**Vanilla 028**  
12mm



**Dusk 032**  
12mm



**Blush 030**  
12mm



**Ochre 004**  
12mm

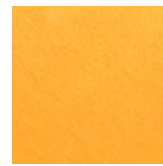

**Sunshine 003**  
12mm



**Butter 002**  
12mm



**Cappuccino 062**  
12mm



**Sepia 063**  
12mm



**Cream 048**  
12mm

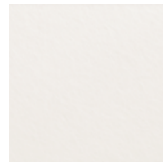

**White 033**  
12mm



**Mushroom 026**  
12mm



**Frost 001**  
12mm



**Grey 023**  
12mm

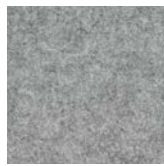

**Millennium 061**  
12mm



**Smoke 024**  
12mm



**Sage 042**  
12mm



**Pebble 022**  
12mm

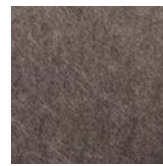

**Slate 025**  
12mm

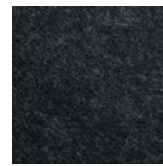

**Black 035**  
12mm



**Onyx 036**  
12mm



**Mint 038**  
12mm



**Duck Egg 037**  
12mm



**Pacific 045**  
12mm



**Lime Splice 020**  
12mm



**Pistachio 041**  
12mm



**Olive 021**  
12mm



**Jade 016**  
12mm

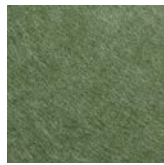

**Vineyard 017**  
12mm



**Seaweed 056**  
12mm



**Orchid 011**  
12mm



**Amethyst 060**  
12mm

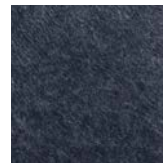

**Navy 019**  
12mm



**Coronet 046**  
12mm

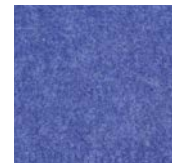

**Lapis 058**  
12mm

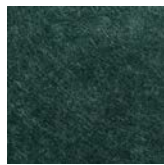

**Ivy 015**  
12mm

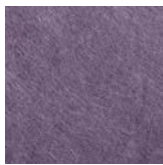

**Lavender 012**  
12mm

Color variation between dye lots is a natural characteristic of recycled PET felt due to the manufacturing process. Slight differences between samples and finished product may occur.

# Installation

HyperFly™ Clouds may be hung from a variety of ceiling types using cable suspension. HyperFly Cloud mounting options include three-point direct mount or three-way cloud kit. Select your mounting option for looks or flexibility as needed. Ceiling mounting hardware and cables are not included. These products are slot assembled on-site. For more information, see the [HyperFly Clouds Installation Guide](#).

*Note: Kirei does not provide ceiling mounting hardware or cable/chain/rod.*



HyperFly Cloud Hardware

# Custom Printing with Kirei Ink

HyperFly™ Clouds can be custom printed in house with Kirei Ink. Deliver endless customization possibilities from the natural beauty of botanicals to subtle or striking stonework. Pick from more than 50 prints over Kirei Ink's four collections or print your own custom color, pattern, graphic or material. We would love to work with you. Reach out and our team will be ready to assist!

Please note: Kirei requires written permission from the copyright holder in order to reproduce any copyrighted work. Professional photographs cannot be reproduced without written permission from the photographer. Keep in mind printing is not on the edges of the fully assembled product.



Product shown: HyperFly Cloud in Vanilla with Kirei Ink (Pine)



Product shown: HyperFly™ Clouds (Small & Large) in Vanilla with Kirei Ink (Pine)



Product shown: HyperFly™ Clouds (Small & Large) in Nutmeg

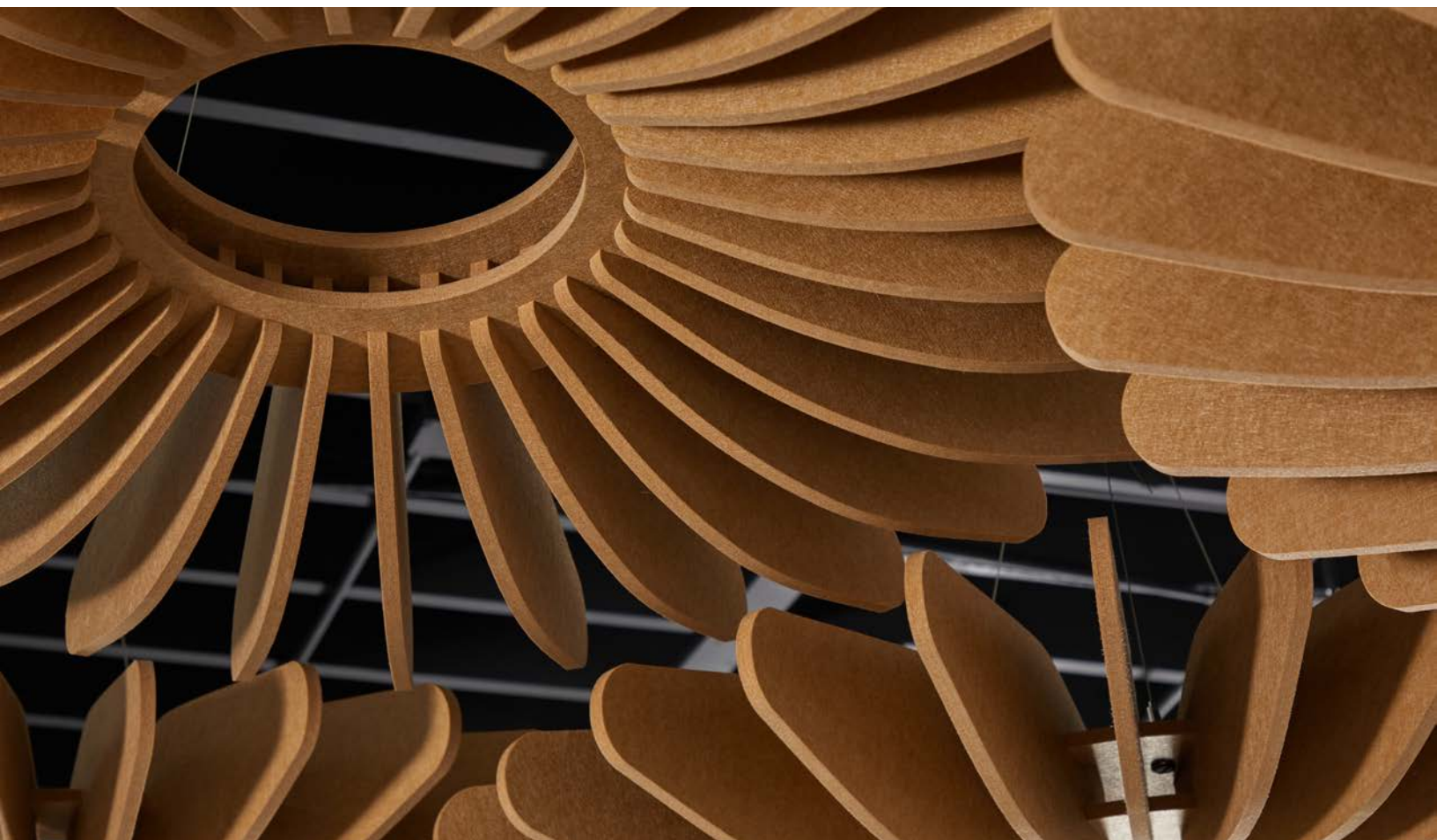

Product shown: HyperFly Clouds (Small & Large) in Nutmeg



Product shown: HyperFly™ Clouds (Small & Large) in Vanilla with Kirei Ink (Pine)

# kirei

Learn more and request your free sample:

619.236.9924 | [sales@kireiusa.com](mailto:sales@kireiusa.com)

[kireiusa.com](http://kireiusa.com)