



kirei

FOLD TILES

Acoustic Elements

Fold Tiles, one of Kirei's acoustically winning design features, offers visual motion and acoustic control. Cut-and-folded acoustic panels add depth to walls and ceilings while deflecting and absorbing sound. There are three standard sizes — Maxi, Mini, and Micro — and is available in a variety of colors from neutral to vibrant tones. Have a unique design idea? Customization is also available.

Product shown: Fold Tiles Micro in Coronet

Specs

Style	Standard (LxW)	Depth	Weight/Unit	SF/Unit
Maxi <i>1 peak p/unit</i>	46" x 14"	10.38"	5 lbs	4.5
Mini <i>1 peak p/unit</i>	46" x 8"	5.25"	2.5 lbs	2.6
Micro <i>1 peak p/unit</i>	46" x 6"	3" in.	1.4 lbs	1.7

All specs refer to singular products and not multiples unless specified. Due to the nature of the material, cutting and fabrication process, minor dimensional variances may occur. Custom options available upon request. Each Fold Tile style is sold as an individual unit with 1 peak, and does not have a backer. It ships flat, but is folded prior to installation for easy assembly.

Designer	Kirei
Material Thickness	12mm
Material	100% PET (60% post-consumer recycled content)
Fire Rating	ASTM E84 Class A
Custom Options	Available upon request
Lead Time	Please refer to kireiusa.com for updated lead times.
VOC Emissions	CDPH (CA 01350) Compliant TVOC: <0.5 mg/m3

*Actual lead times are determined when the project goes into production and can change based on production schedule and all quantities, color and thicknesses being in stock at time of order. See [Kirei's Product Lead Time Disclosure](#) for more information.



Acoustic Data

Sound Absorption

Frequency	250Hz	500Hz	800Hz	1000Hz	2000Hz	4000Hz	NRC
m ² /Object	3.78	6.72	7.27	6.72	8.00	8.15	0.95

Acoustic data is measured in Sabins per EchoFold Mini mounted on 0.5" fiberglass.

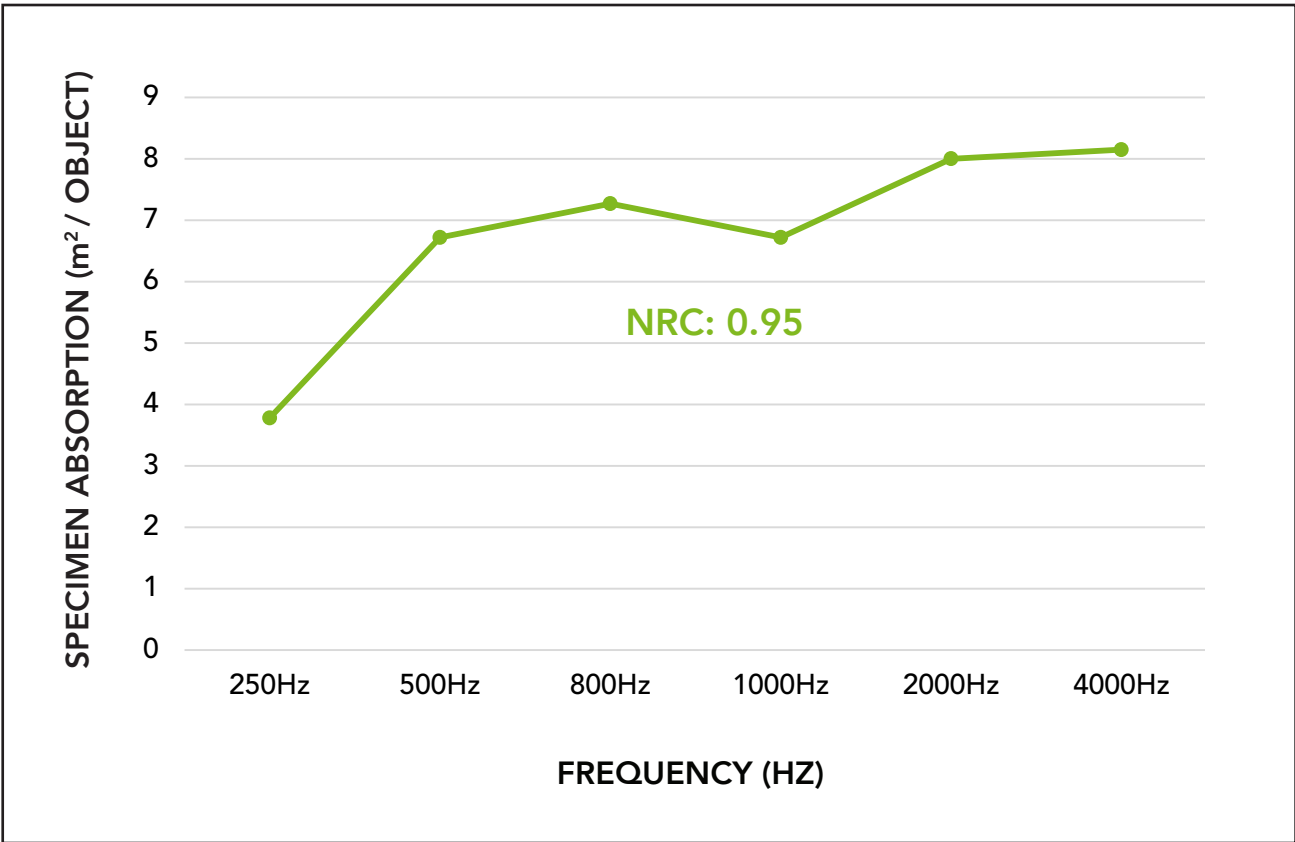

Product Dimensions

Maxi
2 peaks shown

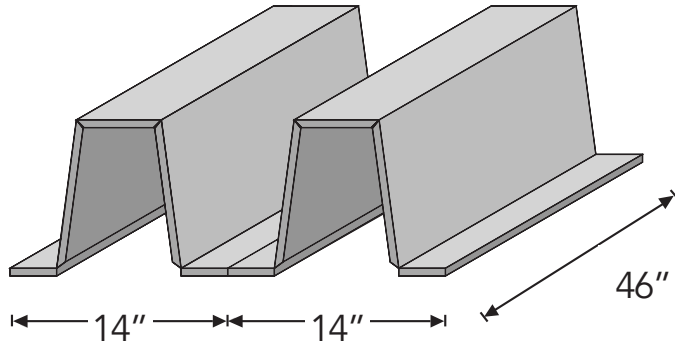

Maxi Peak

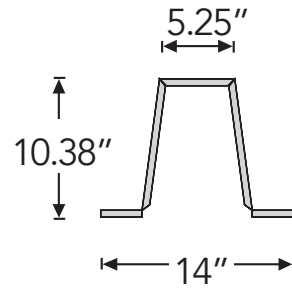

Mini
3 peaks shown

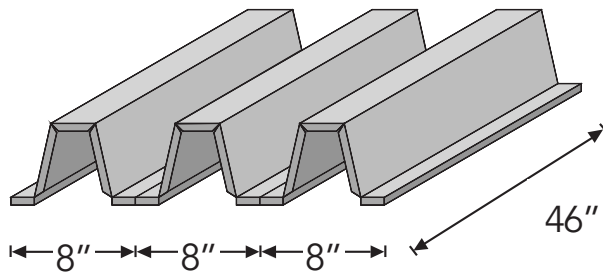

Mini Peak

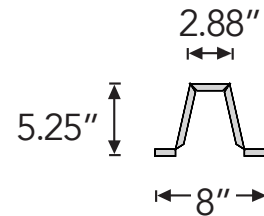

Micro
4 peaks shown

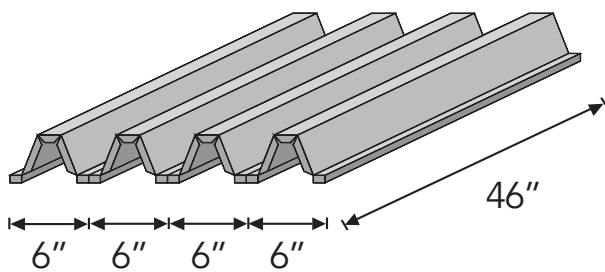

Micro Peak

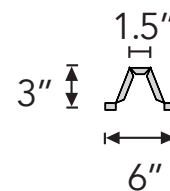

Available Colors



Color variation between dye lots is a natural characteristic of recycled PET felt due to the manufacturing process. Slight differences between samples and finished product may occur.

Installation

Fold Tiles ship flat, but are easily assembled by folding prior to installation. When mounting, use standard construction adhesives (e.g. Liquid Nails/Titebond - NOT PVA glue). Clean and prepare surface per adhesive guidelines. Spread adhesive evenly on panel back, leaving space at edges. Adhere to wall surface, providing bracing to hold material against surface per adhesive open time/instructions. For more information, see the [Fold Tiles Installation Guide](#).

Custom Printing with Kirei Ink

Fold Tiles can be custom printed in house with Kirei Ink. We would love to work with you to print your own custom color, pattern, graphic or material. Reach out and our team will be ready to assist!

Please note: Kirei requires written permission from the copyright holder in order to reproduce any copyrighted work. Professional photographs cannot be reproduced without written permission from the photographer.



Product shown: Fold Tiles Micro in Duck Egg with Kirei Ink (Horizontal Gradient)



Product shown: Fold Tiles Micro in Navy



Product shown: Fold Tiles Maxi in Smoke



Product shown: Fold Tiles Mini in Pebble

kirei

Learn more and request your free sample:

619.236.9924 | sales@kireiusa.com

kireiusa.com