

SIDEBAR ACT

INSTALLATION GUIDE

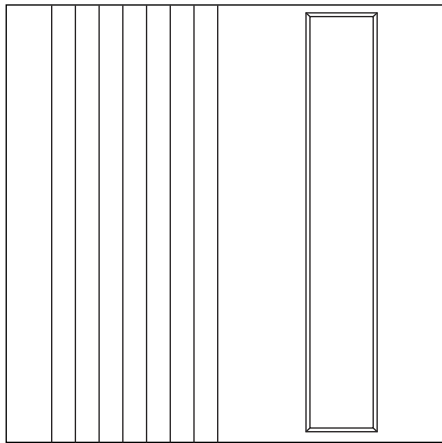

2x2

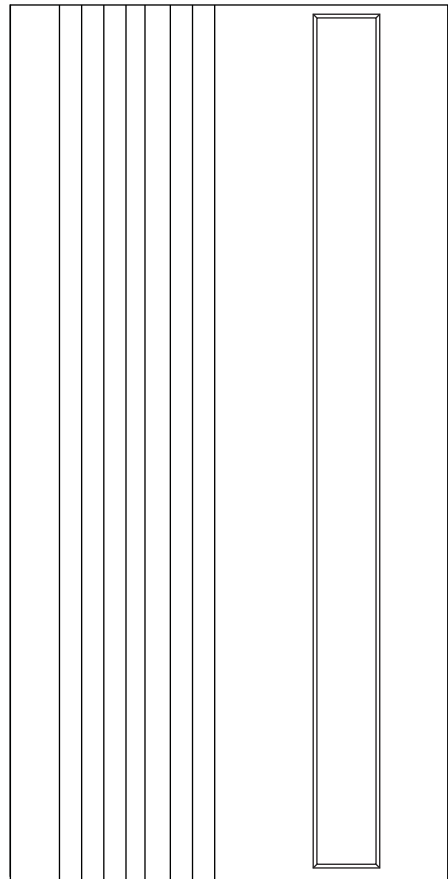

2x4

kirei

IMPORTANT INFORMATION

Installation

Please read the entire Installation Guide prior to application. This installation guide is intended to provide installers with helpful information regarding Sidebar ACT prior to installation. Kirei accepts no responsibility for installation actions taken or not taken. This installation guide is not intended to be an in-depth guide; installer's knowledge as an experienced tradesman needs to be applied.

This installation guide serves only as a recommendation for installing and handling Sidebar ACT. If you have questions about application or techniques, contact Kirei. Kirei will not be responsible for any cutting or mounting not performed by Kirei staff.

Terms of Trade

All Sidebar ACT tiles are inspected prior to shipment. Kirei is not responsible for damage in shipment or in storage; customers should carefully inspect all items at time of delivery and note any obvious damage on the delivery receipt. For the customer's protection, subsequently discovered concealed damage must be reported immediately to the carrier. Claims to Kirei will not be considered if the sheet has been worked on by the customer or others. No claims for labor charges will be allowed in any circumstances.

Work Safety

In the interest of work safety, it is recommended that people working with Sidebar ACT wear the appropriate safety equipment. Although the product emits zero off-gases, masks and gloves should be worn to ensure the maximum possible safety precautions. For an SDS form, please contact Kirei.

Cleaning

See the [Handling and Cleaning Guide](#) for more information.

Preparation

Carefully plan your installation to ensure you have sufficient tiles for the project. Plan, measure and mark your layout in advance to ensure accuracy of placement.

Sidebar ACT Specs

See the [Sidebar ACT Spec Sheet](#) for product details and information.

Product & Installation Questions

PH: 619.236.9924

Email: info@kireiusa.com

Web: kireiusa.com

HANDLING

Carry boxes and tiles upright.

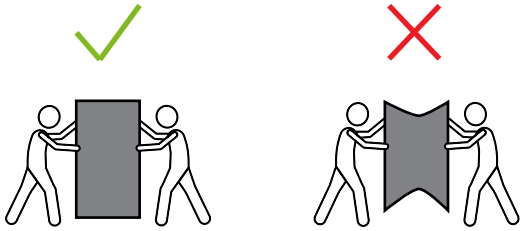

Keep all surfaces clean for storage and fabrication.

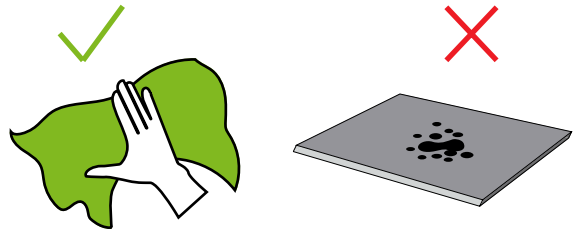

Store boxes and tiles flat.

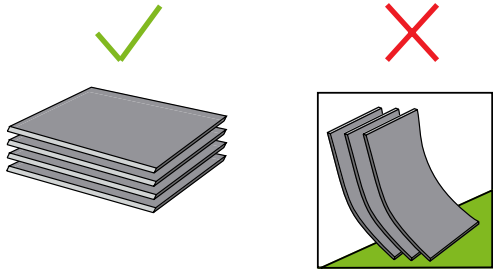

Store in a cool, dry place with no direct sun. Avoid 145 degree temperatures or greater.

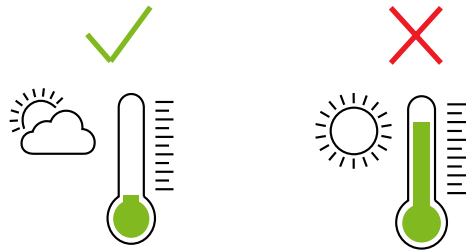

Wear gloves for handling light colors.

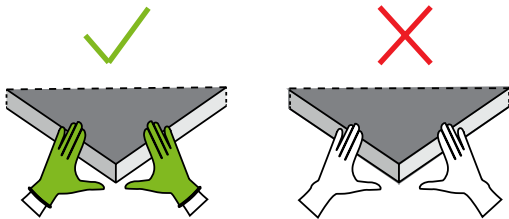

Upon delivery, inspect all goods for order corrections and damage.

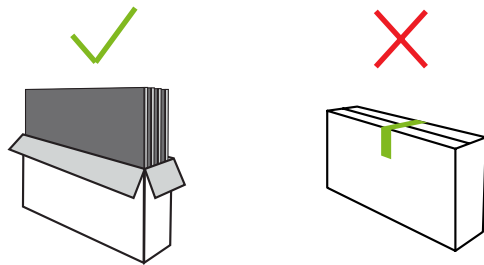

Keep product dry and avoid humidity.

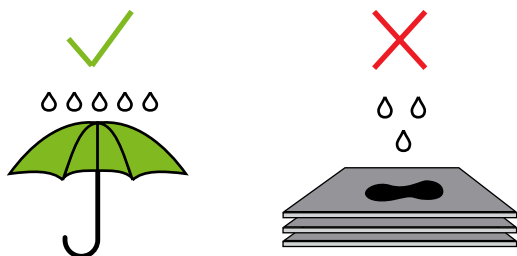

Protect the edges.

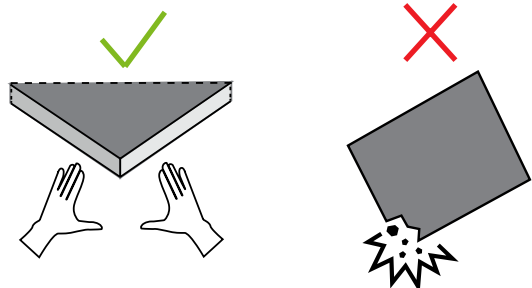

ITEMS INCLUDED

Sizes and styles selected when ordering per layout.

Sidebar ACT 2x2
(8 tiles per box)

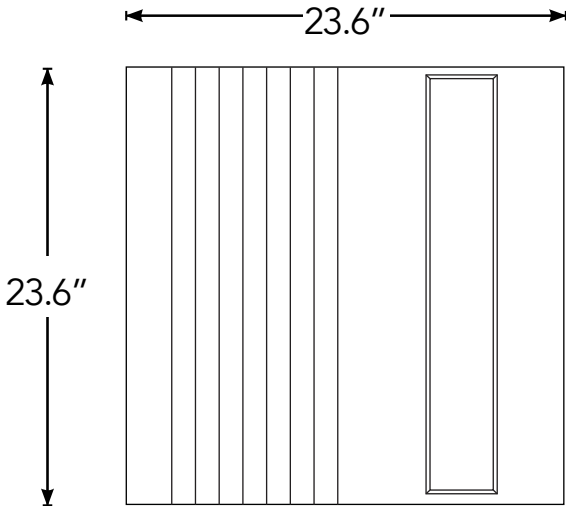

Sidebar ACT 2x4
(4 tiles per box)

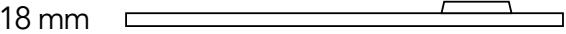
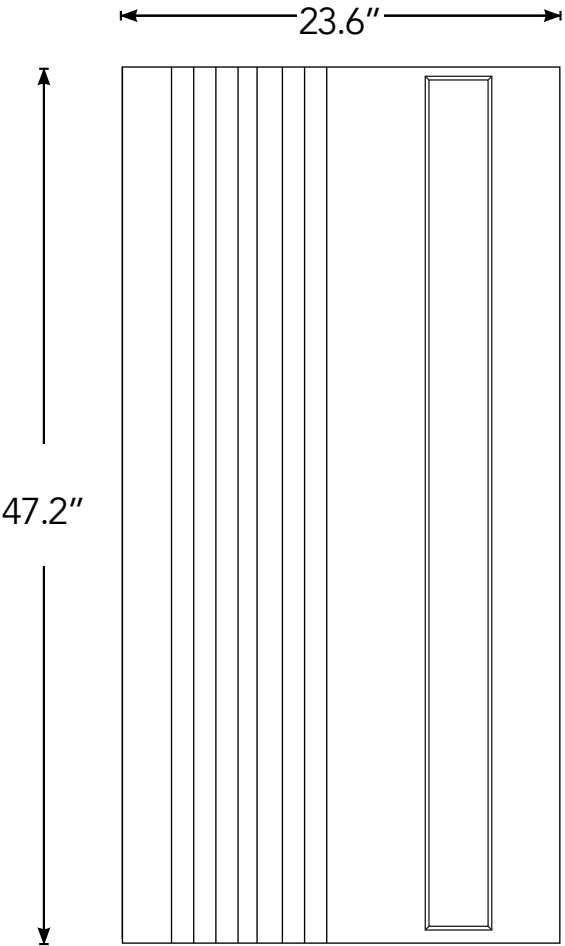

INSTALLATION

Sidebar ACT tiles work with a 15/16" grid and install just like regular ceiling grid tiles. Before getting started, make sure your platform or ladder is safe and secure before ascending. Ensure all surfaces and T-grid are clean prior to installation to prevent scuffs and staining, and make sure hands and/or gloves are clean before handling the material. Verify that you have 8"-10" unobstructed clearance above the T-Grid to ensure the Sidebar ACT tile can pass through the opening.

Note: Tiles have different design element directions. Refer to the architect's layout before installing prior to and during installation.

1. Hold Sidebar ACT flat side up in the correct orientation and so that the embellishment is facing down.
2. Angle the tile so that you can insert one end in first.
3. Insert the tile almost completely into the ceiling.
4. Carefully drop tile into place.
5. Visually inspect the design of the tile to ensure it lines up with adjacent tiles, adjusting the tile as needed.

kirei

CONTACT INFORMATION

Phone: 619.236.9924

Email: info@kireiusa.com

Web: kireiusa.com

Our Mission

Kirei strives to inspire a beautiful world by providing architects, interior designers, and placemakers with sustainable architectural design elements for inspiring healthy spaces.

Committed To Sustainability

Kirei prioritizes sustainable design in our materials and our process. Our products must contain a minimum of 50% or more recycled material, meet or exceed CDPH standards for VOCs, and must be Red List Free and Declare Label qualified/certified. From tiles made of plastic bottles to baffles filled with Nike Grind, being "green" is a key quality of all our products.

Our Proven Process

Our proven process is simple and guides all that we do. We listen and learn the needs of a designer's project to inspire and assist through the specification process. We get the spec right, working with installers and contractors to get accurate bid information. We provide best-in-class service that includes reliable delivery and installer support, ensuring that each project gets exactly what it needs when it needs it. Finally, we celebrate the designer, their project, and the win!