

PIZZELLE CLOUD

INSTALLATION GUIDE

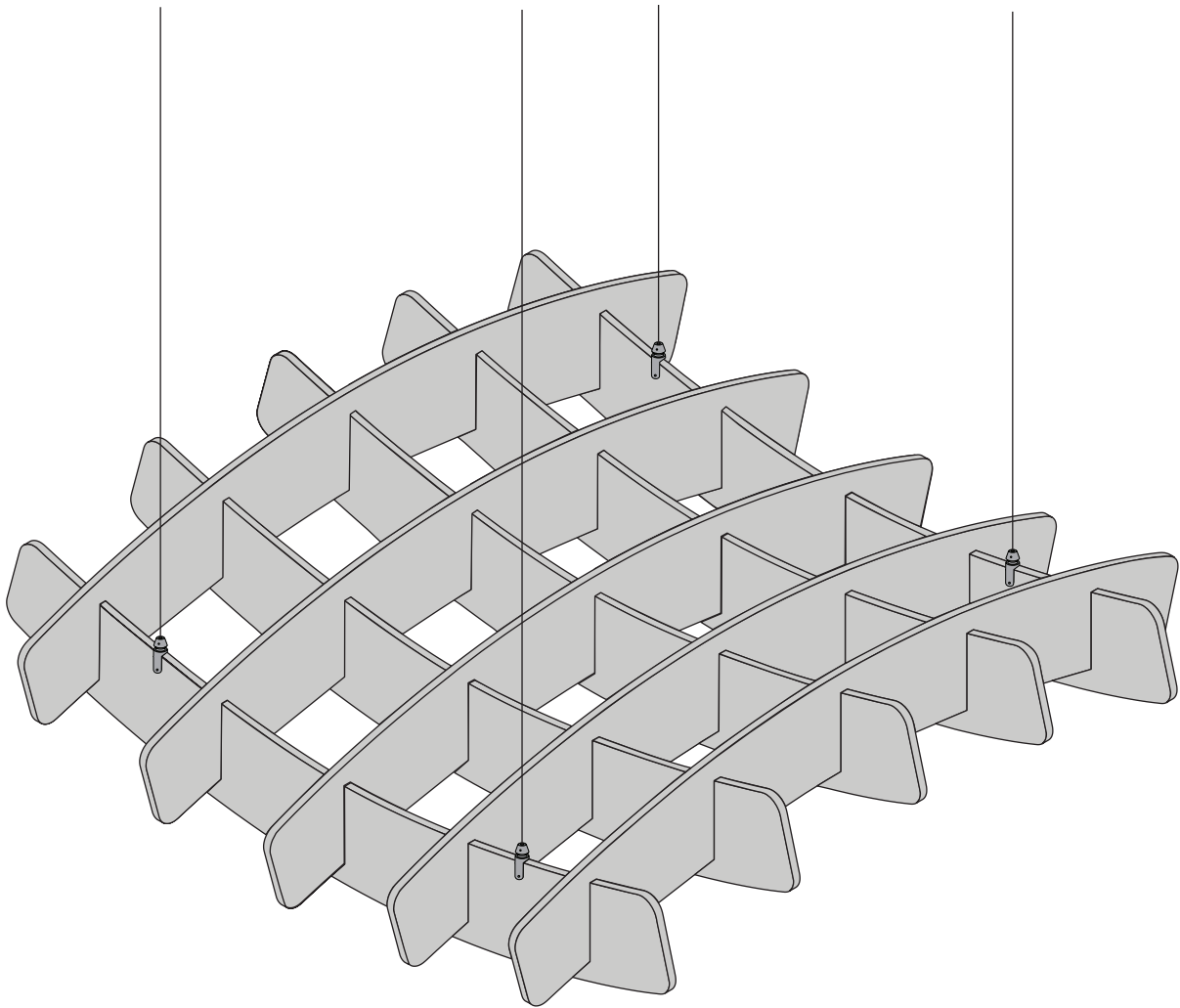

kirei

IMPORTANT INFORMATION

Installation

Please read the entire Installation Guide prior to application. This installation guide is intended to provide installers with helpful information regarding Pizzelle Cloud prior to installation. Kirei accepts no responsibility for installation actions taken or not taken. This installation guide is not intended to be an in-depth guide; installer's knowledge as an experienced tradesman needs to be applied.

If you have questions about application or techniques, contact Kirei. Kirei will not be responsible for any cutting or mounting not performed by Kirei staff.

Terms of Trade

All Pizzelle Cloud products are inspected prior to shipment. Kirei is not responsible for damage in shipment or in storage; customers should carefully inspect all items at time of delivery and note any obvious damage on the delivery receipt. For the customer's protection, subsequently discovered or concealed damage must be reported immediately to the carrier. Claims to Kirei will not be considered if the product has been worked on by the customer or others. No claims for labor charges will be allowed in any circumstances.

Work Safety

In the interest of work safety, it is recommended that people working with Pizzelle Cloud wear the appropriate safety equipment. Although the product emits zero off-gases, masks and gloves should be worn to ensure the maximum possible safety precautions. For an SDS form, please contact Kirei.

Product Notes

Pizzelle Cloud's acoustic performance will alter based on a variety of factors including spacing between Clouds.

Cleaning & Handling

Do not store Pizzelle Cloud vertically, please store laying flat.
See the [Handling and Cleaning Guide](#) for more information.

Pizzelle Cloud Specs

See the [Pizzelle Cloud Spec Sheet](#) for product details and information.

Product & Installation Questions

PH: 619.236.9924

Email: info@kireiusa.com

Web: kireiusa.com

HANDLING

Carry boxes and products upright.

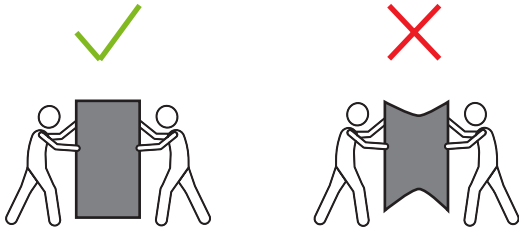

Keep all surfaces clean for storage and fabrication.

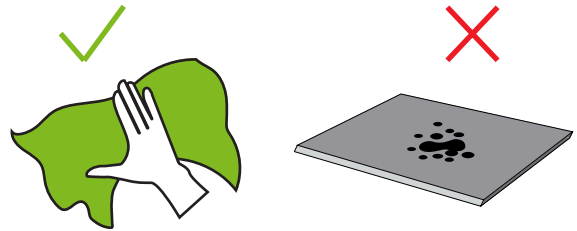

Store boxes and products flat.

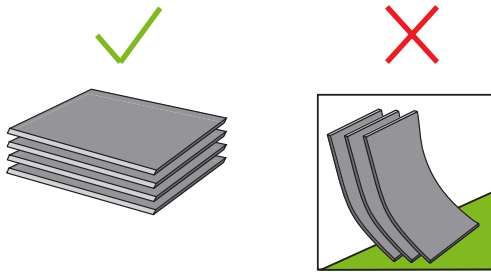

Store in a cool, dry place with no direct sun. Avoid 145 degree temperatures or greater.

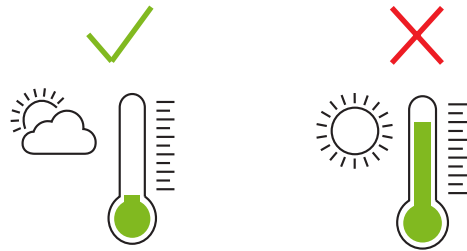

Wear gloves for handling light colors.

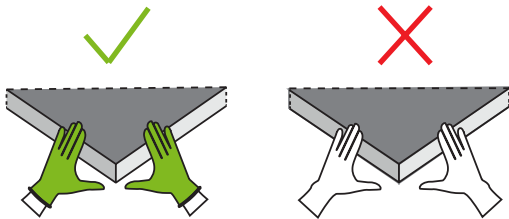

Upon delivery, inspect all goods for order corrections and damage.

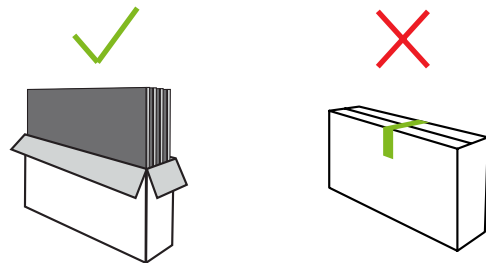

Keep product dry and avoid humidity.

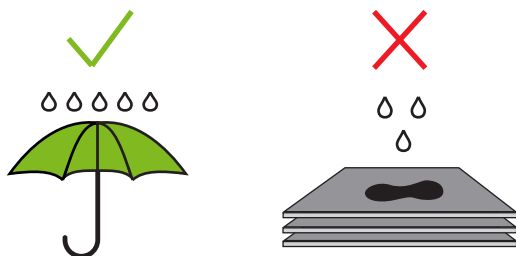

Protect the edges.

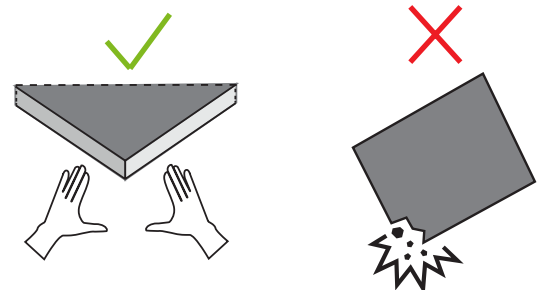

DIMENSIONS

Pizzelle Cloud

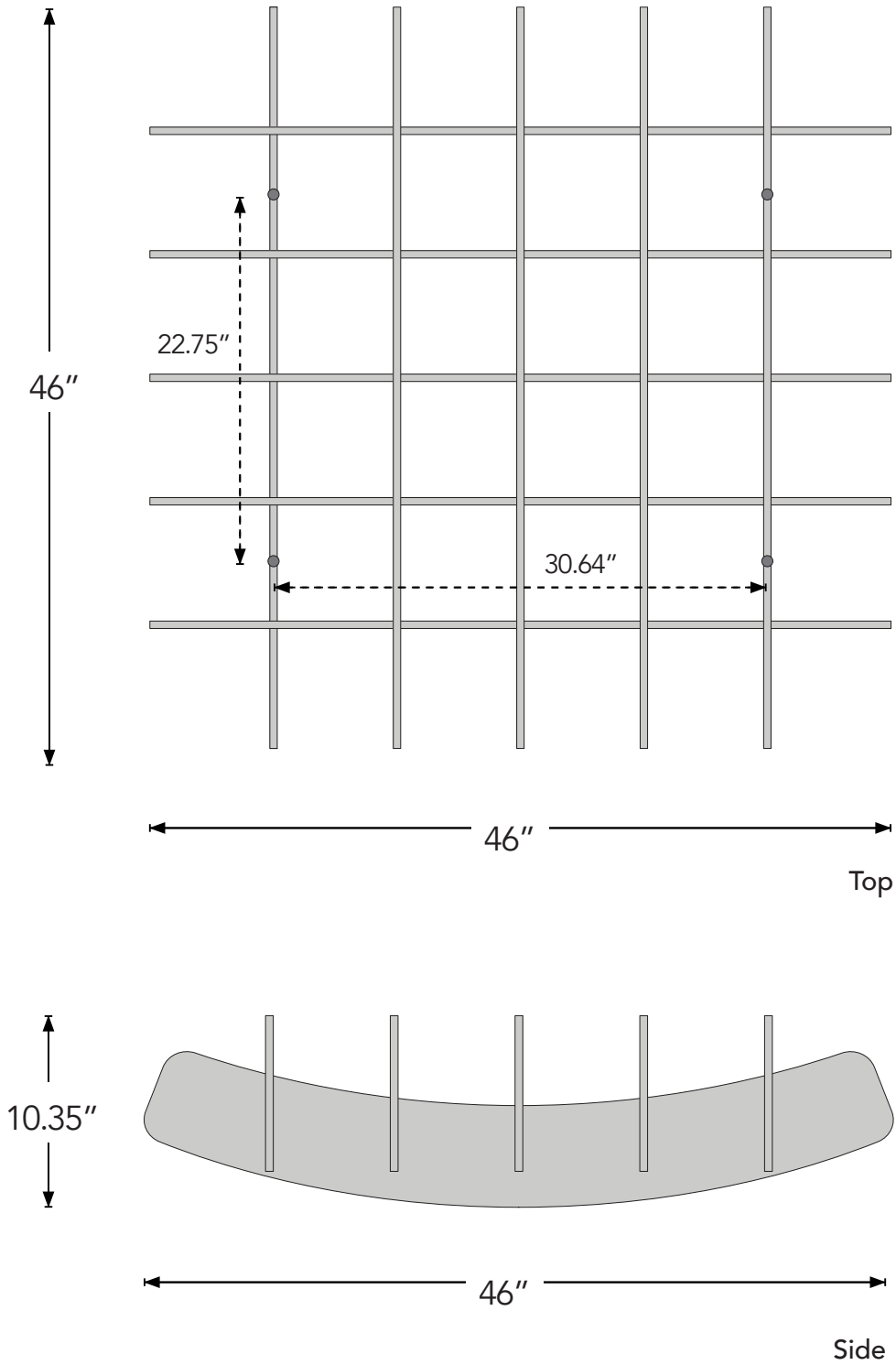

TOOLS THAT MAY BE NEEDED



Level

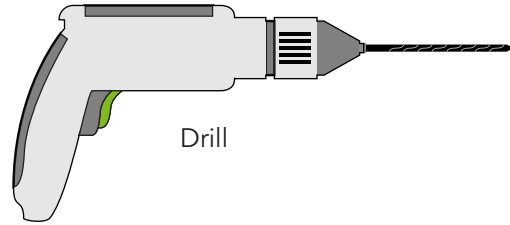

Drill

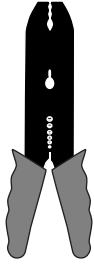

Crimper

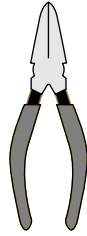

Wire Cutter

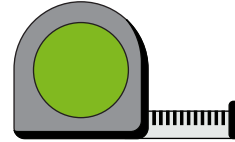

Tape Measure

Not all tools are needed for installation, but depending on install choice, could be used.

ITEMS INCLUDED

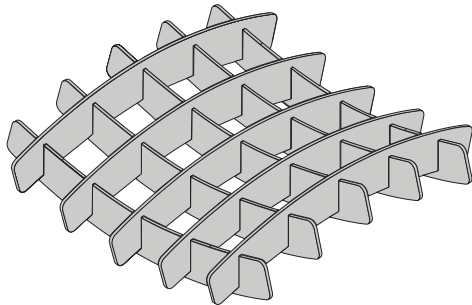

Pizzelle Cloud

- Per quantity ordered.
- Clouds are not assembled when shipped; assembly is required.



R2 Vertical Panel Grippers (1/2") with Screws

- (4) grippers per cloud

ITEMS NOT INCLUDED

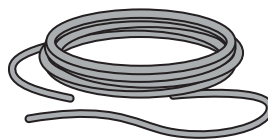

Compatible aircraft cables for the supplied cable grippers are 3/64" - 1/16"

Aircraft Cable

INSTALLATION

The safest and easiest install is achieved by evaluating the location in advance to determine and ensure that cable path from ceiling is unobstructed. Typically two people are needed for most install applications. Clouds are not assembled when shipped; assembly is required.

- 1 Remove cloud parts from the box. Confirm blades and hardware quantity, color, undamaged condition and compatibility of hanging hardware. Clean any debris off the unassembled cloud(s).

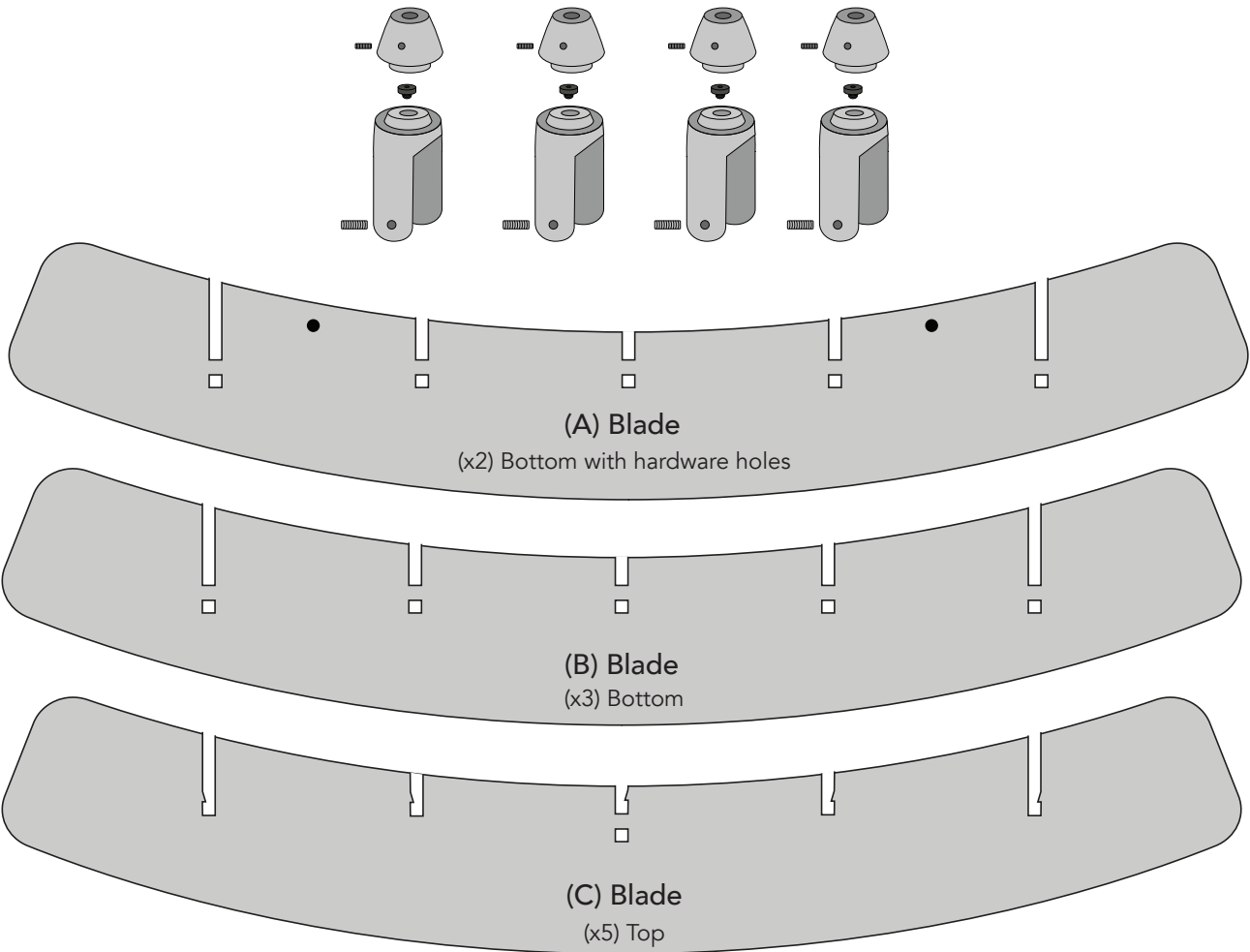

Blades & Hardware for (1) cloud

INSTALLATION

- 2** Assemble the supplied R2 Vertical Panel Gripper hardware. Then attach hardware to the pre-drilled holes on the two (A) blades. Each cloud has four attachment points - two points per blade on two (A) blades.

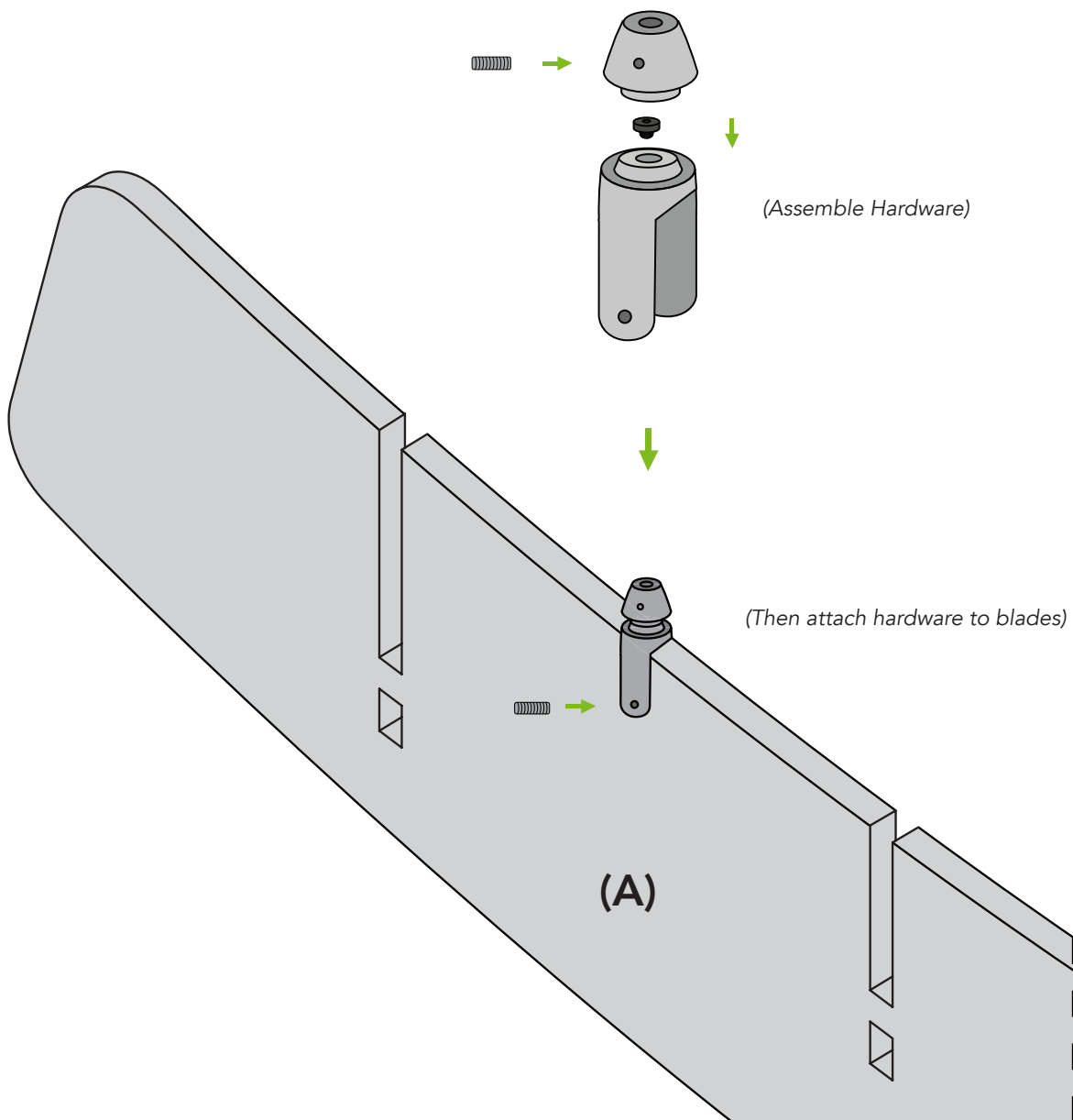

INSTALLATION

- 3 Once hardware is installed, lay out the five bottom blades about one foot apart. Put the three bottom blades with no hardware in between the two bottom blades with hardware, keeping them on the outside.

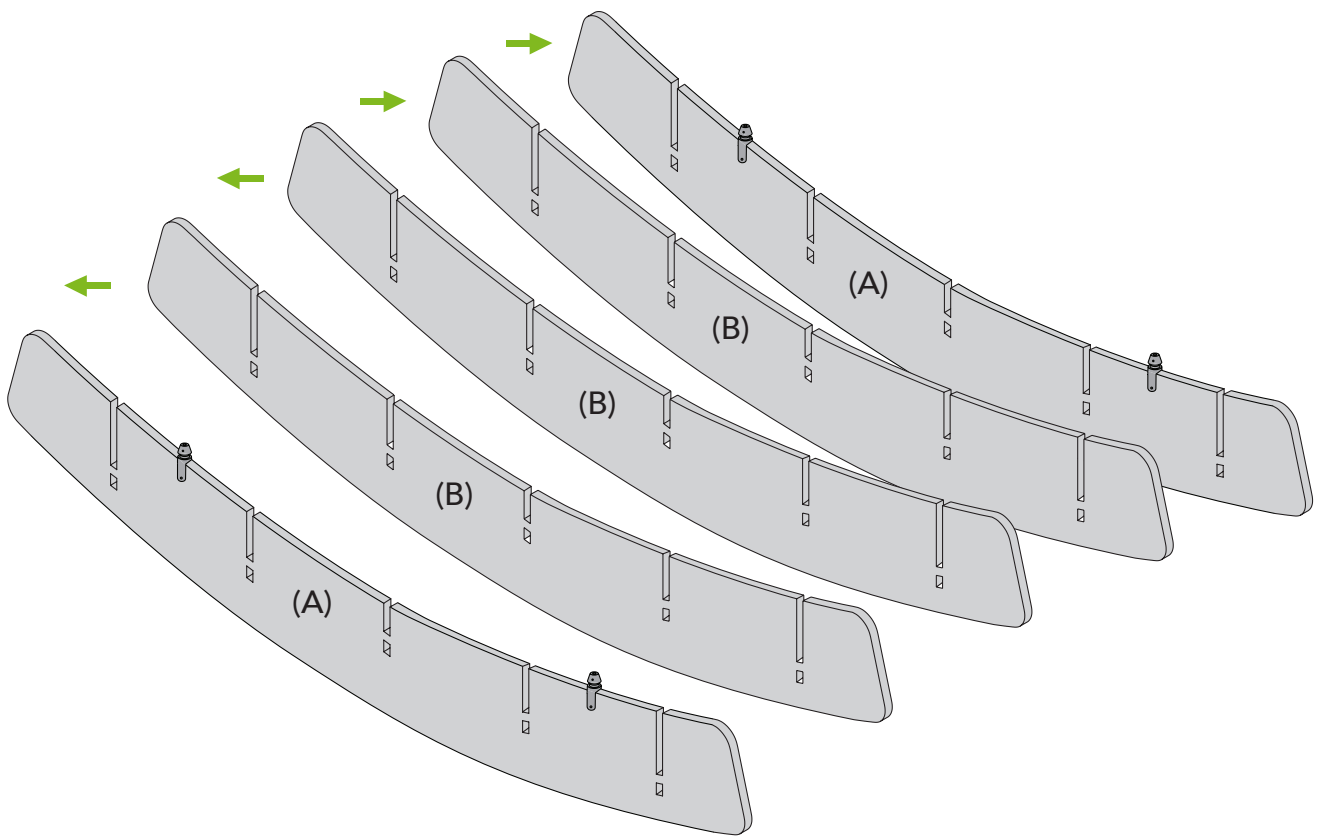

INSTALLATION

4

Once hardware is assembled, lay out the five bottom blades about one foot apart. Put the three (B) blades (with no hardware) inbetween the two (A) blades, keeping the (A) blades on the outside.

Then take a (C) blade and prepare to slot into the bottom blades. Line up the slits in the (C) blade with the slits in bottom blades and push until into place until you hear a click.

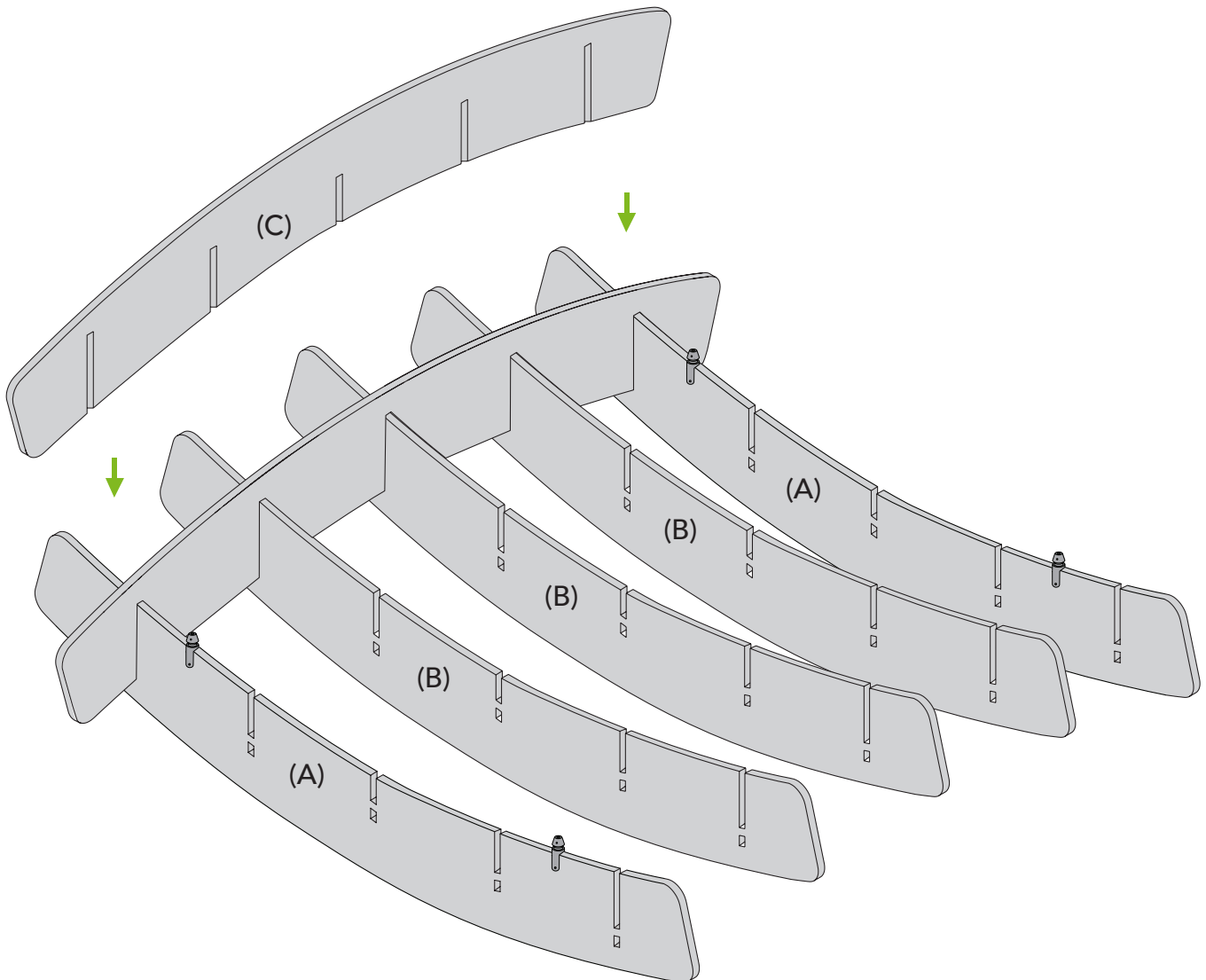

INSTALLATION

- 5 Repeat step 4 for the remaining four (C) blades until the cloud is assembled.

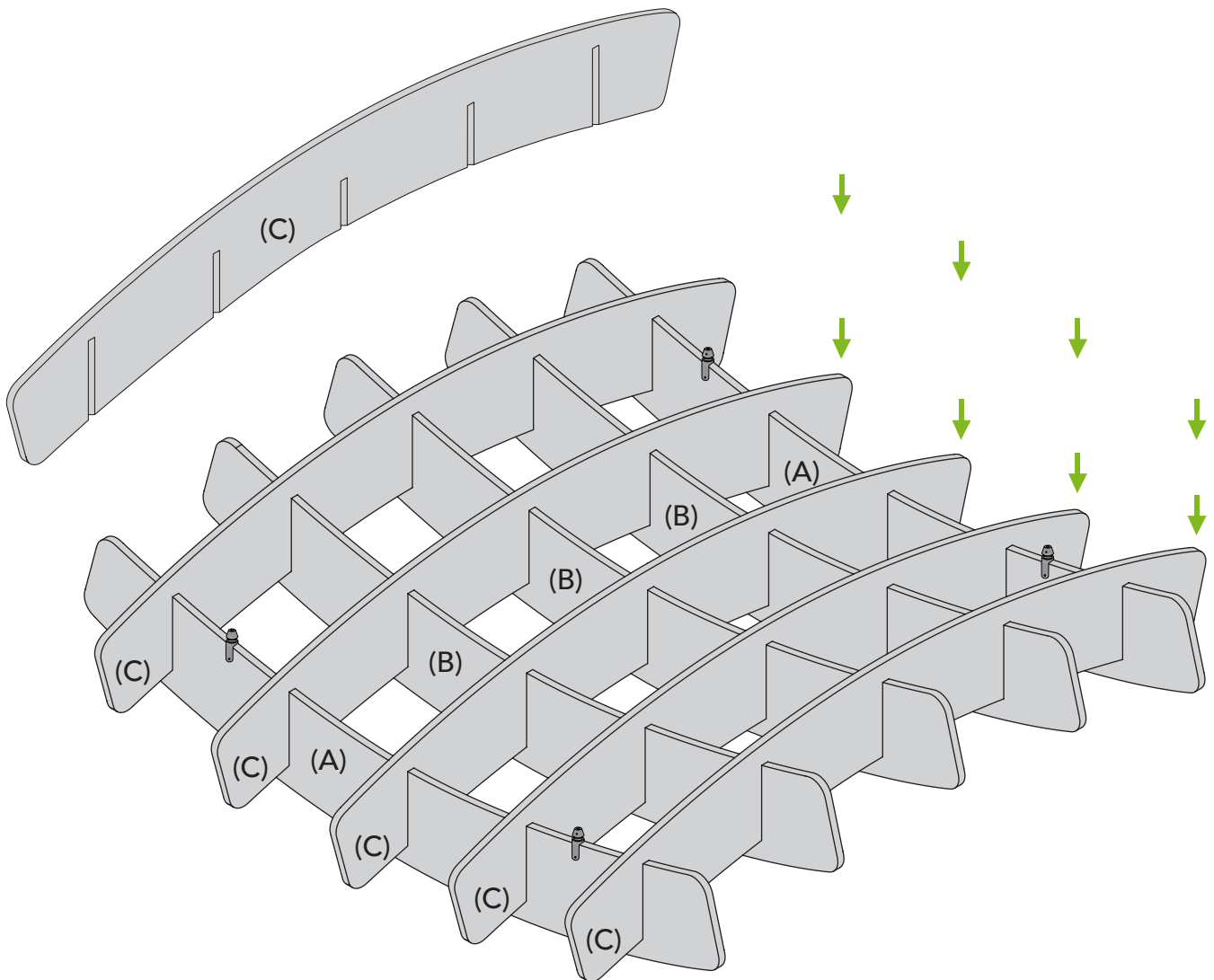

INSTALLATION

6

Assess the cloud design in relation to the hanging points and securely mount the appropriate hardware on ceiling. Attach cable to ceiling hardware and then attach other end of cable to the R2 Vertical Panel Grippers. Level cloud(s) by tightening the set screw when cable is at correct length. To ensure aircraft cable is tightly secured, pull on the attached aircraft cable with 15lbs of pressure.

Note: Ceiling mounting hardware and suspension items are not included.

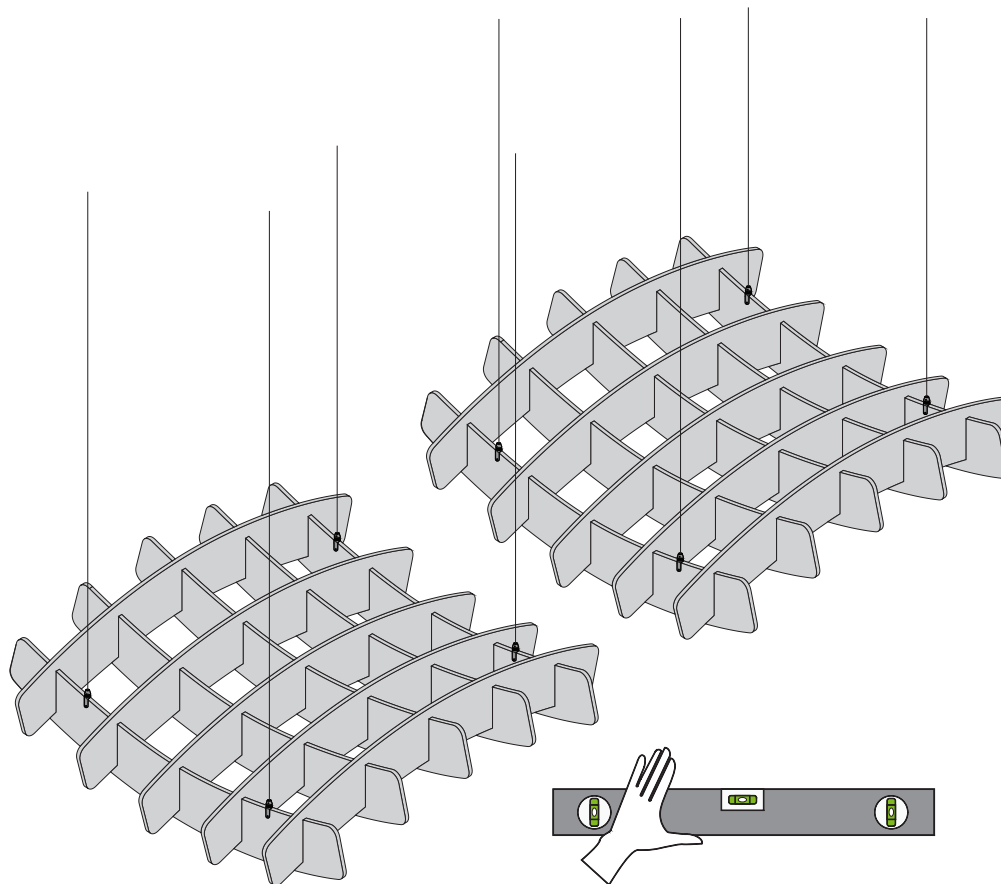

CONNECTORS

1

Connectors are provided upon request and are used to connect clouds. Five sets of connectors are given to connect two clouds. To connect clouds, locate the baffles of the clouds that have connector holes and line up these cloud ends next to each other. Next, place the first (X) piece on one side of the baffles and the second (X) piece on the other side (as seen below). Do this for all five baffle ends. Follow this process to connect multiple clouds.

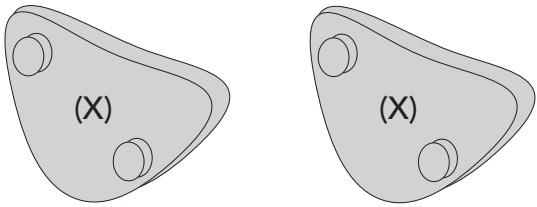

Cloud Connectors
5 sets to connect two clouds

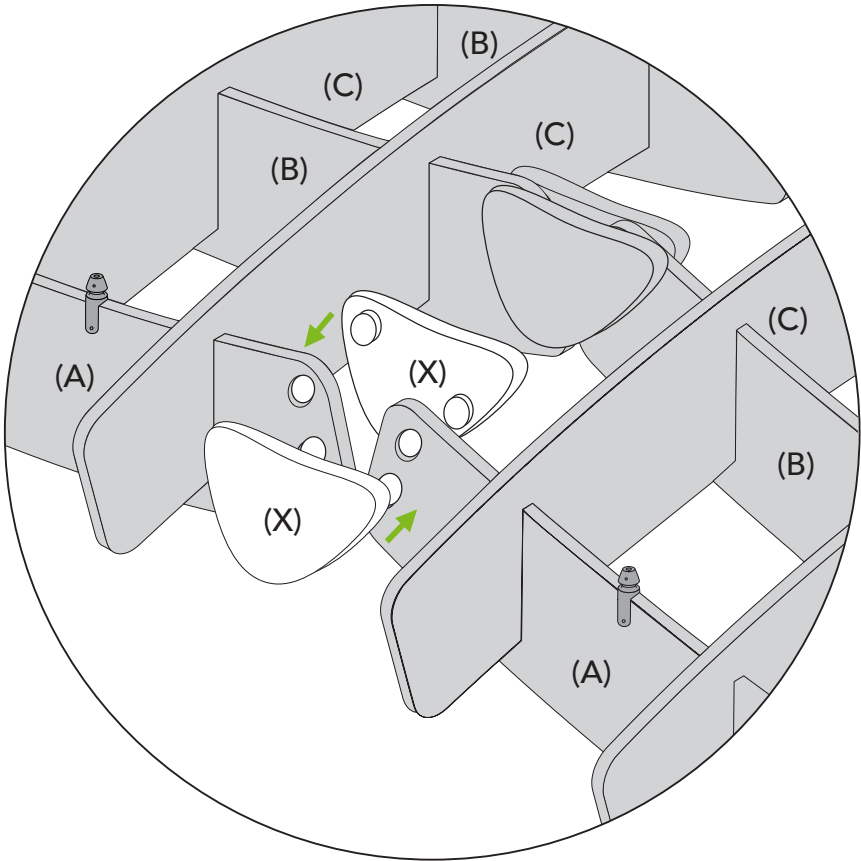

kirei

CONTACT INFORMATION

Phone: 619.236.9924

Email: info@kireiusa.com

Web: kireiusa.com

Our Mission

Kirei strives to inspire a beautiful world by providing architects, interior designers, and placemakers with sustainable architectural design elements for inspiring healthy spaces.

Committed To Sustainability

Kirei prioritizes sustainable design in our materials and our process. Our products must contain a minimum of 50% or more recycled material, meet or exceed CDPH standards for VOCs, and must be Red List Free and Declare Label qualified/certified. From tiles made of plastic bottles to baffles filled with Nike Grind, being "green" is a key quality of all our products.

Our Proven Process

Our proven process is simple and guides all that we do. We listen and learn the needs of a designer's project to inspire and assist through the specification process. We get the spec right, working with installers and contractors to get accurate bid information. We provide best-in-class service that includes reliable delivery and installer support, ensuring that each project gets exactly what it needs when it needs it. Finally, we celebrate the designer, their project, and the win!