

BREEZE CLOUD

INSTALLATION GUIDE

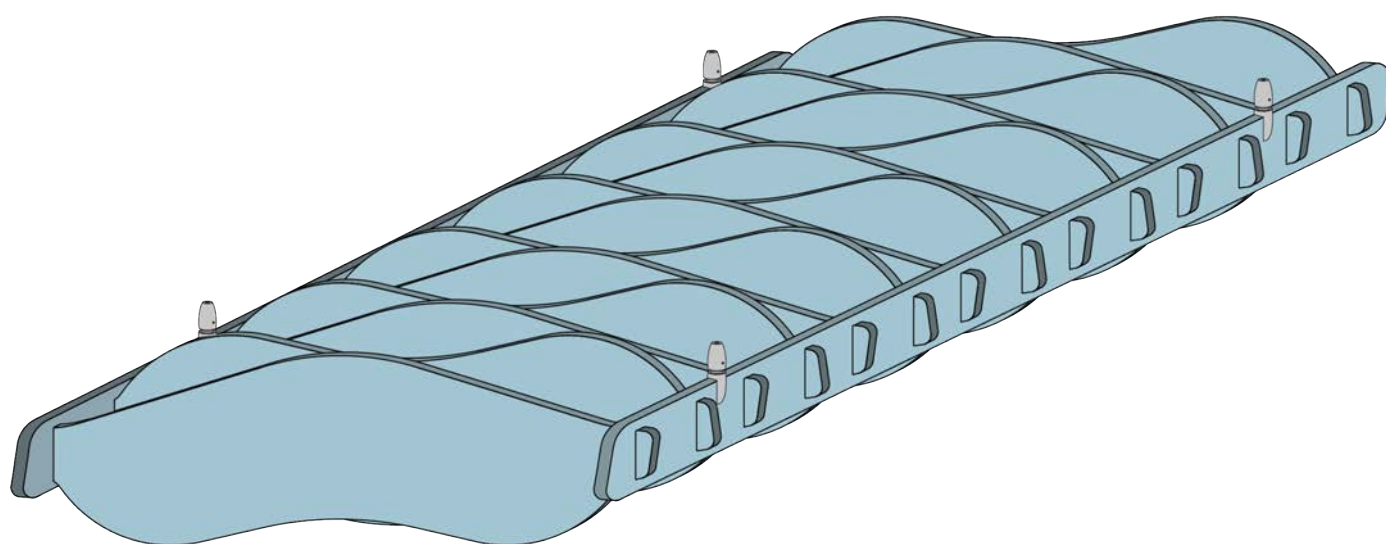

kirei

IMPORTANT INFORMATION

Installation

Please read the entire Installation Guide prior to application. This installation guide is intended to provide installers with helpful information regarding Breeze Clouds prior to installation. Kirei accepts no responsibility for installation actions taken or not taken. This installation guide is not intended to be an in-depth guide; installer's knowledge as an experienced tradesman needs to be applied.

If you have questions about application or techniques, contact Kirei. Kirei will not be responsible for any cutting or mounting not performed by Kirei staff.

Terms of Trade

All Breeze Cloud products are inspected prior to shipment. Kirei is not responsible for damage in shipment or in storage; customers should carefully inspect all items at time of delivery and note any obvious damage on the delivery receipt. For the customer's protection, subsequently discovered, concealed damage must be reported immediately to the carrier. Claims to Kirei will not be considered if the sheet has been worked on by the customer or others. No claims for labor charges will be allowed in any circumstances.

Work Safety

In the interest of work safety, it is recommended that people working with Breeze Clouds wear the appropriate safety equipment. Although the product emits zero off-gases, masks and gloves should be worn to ensure the maximum possible safety precautions. For an SDS form, please contact Kirei.

Product Notes

Breeze Cloud's acoustic performance will alter based on a variety of factors including spacing between clouds. Breeze Clouds have a grain that can reflect light differently, looking slightly lighter or darker depending on placement.

Cleaning & Handling

Do not store Breeze Clouds vertically, please store laying flat.
See the [Handling and Cleaning Guide](#) for more information.

Breeze Cloud Specs

See the [Breeze Cloud Spec Sheet](#) for product details and information.

Product & Installation Questions

PH: 619.236.9924

Email: info@kireiusa.com

Web: kireiusa.com

HANDLING

Carry boxes and products upright.

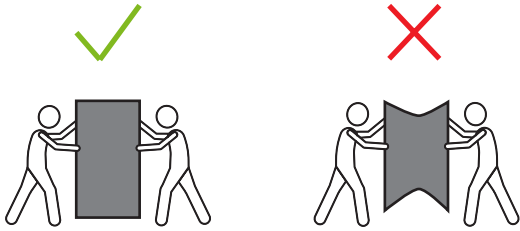

Keep all surfaces clean for storage and fabrication.

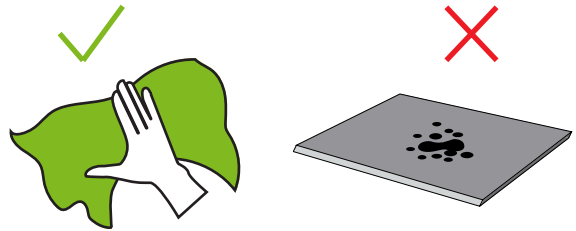

Store boxes and products flat.

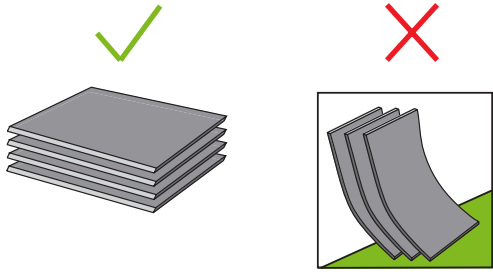

Store in a cool, dry place with no direct sun. Avoid 145 degree temperatures or greater.

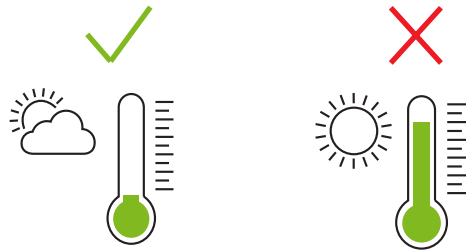

Wear gloves for handling light colors.

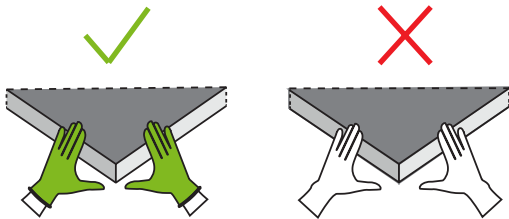

Upon delivery, inspect all goods for order corrections and damage.

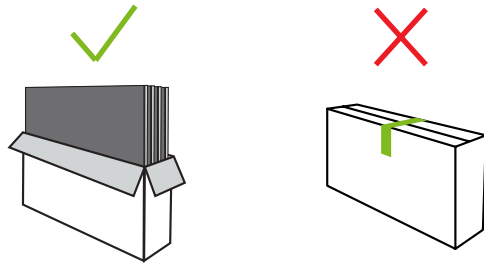

Keep product dry and avoid humidity.

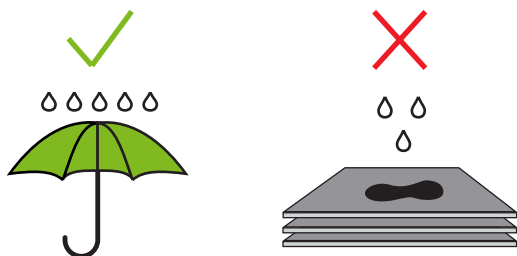

Protect the edges.

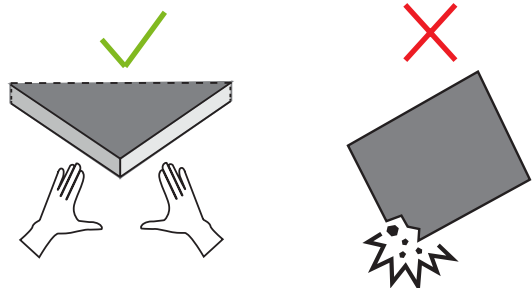

PRODUCT DIMENSIONS

Breeze Cloud

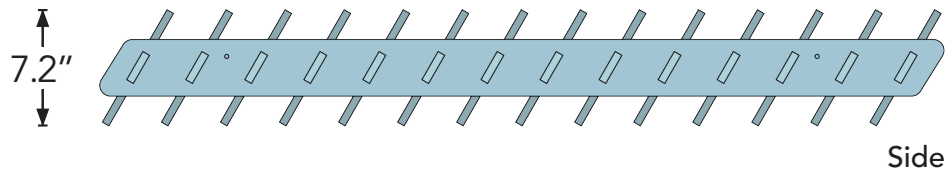
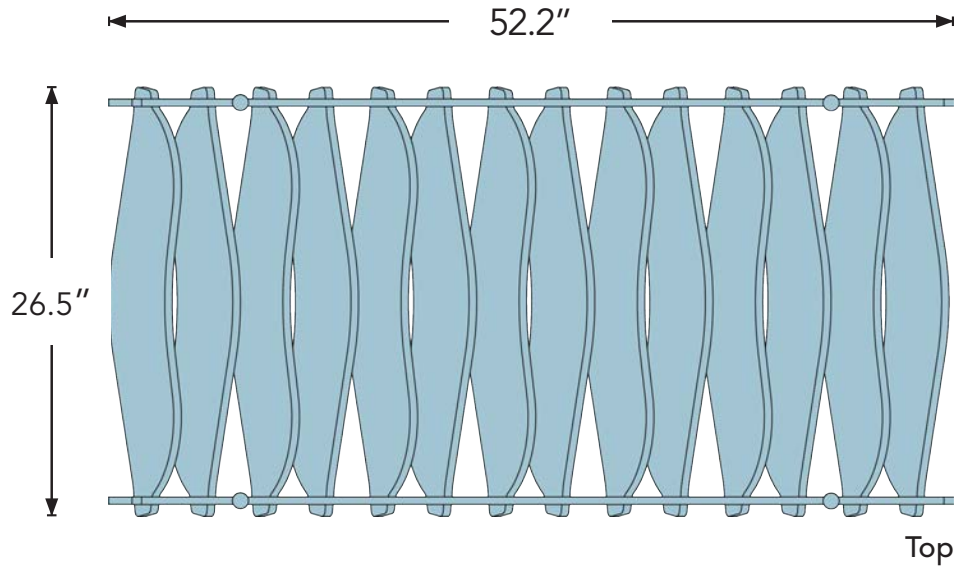

TOOLS THAT MAY BE NEEDED

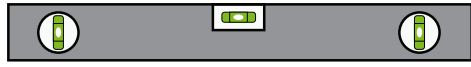

Level

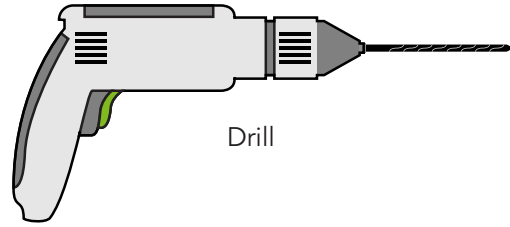

Drill



Crimper



Wire Cutter

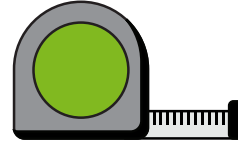

Tape Measure

Not all tools are needed for installation, but depending on install choice, could be used.

ITEMS INCLUDED

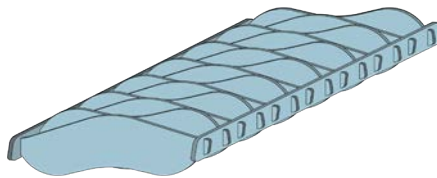

Breeze Cloud

*Per style and quantity ordered

*Clouds are not assembled when shipped; assembly is required

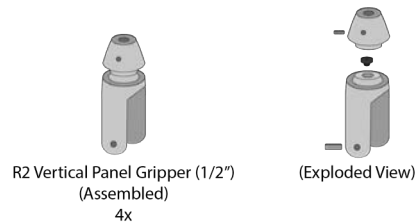

R2 Vertical Panel Gripper (1/2")
(Assembled)
4x

Hardware

*Per cloud

ITEMS NOT INCLUDED



Compatible aircraft cables for the supplied cable grippers are 3/64" - 1/16"

Aircraft Cable

INSTALLATION

The safest and easiest install is achieved by evaluating the location in advance to determine and ensure that cable path from ceiling is unobstructed. Typically two people are needed for most install applications. The clouds are not assembled when shipped; assembly is required.

- 1** Remove cloud parts from the box. Confirm part quantities, color, undamaged condition and compatibility of hanging hardware. Clean any debris off the unassembled cloud(s).

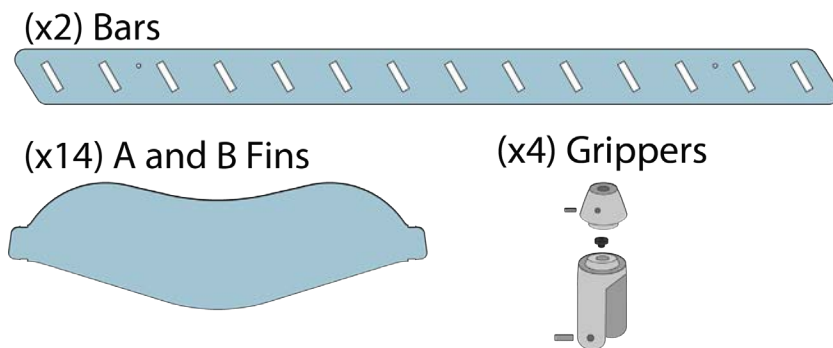

- 2** Assemble and attach hardware into the pre-drilled holes on the two 52.2" PET bars.

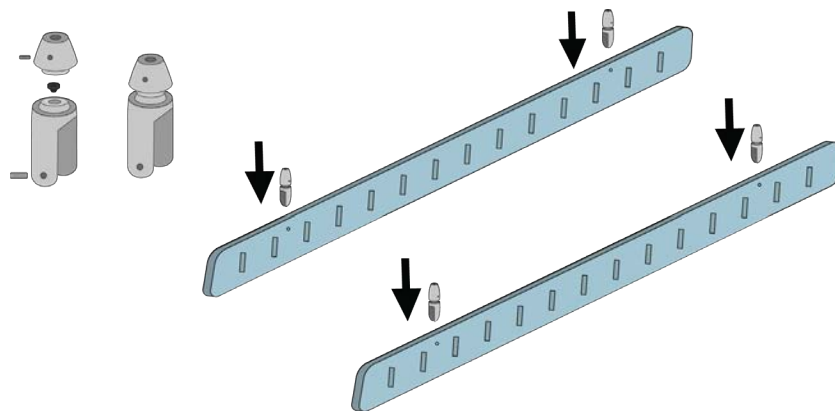

INSTALLATION

- 3** Slot the fins into one of the bars in an alternating pattern - starting with a double sloped fin facing downwards, with a single slope angled towards the center of the cloud (fin 'A' as indicated in drawing). Then continue to slot each fin in an alternating A and B pattern.

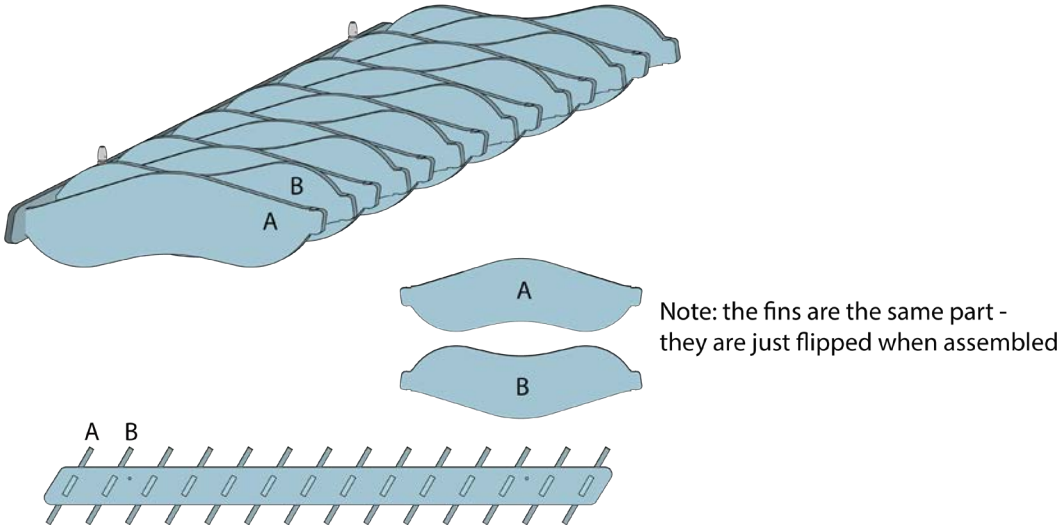

- 4** Line up the second bar and slot in the remaining side of the cloud.

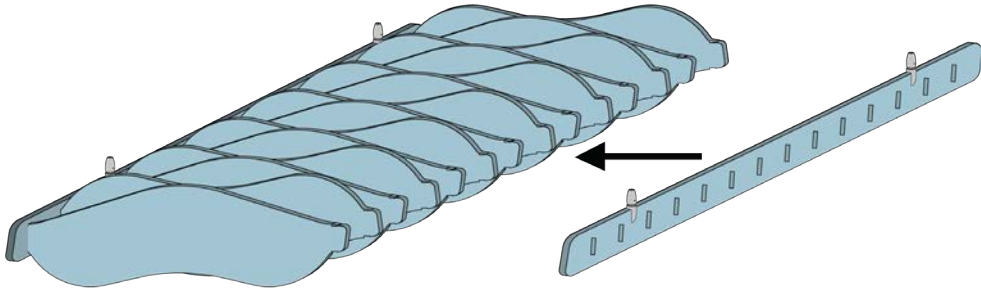

INSTALLATION

- 5 Once the ceiling hardware is installed, attach the cables to the supplied attachment hardware on the Breeze Cloud(s) and level the cloud(s).

Note: Ceiling mounting hardware and suspension items are not included.

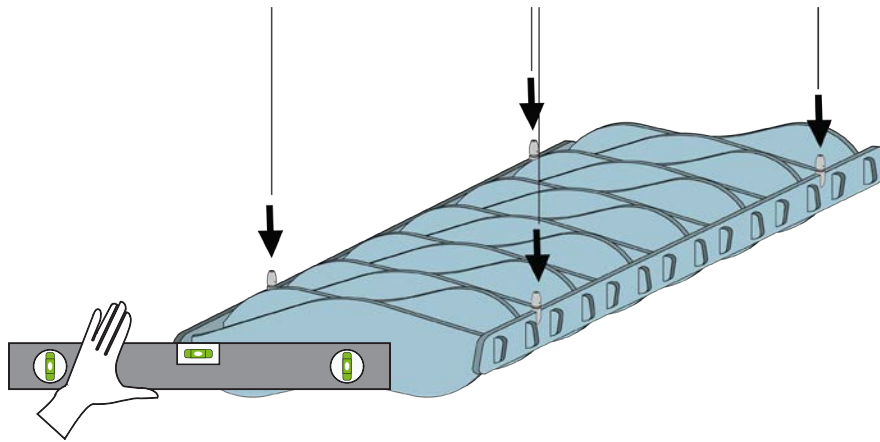

kirei

CONTACT INFORMATION

Phone: 619.236.9924

Email: info@kireiusa.com

Web: kireiusa.com

Our Mission

Kirei strives to inspire a beautiful world by providing architects, interior designers, and placemakers with sustainable architectural design elements for inspiring healthy spaces.

Committed To Sustainability

Kirei prioritizes sustainable design in our materials and our process. Our products must contain a minimum of 50% or more recycled material, meet or exceed CDPH standards for VOCs, and must be Red List Free and Declare Label qualified/certified. From tiles made of plastic bottles to clouds filled with Nike Grind, being "green" is a key quality of all our products.

Our Proven Process

Our proven process is simple and guides all that we do. We listen and learn the needs of a designer's project to inspire and assist through the specification process. We get the spec right, working with installers and contractors to get accurate bid information. We provide best-in-class service that includes reliable delivery and installer support, ensuring that each project gets exactly what it needs when it needs it. Finally, we celebrate the designer, their project, and the win!