

# STORM 80c

## Product Manual

English

# Table of Contents

Introduction .....	04
Components List.....	05
Product Overview.....	06
Setup.....	07
1.Attaching/Detaching the Protection Cover.....	07
2.Attaching/Detaching the Reflector.....	07
3.Attaching/Detaching the Mini Lantern Diffuser .....	07
4.Attaching/Detaching the Yoke.....	08
5.Setting Up the Lamp.....	09
6.Powering Up the 80c.....	09
7. Powering with External Battery.....	10
Operating Instructions.....	12
1. Powering On/Off .....	12
1.1 Status Indicator Icons .....	12
2. Manual Control.....	12
2.1 MENU.....	13
2.2 Light Modes .....	13
2.2.1 CCT .....	13
2.2.2 HSIC+ .....	13
2.2.3 RGB.....	14
2.2.4 GEL.....	14
2.2.5 Source.....	14
2.2.6 x y.....	15
2.2.7 FX .....	15
2.2.8 SidusFX .....	15
2.3 Control Settings.....	15
2.3.1 DMX Settings.....	16
2.3.2 CRMX Settings.....	17
2.3.3 Sidus BT Settings .....	20
2.3.4 Lead/Follow Mode .....	21

2.4 System Settings .....	21
2.4.1 Dimming Curve .....	22
2.4.2 Output Settings.....	22
2.4.3 White Light Standard.....	22
2.4.4 Fan Mode.....	23
2.4.5 Studio Mode .....	23
2.4.6 Screensaver.....	23
2.4.7 Language.....	24
2.4.8 Product Information.....	24
2.4.9 Firmware Update.....	26
2.4.10 Factory Reset.....	26
2.5 Presets.....	27
3.DMX Console Control.....	28
3.1 Connect the Lighting Console to the STORM 80c Control Box .....	28
3.2 Controlling via DMX.....	29
3.3 DMX Profile Setting .....	29
Product Specifications .....	30
Photometrics.....	31
Safety Instructions.....	33
FCC Compliance Statement .....	35
Disclaimer .....	36

# Introduction

Thank you for purchasing the Aputure® “STORM” series STORM 80c. The STORM 80c utilizes the BLAIR-CG light engine and is a point light source. The small but powerful 80c has an adjustable color temperature from 1800-20000K, and supports CCT, HSIC+, x y, RGB, GEL, SOURCE dimming modes. The STORM 80c is fully compatible with Sidus Link, Sidus Link Pro, DMX512/RDM, and LumenRadio CRMX control methods. The STORM 80c’s compact size and robust color engine provides a professional lighting solution and allows unprecedented creative freedom.

# Components List

Before using this product, please check that all of the following items are included in the package. If any are missing, please contact your dealer.

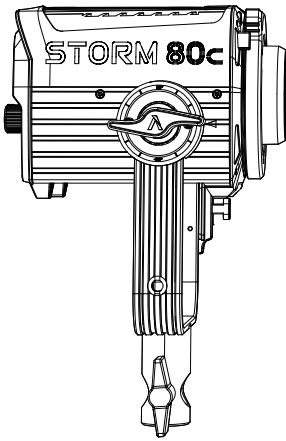

STORM 80c x1

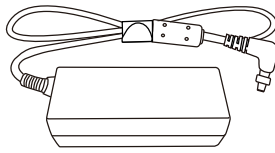

Power Supply x1



AC Power Cable x1

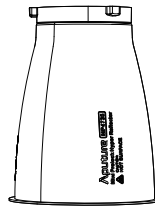

Hyper Reflector x1

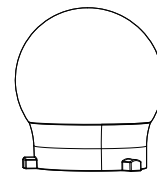

Mini Lantern Diffuser x1

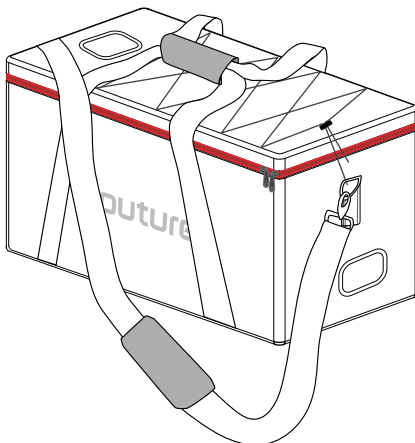

Carrying Soft Case x1



QR Code Card x1

*\* All illustrations in this manual are for reference only. Plug specifications vary per region. The physical product may also differ from the schematic diagram due to continuous updates and upgrades.*

# Product Overview

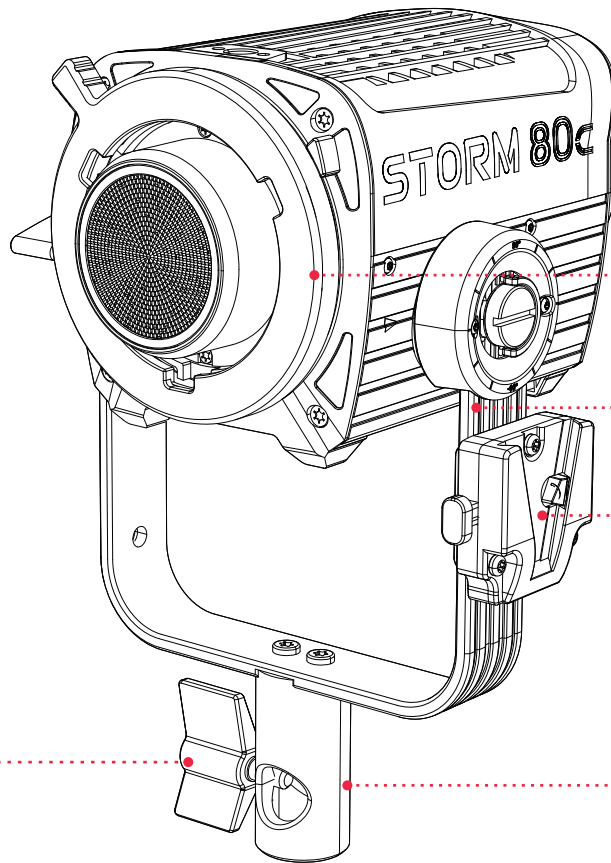

Aputure Mini Pro-Lock

Detachable Yoke

V-Mount Seat

Tie Down

5/8 in. Baby Receiver

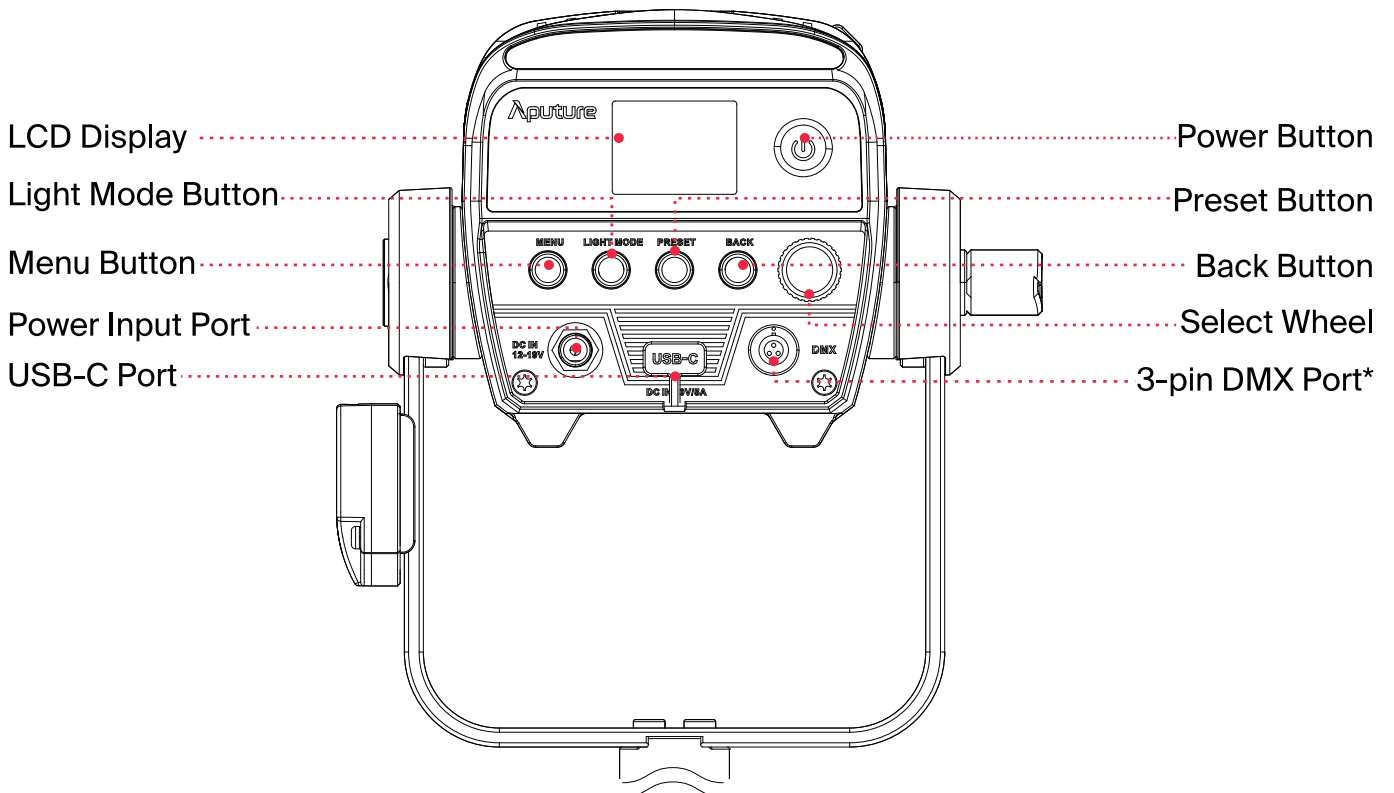

LCD Display

Light Mode Button

Menu Button

Power Input Port

USB-C Port

Power Button

Preset Button

Back Button

Select Wheel

3-pin DMX Port\*

\*Mini 3-Pin to 5-Pin XLR DMX IN/OUT adapter sold separately.

# Setup

## 1. Attaching/Detaching the Protection Cover

To detach the cover, rotate the Pro-Lock Handle to the open position and remove it.

To reattach the cover, insert it into place and rotate the Pro-Lock Handle clockwise until locked.

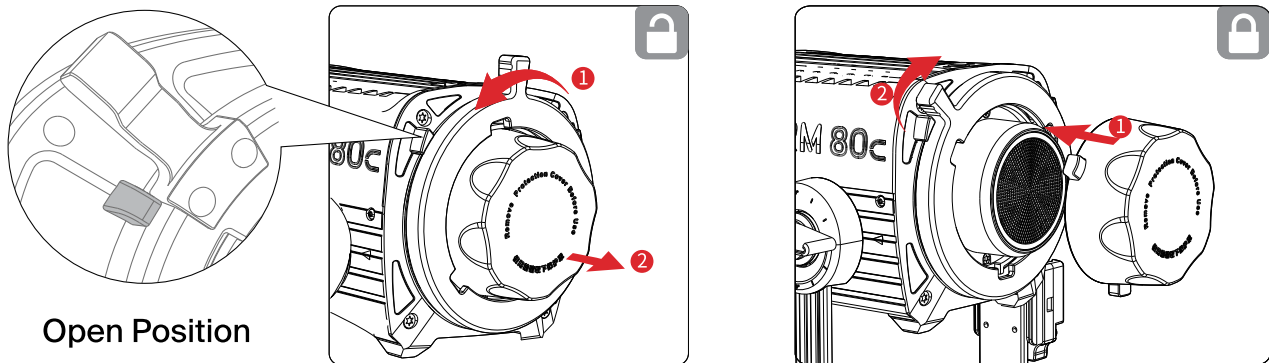

*\* Before use, please make sure to remove the protective cover. During transportation and storage, please attach the protective cover.*

## 2. Attaching/Detaching the Reflector

To attach the Reflector, insert it into the Mini Prolock Mount and rotate the Pro-Lock Handle clockwise until locked. To detach the Reflector, rotate the Pro-Lock Handle to the open position and remove it.

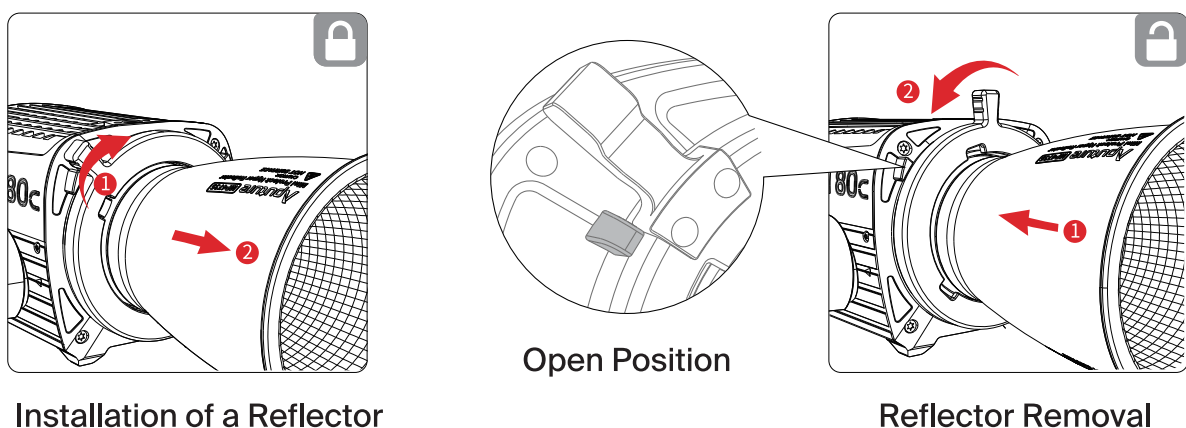

Installation of a Reflector

Reflector Removal

## 3. Attaching/Detaching the Mini Lantern Diffuser

To attach the Mini Lantern Diffuser, insert it into the Mini ProlockMount and rotate the Pro-Lock Handle clockwise until locked. To detach the Mini Lantern Diffuser, rotate the Pro-Lock Handle to the open position and remove it.

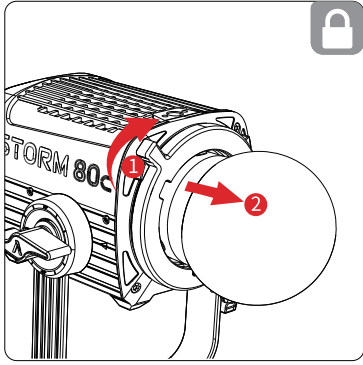

Installation of Diffuser

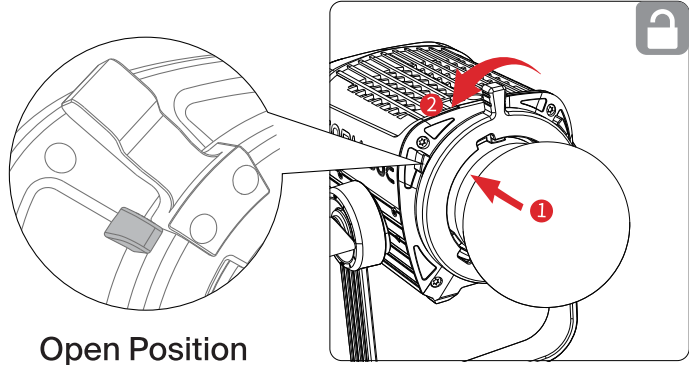

Open Position

Diffuser Removal

## 4. Attaching/Detaching the Yoke

Loosen or tighten the Locking handle and tie down for attaching/detaching the Yoke.

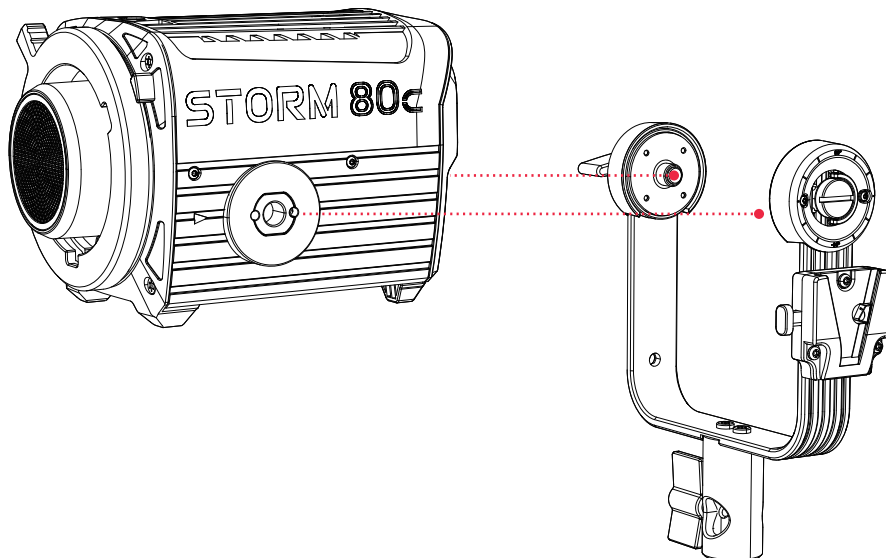
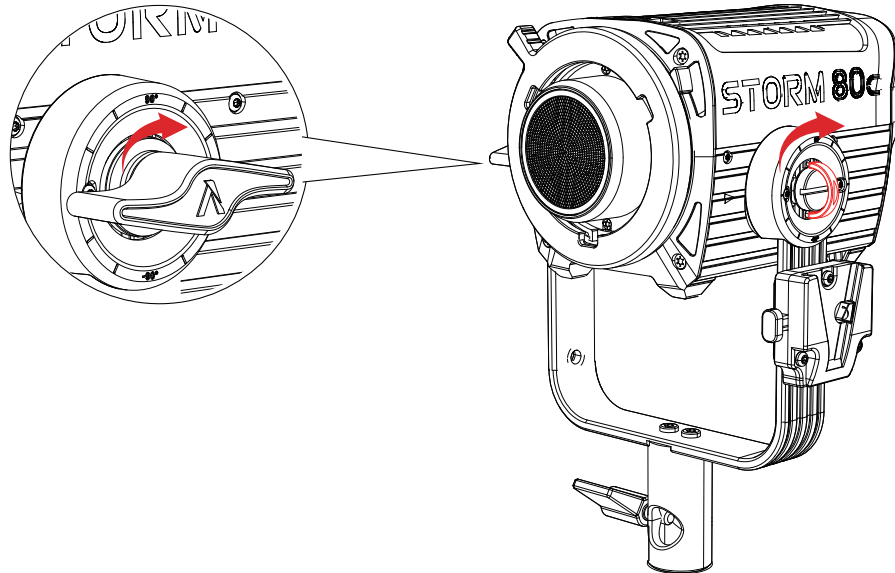

## 5. Setting Up the Lamp

Mount the Lamp Head onto a Baby Pin and tighten in place. Loosen or tighten the tilt lock on the yoke to adjust the fixture's angle of tilt.

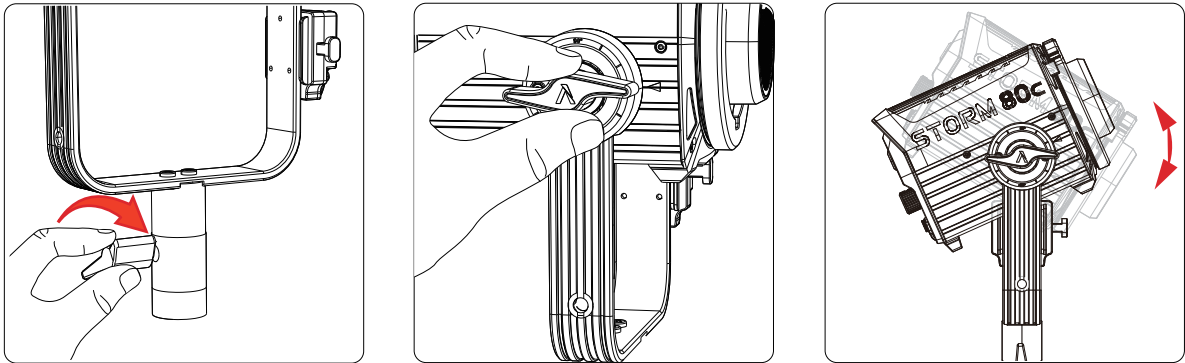

## 6. Powering Up the 80c

1) Connect the AC Power Supply

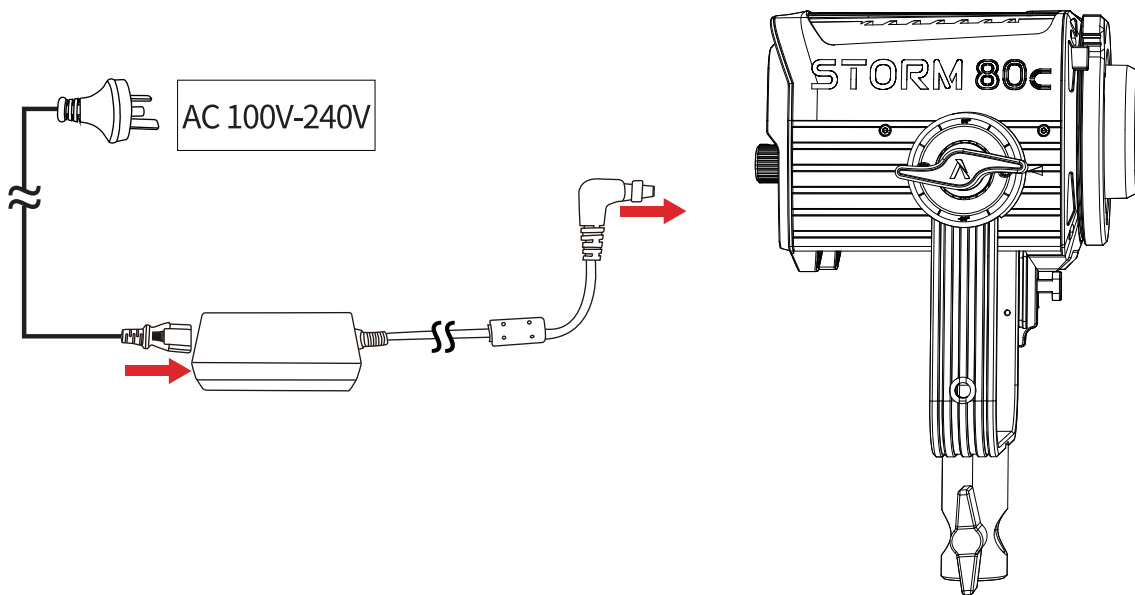

2) Mount the Power Supply to the Yoke's V-Mount Adapter. To remove the Power Supply, press the V-Mount Release Button and slide the Power Supply upward.

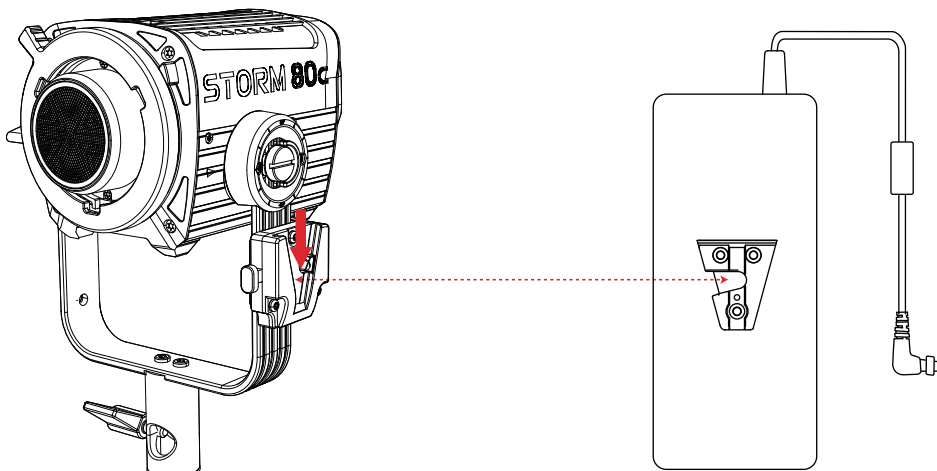

## 7. Powering with External Battery

- 1) Mount the V-Mount Battery to the Yoke's V-Mount.

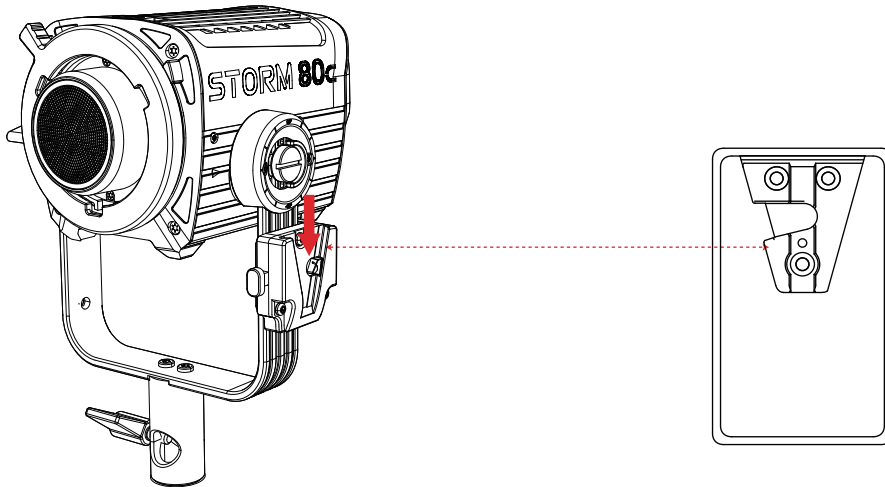

- 2) V-Mount Battery Power with D-Tap Adapter.

Connect the D-Tap Adapter Cable to the battery and the 80c Power Input Port.

To remove the Battery, press the V-Mount Button and slide the Battery upward.

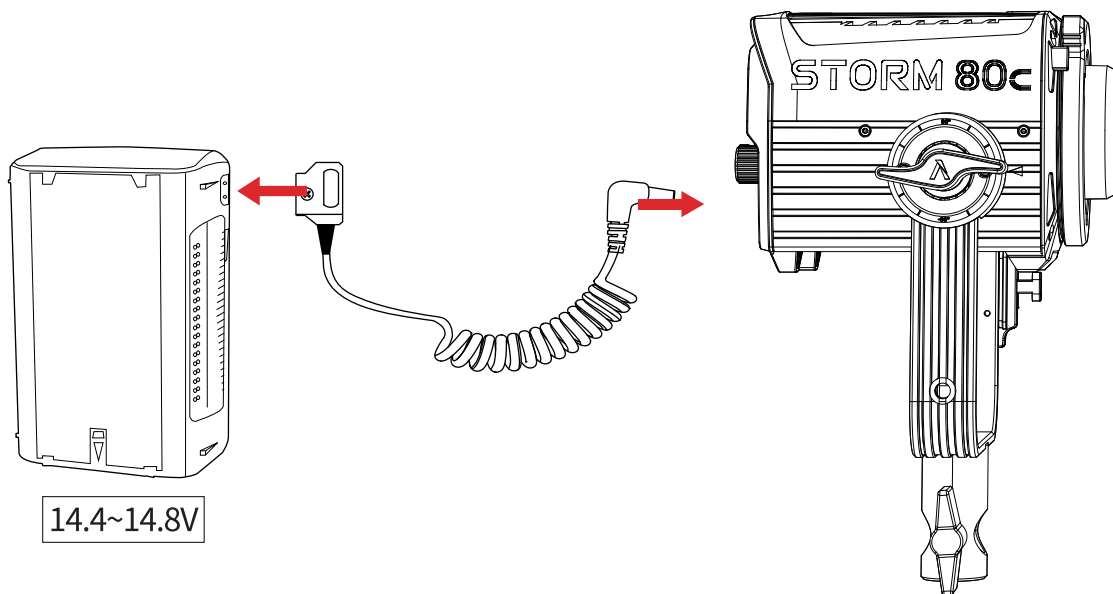

*\* D-Tap Adapter Cable sold separately.*

*\* For proper lamp performance, please follow the battery specifications listed in the Product Specifications.*

### 3) Power Bank Power Supply

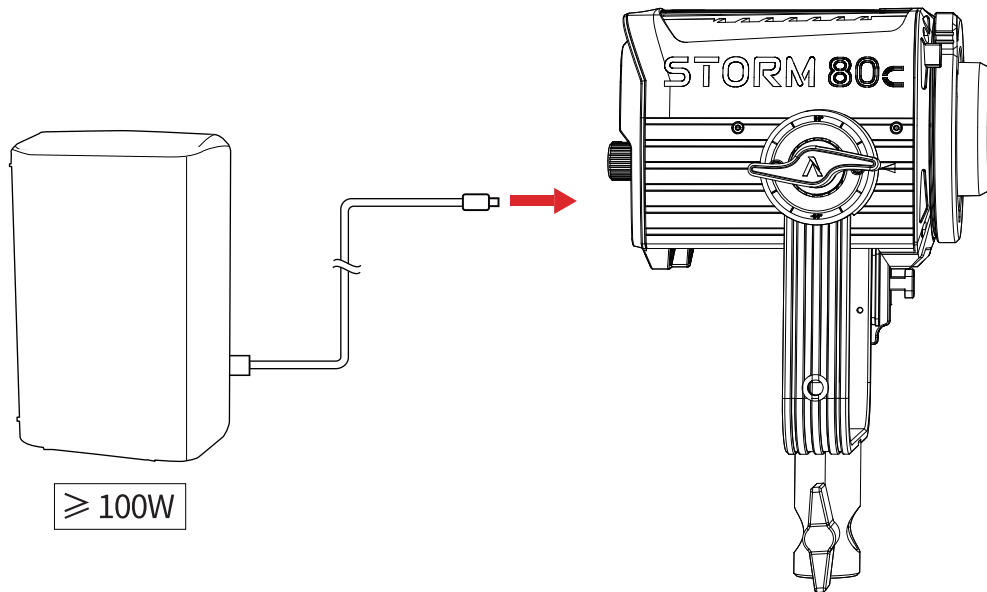

*\* Suitable with 100W and above Power Banks. Power Banks and adapter cables sold separately.*

### 4) PD Power Supply

The STORM 80c can be powered directly using 20V 5A USB-PD or with a battery meeting USB specifications 20V 5A power delivery.

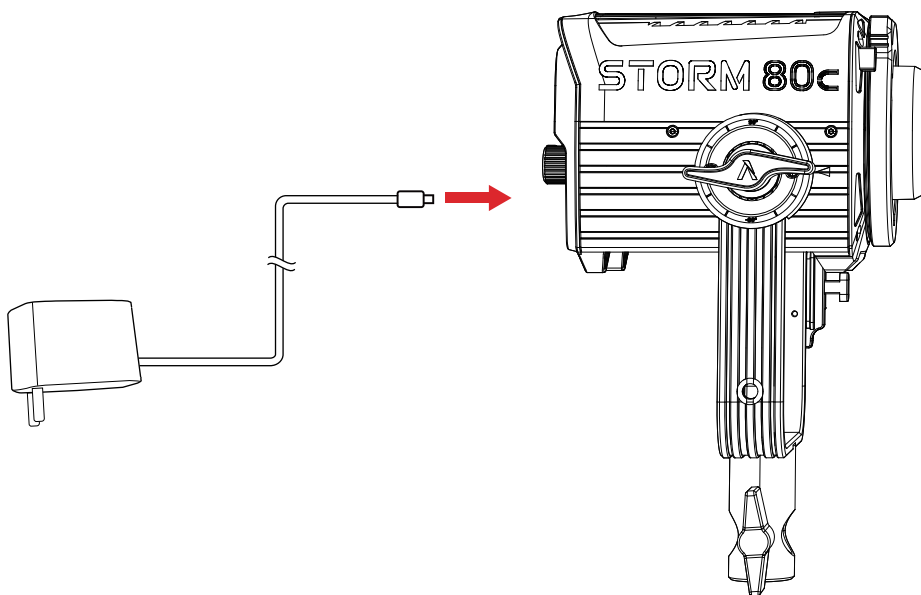

# Operation Instructions

## 1. Powering On/Off

Connect the power supply and press the power button on the Control Box to turn on/off.

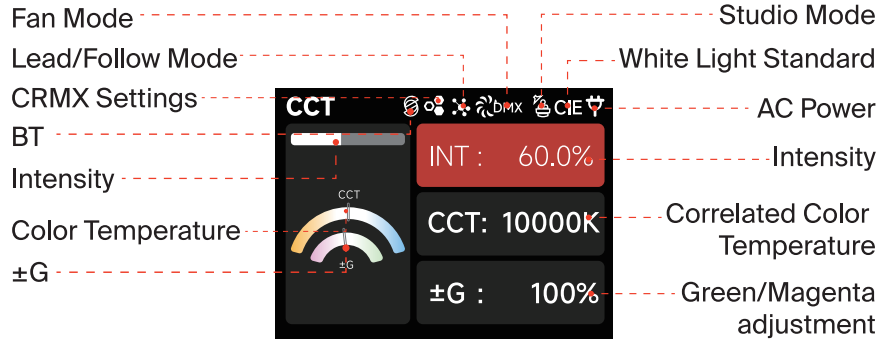
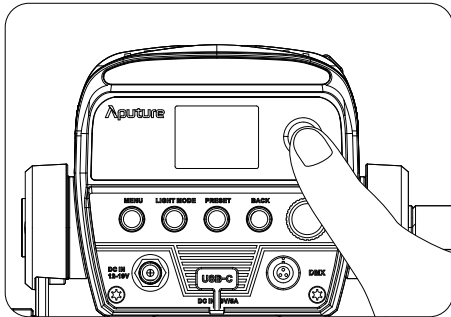

### Status Indicator Icons:

Lead/Follow Mode: Leader		Sidus BT Enabled	
Lead/Follow Mode: Follower		Receiving CRMX data	
Fan Mode: Silent		CRMX connected, no DMX data	
Fan Mode: High		Connected to CRMX, no transmitter found	
Fan Mode: Medium		AC Power Detected	
Fan Mode: Smart		CIE Daylight	
Fan Mode: DMX		Blackbody	
Studio Mode: ON		Studio Mode: OFF	
Battery Power			

## 2. Manual Control

Press the button on the lamp to enter the corresponding modes: MENU, LIGHT MODE, and PRESET.

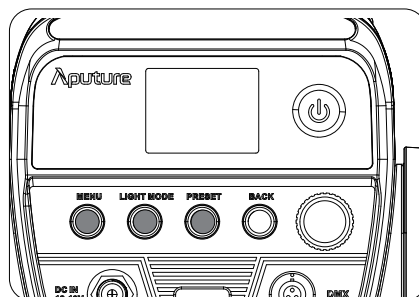

## 2.1 MENU

Press the MENU button to enter the System Menu interface. Choose between Light Mode, Control Settings or System Settings.

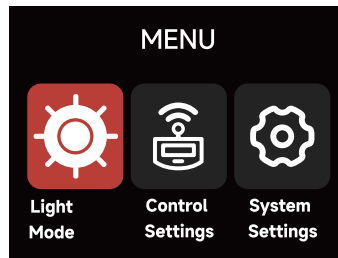

## 2.2 Light Modes

Press the Light Mode Button to enter the Light Mode Menu. Choose between CCT, HSIC+, RGB, GEL, Source, x y, FX, and Sidus FX Modes.

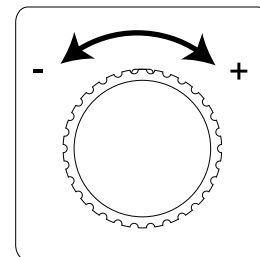
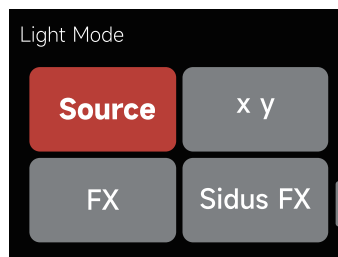

*\*Note: Light Modes can only be accessed when no DMX data is present. Please ensure that DMX data is not being listened to by the 80c in order to use Light Modes.*

### 2.2.1 CCT

Adjust the Color Temperature (1800K-20000K) and the  $\pm$ Green levels (-100% through +100%).

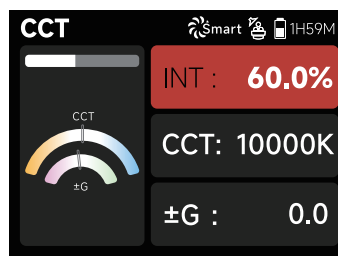

### 2.2.2 HSIC+

Adjust the Intensity (0-100%), Color Temperature (1800K-20000K),  $\pm$ Green level (-100% through +100%), Hue and Saturation.

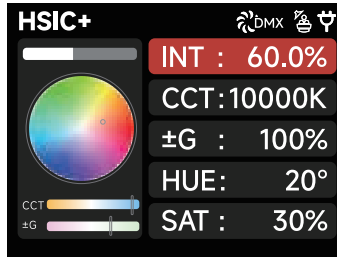

### 2.2.3 RGB

Set the values of Red, Green and Blue (0-100%) to achieve the desired color; then use the Master Intensity to raise and lower the overall brightness of the fixture without changing the colors individually.

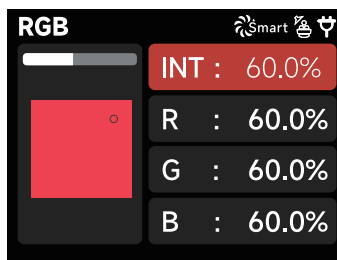

### 2.2.4 GEL

Choose a base Color Temperature of 3200K or 5600K color and the corresponding Rosco or LEE gel to output the desired light.

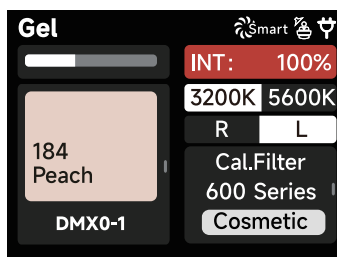

### 2.2.5 Source

Select the light source to mimic and fine tune the xy coordinates.

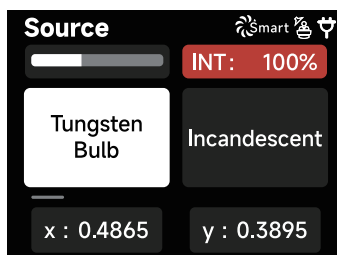

## 2.2.6 x y

Set the Intensity, x and y coordinate value (0-0.8000).

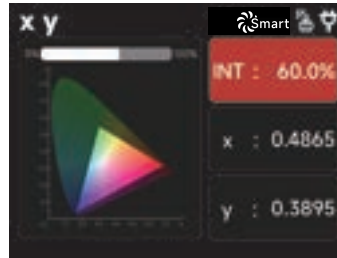

## 2.2.7 FX

Select between FX modes: Fireworks / Explosions / Flames / Paparazzi / Defective Bulb / TV / Pulse / Party Lights / Club / Color Chase / Candle / Welding / Police Car / Flash / Lightning.

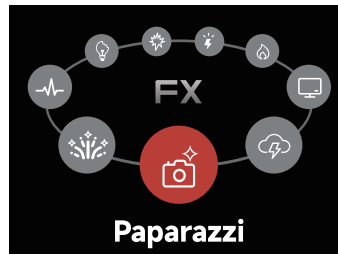

## 2.2.8 Sidus FX

Select either Picker FX or Music FX. Both custom FX choices can save up to 10 FX. "NO FX" indicates that nothing has been saved to this slot. Untitled indicates that an effect has been saved to the slot. The two types of light effects can save 10 custom light effects each. The suffix "NO FX" indicates that no light effect has been saved.

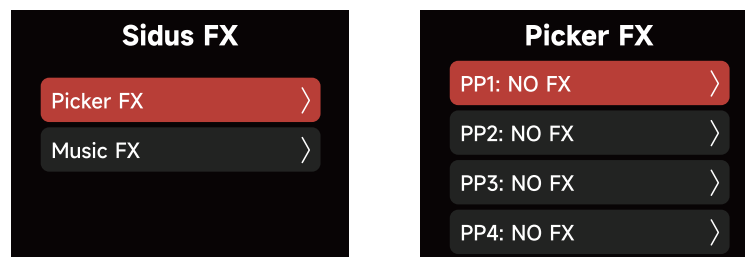

## 2.3 Control Settings

Choose between: DMX Settings, CRMX Settings, and Sidus BT Settings .

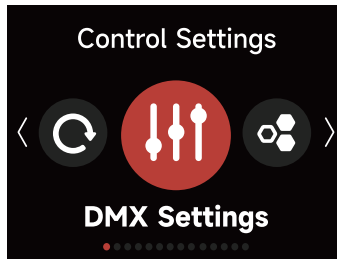

## 2.3.1 DMX Settings

(1) DMX Status Screen: Displays DMX data status, the DMX address, the DMX Profile being used, the CRMX Signal Strength, Fan Mode, Studio Mode in use, Output Mode, Power Status and more.



(2) DMX Address: Set the DMX address of this lamp.



(3) DMX Profile: Choose which DMX Profile to use. Refer to the DMX Chart for the specifics of each profile.

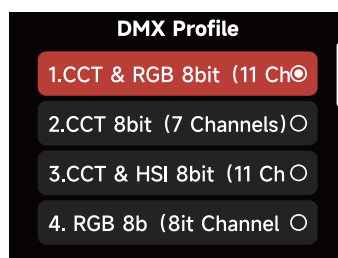

(4) DMX Loss Behavior--Choose from the following options:

I: Hold Last Look: when DMX signal is lost, DMX values will be retained until signal is regained.

II. Black Out: when DMX signal is lost, the light will black out.

III. Fade to Black: when DMX signal is lost, the light will wait for 60 seconds before fading to black.

IV. Hold 2 min.&Fade Out: when DMX signal is lost, the DMX values are retained for two minutes before fading out over a time of 60 seconds.

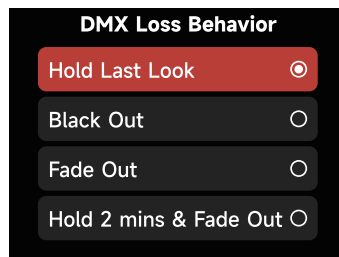

(5) DMX Smoothing: Set the smoothness of DMX dimming.

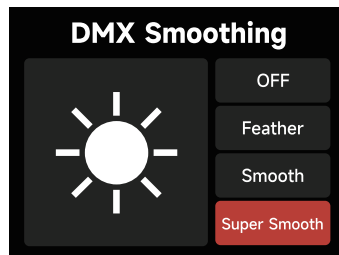

(6) DMX Termination: Turn ON (to help with DMX signal reflection) or OFF.

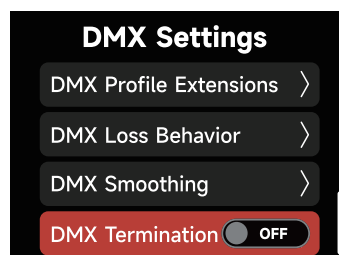

### 2. 3. 2 CRMX Settings

Turn CRMX ON or OFF.

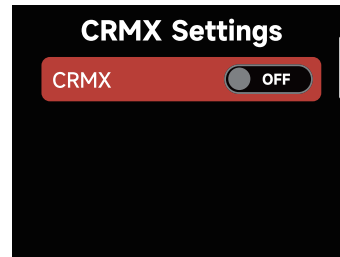
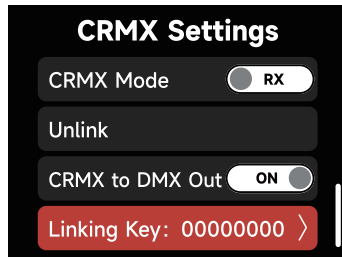

(1) When CRMX is ON/Enabled, the fixture will listen for its previously linked Transmitter. If the fixture is currently unlinked, it will listen for a Transmitter link signal and link to any new CRMX link signal. Users can Unlink from previously linked Transmitters by selecting Unlink. Once a CRMX Link is established and DMX data is present, the display will change to the DMX Status Screen.

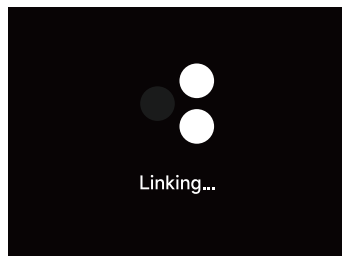

(2) When in CRMX RX Mode, CRMX to DMX512 "ON" pushes the received DMX data out of the DMX Out Port. If "OFF", then no data is pushed out of the DMX Out Port.

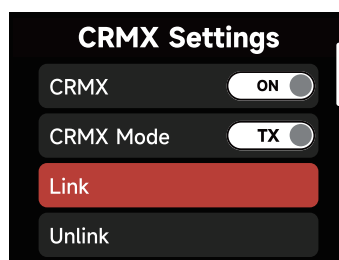

(3) When utilizing CRMX TX Mode, the lamp can transmit DMX data to receivers using CRMX. Linking Key can be used for RX's to link to.

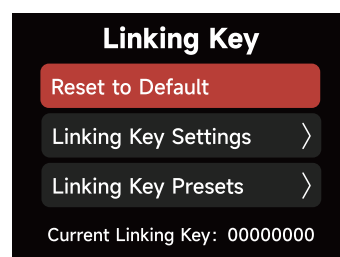
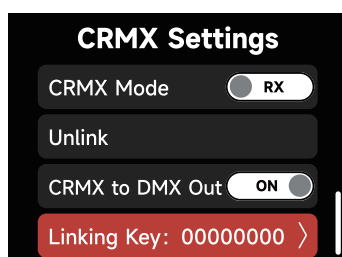

a. In the Linking Key interface, choose an 8 digit number to be the Linking Key. Three digits cannot be the number "0".

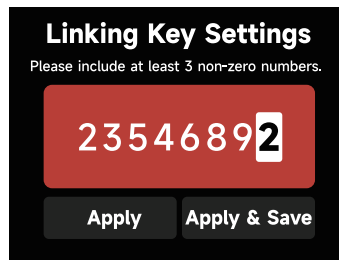

b. Choosing "Apply" sets the Linking Key. Presets can be saved for future use by selecting "Apply & Save".

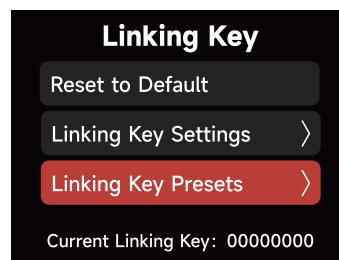
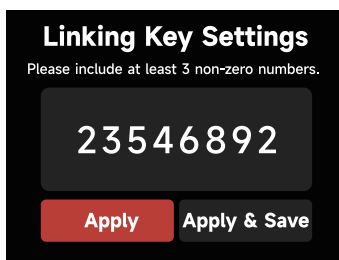

c. Save 10 Presets in total.

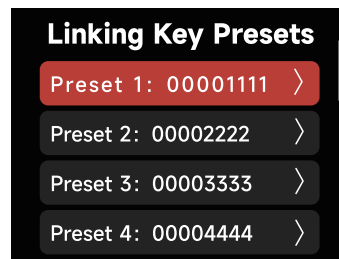
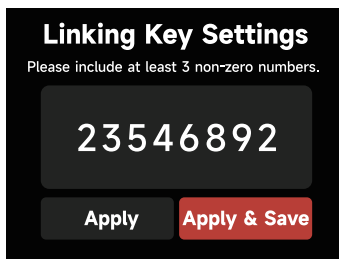

d. In the Linking Key Preset interface, save up to 10 Presets by choosing "Save" or set the Control Box's Linking Key and save it as the selected Preset by choosing "Apply and Save".

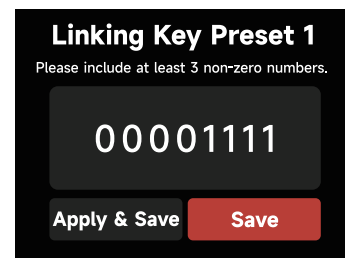
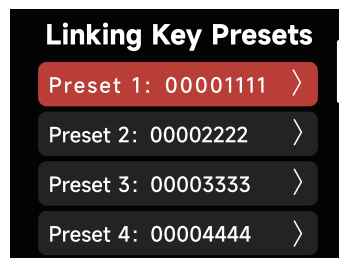
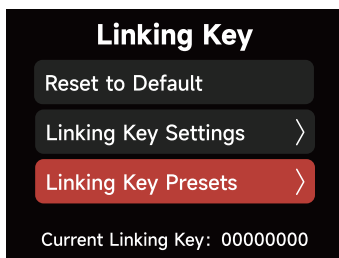

### (5) CRMX RX (Receiving) Status

a. Signal Strength: When DMX data is provided to the Control Box acting as an RX , the DMX Status Screen will indicate the CRMX signal strength the Control Box is receiving.

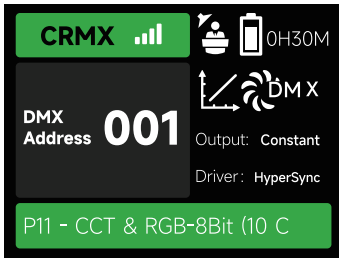

#### Signal Strength



b. No DMX data present

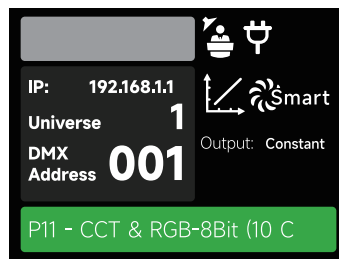

d. The Control Box CRMX RX is out of range of its TX. Check that the TX is powered On and within range.



### 2.3.3 Sidus BT Settings

(1) Turn Sidus BT ON or OFF in the Sidus BT settings.

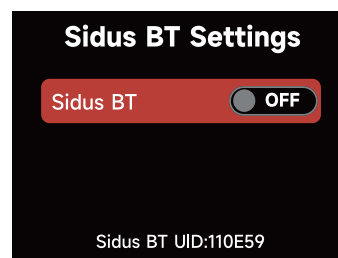
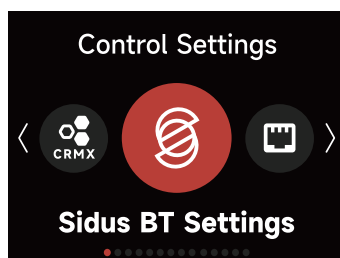

(2) When Bluetooth is "ON": the serial number is displayed here to facilitate connecting with the Sidus Link Pro and Sidus Link Apps. Use Sidus BT Reset to allow your Sidus Link device to connect with a new controller. If Sidus BT fails to reset, a "Reset Failed" warning will pop up before returning to the Sidus BT Reset display.

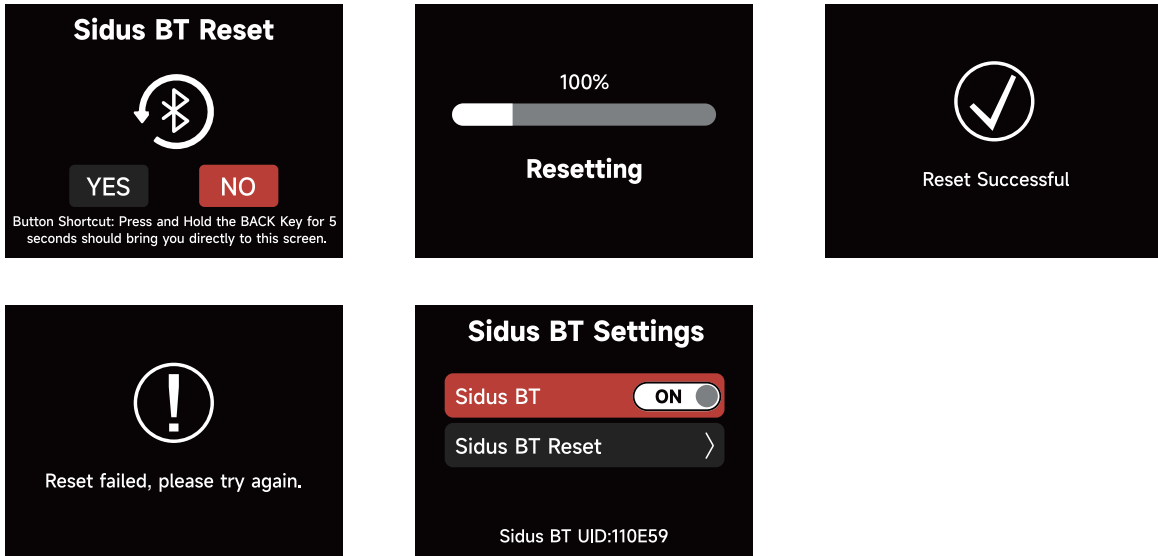

### 2.3.4 Lead/Follow Mode

In this interface, set fixtures as either the Leader or the Follower (Leader/"OFF").

The Leader automatically sends its settings to the Follower fixtures for synchronization.

Batch upgrades of the firmware from a USB drive in the Leader's port is also possible; the Leader Fixture should be connected with the Follow Fixtures via DMX to enable batch upgrades.

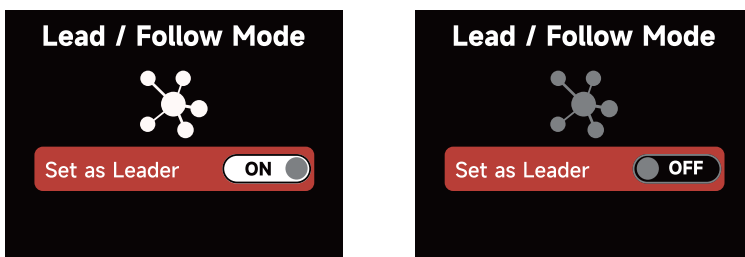

### 2.4 System Settings

System Settings include: Dimming Curve, Output Settings, White Light Standard, Lead/Follow Mode, High Speed Mode, Fan Mode, Studio Mode, Screensaver Settings, Language, Product Info, Firmware Update, and Factory Reset options.

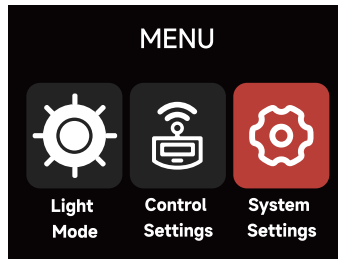

### 2. 4. 1 Dimming Curve

The following Dimming Curves are available: Linear, Logarithmic, S-Curve and Exponential.

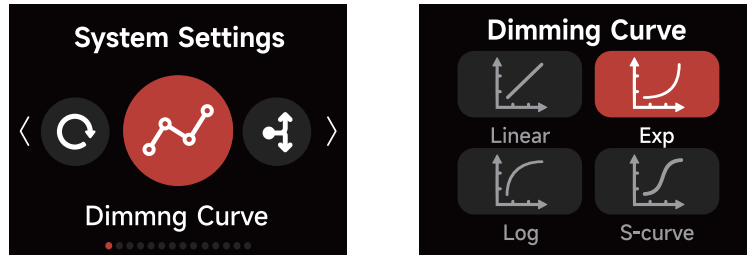

### 2.4.2 Output Settings

#### 1) Constant Output:

The lamp's brightness is kept consistent throughout the color temperature range.

#### 2) Max Output: The lamp's brightness is prioritized throughout the color temperature range.

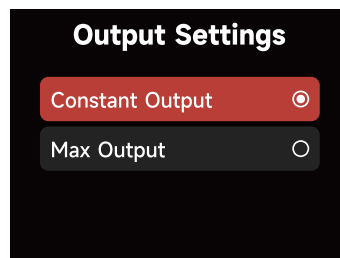

### 2.4.3 White Light Standard

#### (1) CIE Daylight: meets the sunlight standard

(5000K-10000K, Duv is controlled at 0.0020~0.0040);

#### (2) Blackbody: meets the blackbody luminescence standard

(Duv is controlled near the blackbody trajectory line).

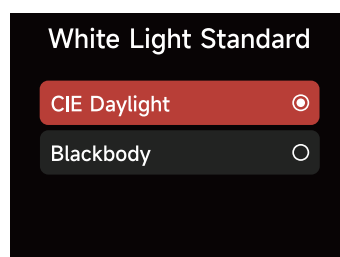

## 2.4.4 Fan Mode

In the System Settings Fan Mode, rotate the Select Wheel and press to choose between Smart, High, Medium, Silent and DMX Controlled Fan Mode.

When using the DMX Controlled Fan Mode, the options for the Fan are:

- 1) Smart: able to work in -20°C/-4°F through 45°C/113°F environment, the lamp will automatically adjust the fan speed according to different ambient temperatures.
- 2) High: able to work in -20°C/-4°F through 45°C/113°F environment, fan will maintain its highest speed. In High-Speed Mode, the fan uses the Max Fan setting.
- 3) Medium: Capable of working in -20°C/-4°F through 35°C/95°F environments, the fan uses a medium speed. Medium is the slowest speed possible for Maximum Output.
- 4) Silent: When working in an environment of -20°C/-4°F–45°C/113°F, the fan stays OFF, but the output of the lamp is limited to 20W.
- 5) DMX Controlled: See the STORM 80c DMX Chart for details.

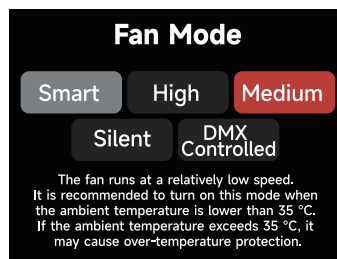

## 2.4.5 Studio Mode

When Studio Mode is enabled (ON), the fixture will power on when connected to live power. When Studio Mode is disabled (OFF), press the power button to power on or power off the fixture.

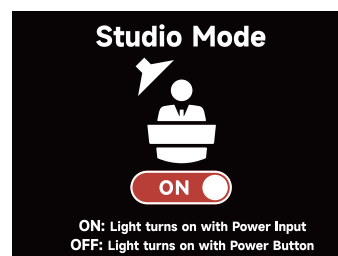
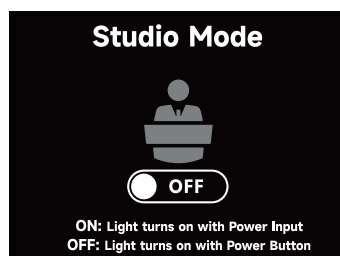

## 2.4.6 Screensaver

Select the Screensaver time and display behavior.



## 2.4.7 Language

Select between English or Chinese and press the Select Wheel to confirm.

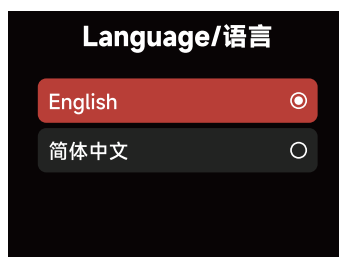

## 2.4.8 Product Information

The Firmware Version, SN, Sidus BT ID, Hardware Version and Operating status, can all be checked in the Product Info interface.

- 1) Firmware Version: display the Firmware Version of the Control Box and attached Lamp Head.
- 2) SN: Serial Number
- 3) Sidus BT ID.
- 4) Hardware Version: display the hardware versions of the Control Box and attached Lamp Head.
- 5) Operating Status: display the Temperature, Lamp Head Run Time, and any Error Codes



- 1) Firmware Version: display the Firmware Version of the lamp.



2) Hardware Version: display the hardware version of the Lamp Head.



3) Operating Status: display the Temperature, Lamp Head Run Time, and any Error Codes.

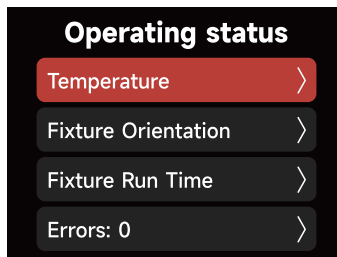

a. Temperature: Display the Ambient temperature, MCU temperature, and LED temperature.

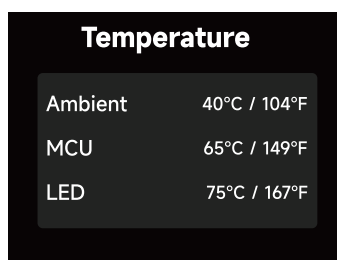

b. Fixture Run Time: Display the LED engine use time

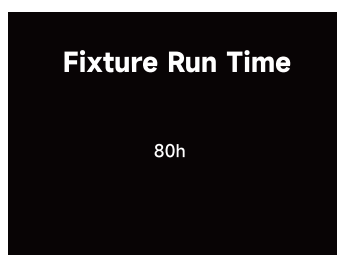

c. Errors:

If the lamp is operating as expected, then the display will read: "Errors: 0" Errors are divided into two categories.

i. Serious error: When a serious error occurs, the fixture cannot be used and will be locked for protection. Please respond to the error according to the fault prompt.

ii. General error: When a general error occurs, the fixture is still available for use; enter the Product Info interface to view the error details.

### 2.4.9 Firmware Update

Upgrade the firmware by inserting a USB flash drive with the latest firmware on its root drive into the USB-A port of the Control Box . The current firmware version is also listed in this interface. NOTE: The fixture can also be updated via Sidus Link with Sidus BT turned ON and a Wi-Fi internet connection on your Sidus Link/SidusLink pro device. Remember to update both the Control Box and the connected Lamp Head with any new firmware.

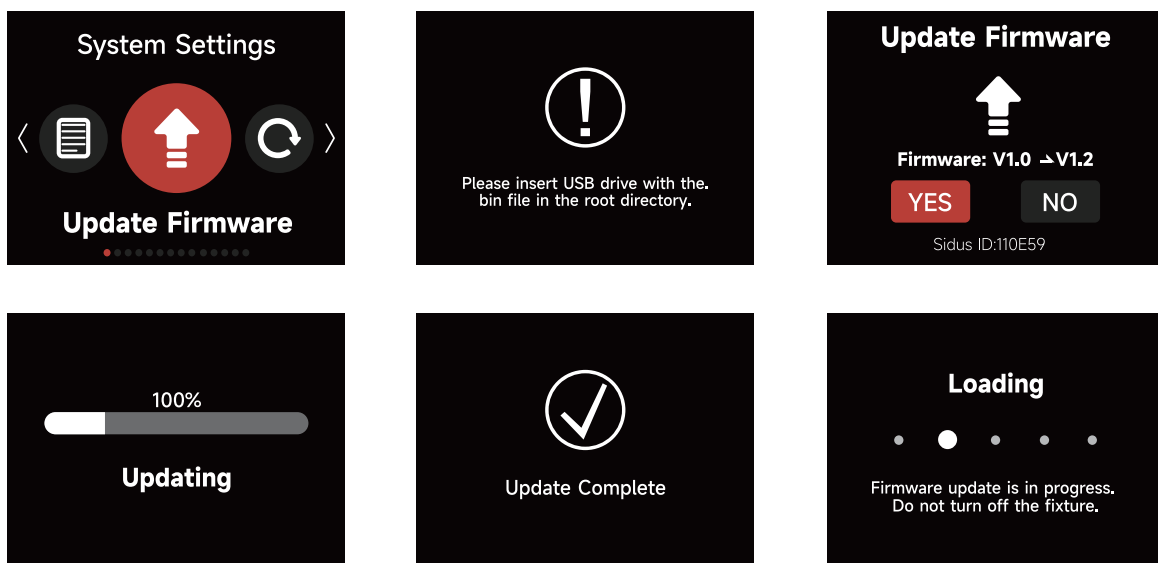

### 2.4.10 Factory Reset

In the Factory Reset Menu, select "YES" if you wish to Factory Reset the fixture; select "NO" to cancel. Choose whether to reset CRMX and Sidus BT and the desired Default Language.

\*NOTE: Hold the MENU Button for 5 seconds for a Factory Reset shortcut to appear.

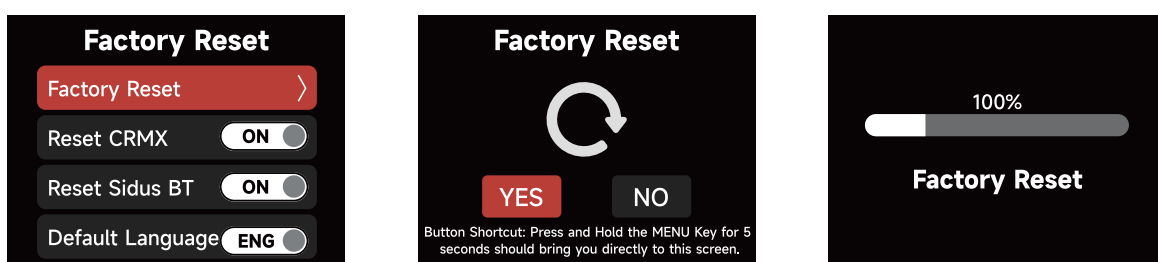

## Factory Settings:

Light Mode	CCT; Color Temperature:3200K
Intensity	0
Output Mode	Maximum Output
Lead/Follow Mode	Off
High Speed Mode	Off
Screensaver	30 minutes
White Light Standard	CIE Daylight
Fan Mode	Smart
Dimming Curve	Linear
Studio Mode	On
Fx Mode	Fireworks, Brightness 0%, Color Temperature 3200K, Frequency 5
DMX	Channel 001, Hold Last Look DMX Termination: Off DMX Smooth: Smooth

## 2.5 Presets

10 Light Mode Presets can be saved. Choose your settings within the CCT, xy or FX Mode. Then press the PRESET button to open the Preset interface. Select the Preset number to open, replace or delete the Preset.

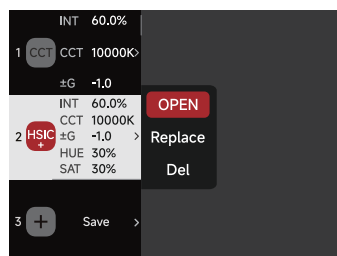

### 3. Control with a DMX Console

#### 3.1 Connect the Lighting Console to the STORM 80c Control Box DMX IN Port:

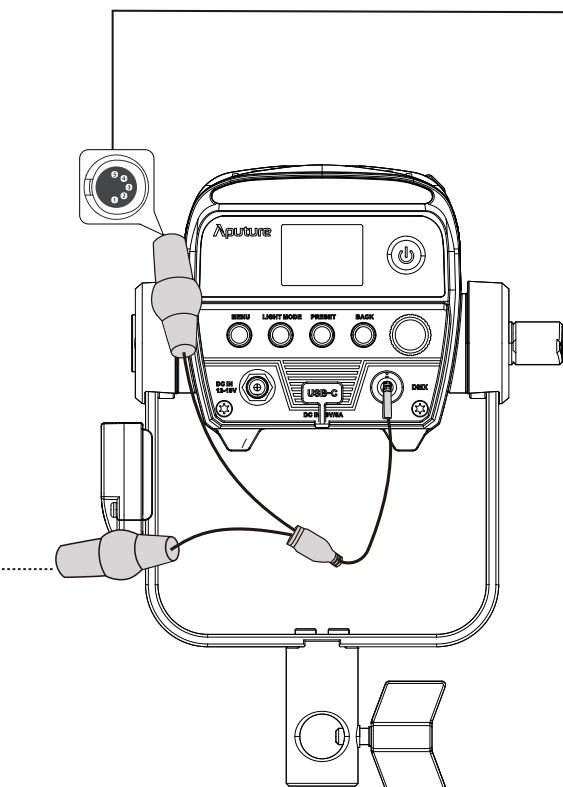
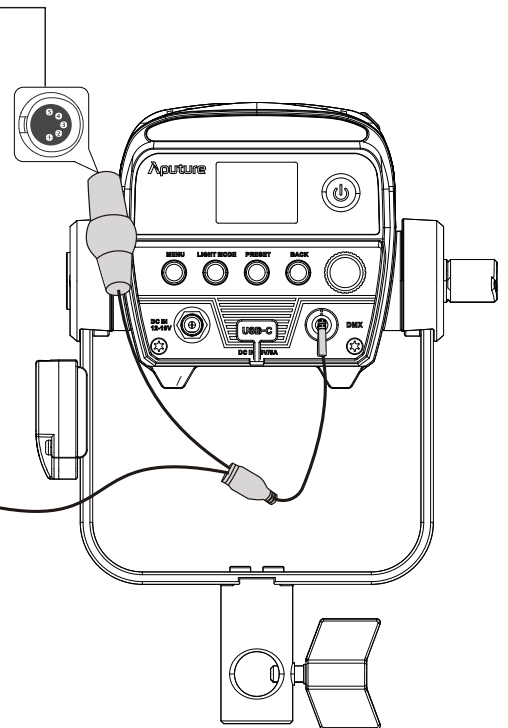
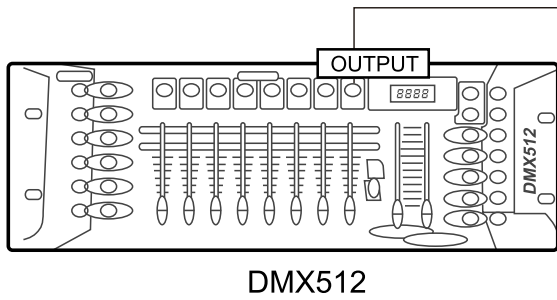
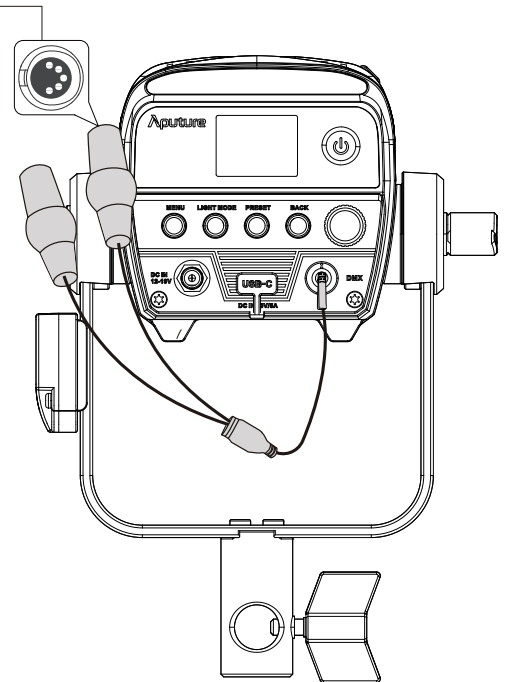
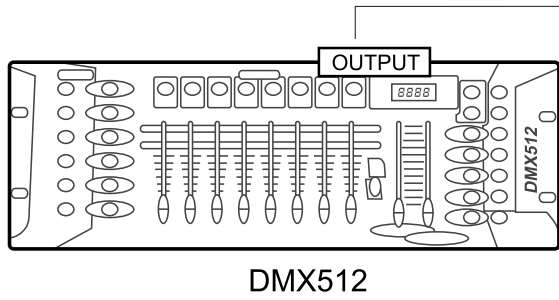

### 3.2 Controlling via DMX

When the number of DMX console channels is consistent with that of the control box, the console can be used to adjust the brightness. Applicable to single or multiple connection modes.

### 3.3 . DMX Profile Control

STORM 80c supports several DMX profiles. Please download the DMX Chart on the official website (<https://aputure.com>) to view detailed configurations.

## 3. Sidus Link Pro and Sidus Link

Download Sidus Link and Sidus Link Pro from the iOS App Store or the Google Play Store. Visit [Aputure.com](https://aputure.com) for more details on enhancing the Aputure experience with these Apps.



Get Sidus Link® App  
& Sidus Link Pro®



<https://help.sidus.link/>

# Product Specifications

Input	100W	Output Power(Max)	80W
Voltage Input Range	100-240V AC	Operating Current	5.3A
CRI	97	TLCI	99
SSI(D56)	84	SSI (D32)	88
Rf	96	Rg	103
CCT	1800-20000K	IP Rating	IP65
V-Mount Battery	14.4V	Power Supply Specifications	19V/5.3A
USB-C	IN 20V 5A	h=Heat Sink	Active Cooling
	Out 5V 0.5A		
Operating Temperature	-20°C ~ +45°C	Storage Temperature	-40°C ~ 45°C
Bluetooth Control Distance	100m	CRMX Control Distance	100m
Size	Without Yoke	100.68(W)×103.65(H)×146.9(L)mm	
	With Yoke	167.13(W)×225.17(H)×146.9(L)mm	
Weight	Without Yoke	1.01 kg	
	With Yoke	1.35 kg	
Screen	Type: TFT	Firmware Updating	Sidus Link
	Size: 95.04 x 23.35mm		Sidus Link Pro
	Resolution: 480 * 128		USB-C
External Power Adapter	AC IN: 100-240V		
	DC OUT: 19V /5.3A		
	AC Cable: 4M		

# Photometrics

CCT	Distance	Bare light	Hyper reflector	Mini diffuser	CF4 Fresnel		Light Dome 40		Lantern 30
					15°	40°	Stop 1	Stop 2	
1800K	1m	4485 Lux	13030 Lux	878 Lux	24995 Lux	8666 Lux	1640 Lux	1190 Lux	686 Lux
		417 fc	1211 fc	82 fc	2311 fc	806 fc	152 fc	111 fc	64 fc
	2m	1162 Lux	3354 Lux	223 Lux	5833 Lux	2322 Lux	383 Lux	263 Lux	151 Lux
		108 fc	312 fc	21 fc	535 fc	203 fc	36 fc	24 fc	14 fc
	3m	500 Lux	1366 Lux	96 Lux	2418 Lux	998 Lux	164 Lux	113 Lux	65 Lux
		46 fc	127 fc	9 fc	236 fc	93 fc	15 fc	11 fc	6 fc
3200K	1m	6300 Lux	19090 Lux	1220 Lux	34625 Lux	11981 Lux	2302 Lux	1666 Lux	964 Lux
		586 fc	1774 fc	113 fc	3215 fc	1122 fc	214 fc	155 fc	90 fc
	2m	1619 Lux	4682 Lux	308 Lux	7466 Lux	3256 Lux	534 Lux	366 Lux	212 Lux
		150 fc	435 fc	29 fc	744 fc	283 fc	50 fc	34 fc	20 fc
	3m	696 Lux	1911 Lux	133 Lux	2417 Lux	1399 Lux	230 Lux	158 Lux	91 Lux
		65 fc	178 fc	12 fc	328 fc	129 fc	21 fc	15 fc	8 fc
4300K	1m	6540 Lux	19930 Lux	1275 Lux	36592 Lux	12590 Lux	2413 Lux	1733 Lux	1006 Lux
		608 fc	1852 fc	119 fc	3223 fc	1121 fc	224 fc	161 fc	94 fc
	2m	1687 Lux	4889 Lux	321 Lux	7771 Lux	3325 Lux	555 Lux	380 Lux	219 Lux
		157 fc	454 fc	30 fc	743 fc	283 fc	52 fc	35 fc	20 fc
	3m	722 Lux	2001 Lux	138 Lux	3472 Lux	1452 Lux	238 Lux	164 Lux	94 Lux
		67 fc	186 fc	13 fc	327	129 fc	22 fc	15 fc	9 fc
5600K	1m	6500 Lux	19850 Lux	1261 Lux	36000 Lux	12500 Lux	2398 Lux	1734 Lux	1001 Lux
		604 fc	1845 fc	117 fc	3197 fc	1110 fc	223 fc	161 fc	93 fc
	2m	1681 Lux	4859 Lux	326 Lux	7840 Lux	3305 Lux	562 Lux	385 Lux	222 Lux
		156 fc	452 fc	30 fc	738 fc	279 fc	52 fc	36 fc	21 fc
	3m	725 Lux	1987 Lux	138 Lux	3512 Lux	1459 Lux	241 Lux	166 Lux	94 Lux
		67 fc	185 fc	13 fc	324 fc	127 fc	22 fc	15 fc	9 fc
6500K	1m	6404 Lux	19650 Lux	1241 Lux	34723 Lux	12296 Lux	2345 Lux	1714 Lux	986 Lux
		595 fc	1826 fc	115 fc	3124 fc	1083 fc	218 fc	159 fc	92 fc
	2m	1653 Lux	4781 Lux	339 Lux	7495 Lux	3207 Lux	548 Lux	371 Lux	214 Lux
		154 fc	444 fc	32 fc	718 fc	272 fc	51 fc	34 fc	20 fc
	3m	713 Lux	1956 Lux	136 Lux	3423 Lux	1436 Lux	236 Lux	160 Lux	93 Lux
		66 fc	182 fc	13 fc	316 fc	124 fc	22 fc	15 fc	9 fc
8000K	1m	6197 Lux	18560 Lux	1199 Lux	33248 Lux	11814 Lux	2258 Lux	1644 Lux	942 Lux
		576 fc	1725 fc	111 fc	2997 fc	1038 fc	210 fc	153 fc	88 fc
	2m	1583 Lux	4584 Lux	300 Lux	7505 Lux	3108 Lux	524 Lux	359 Lux	207 Lux
		147 fc	426 fc	28 fc	689 fc	261 fc	49 fc	33 fc	19 fc
	3m	684 Lux	1874 Lux	130 Lux	3285 Lux	1375 Lux	226 Lux	155 Lux	89 Lux
		64 fc	174 fc	12 fc	304 fc	119 fc	21 fc	14 fc	8 fc
10000K	1m	5981 Lux	17720 Lux	1160 Lux	32264 Lux	11558 Lux	2208 Lux	1603 Lux	922 Lux
		556 fc	1647 fc	108 fc	2925 fc	1009 fc	205 fc	149 fc	86 fc
	2m	1541 Lux	4466 Lux	298 Lux	6905 Lux	3030 Lux	512 Lux	350 Lux	202 Lux
		143 fc	415 fc	28 fc	673 fc	255 fc	48 fc	33 fc	19 fc
	3m	666 Lux	1825 Lux	127 Lux	3197 Lux	1340 Lux	220 Lux	151 Lux	86 Lux
		62 fc	170 fc	12 fc	296 fc	116 fc	20 fc	14 fc	8 fc

CCT	Distance	Bare light	Hyper reflector	Mini diffuser	CF4 Fresnel		Light Dome 40		Lantern 30
					15°	40°	Stop 1	Stop 2	
15000K	1m	5607 Lux	16730 Lux	1082 Lux	30307 Lux	10869 Lux	2089 Lux	1512 Lux	864 Lux
		521 fc	1555 fc	101 fc	2744 fc	950 fc	194 fc	141 fc	80 fc
	2m	1457 Lux	4220 Lux	281 Lux	6492 Lux	2853 Lux	482 Lux	330 Lux	190 Lux
		135 fc	392 fc	26 fc	633 fc	240 fc	45 fc	31 fc	18 fc
	3m	629 Lux	1724 Lux	120 Lux	3030 Lux	1263 Lux	207 Lux	142 Lux	82 Lux
		58 fc	160 fc	11 fc	279 fc	109 fc	19 fc	13 fc	8 fc
20000K	1m	5302 Lux	15920 Lux	1048 Lux	28920 Lux	10397 Lux	2003 Lux	1447 Lux	834 Lux
		493 fc	1480 fc	97 fc	2552 fc	884 fc	186 fc	134 fc	78 fc
	2m	1397 Lux	4043 Lux	270 Lux	6217 Lux	2735 Lux	463 Lux	316 Lux	182 Lux
		130 fc	376 fc	25 fc	604 fc	228 fc	43 fc	29 fc	17 fc
	3m	604 Lux	1659 Lux	115 Lux	2912 Lux	1211 Lux	199 Lux	137 Lux	78 Lux
		56 fc	154 fc	11 fc	260 fc	101 fc	18 fc	13 fc	7 fc

## Safety Instructions

When using this product, basic safety precautions should always be followed, including:

1. Read and understand all instructions before using the fixture.
2. Close supervision is necessary when any fixture is used by or near children. Do not leave the fixture unattended while in use.
3. Care must be taken as burns can occur from touching hot surfaces.
4. Do not operate the fixture if any cord is damaged, or if the fixture has been dropped or damaged, until it has been examined by qualified service personnel.
5. Position any power cables such that they will not be tripped over, pulled, or put into contact with hot surfaces.
6. If an extension cord is necessary, a cord with an amperage rating at least equal to that required by the fixture should be used. Cords rated for less amperage will overheat.
7. Always unplug the lighting fixture from the electrical outlet before cleaning and servicing, or when not in use. Never yank the cord to remove the plug from the outlet.
8. Let the lighting fixture cool completely before storing. Unplug the cables from the lighting fixture and store them in assigned spaces of the carrying case (if being used).
9. Do not immerse this fixture in water or any other liquid to avoid electric shock.
10. Do not disassemble the fixture to avoid the risk of fire or electric shock. Contact [cs@aputure.com](mailto:cs@aputure.com) or take the lighting fixture to qualified service personnel when service or repair is required. Incorrect reassembly may cause electric shock when the lighting fixture is in use.
11. Using any accessory attachment not recommended by the manufacturer may increase the risk of fire, electric shock or injury to any persons operating the fixture.
12. Power this fixture by connecting it to a grounded outlet.
13. Remove the Protective Cover before use.
14. Do not block the ventilation openings or look at the LED light source directly when it is powered on. Do not touch the LED light source in any condition.
15. Do not place the product near combustible and volatile solvents to avoid product damage.
16. Use a soft and dry cloth to clean the device.
17. Ensure all the ports and plugs are completely dry when using the fixture in wet environments to avoid short circuit or electric shock.



18. Service and maintenance should only be carried out by authorized service personnel. Any malfunctions caused by unauthorized disassembly are not covered by the warranty. The user may pay for service and maintenance.

19. When hanging the fixture overhead, always ensure an extra safety measure has been attached -such as safety chains- that is certified for the weight of the fixture. We recommend only using the original Aputure cable accessories. Please note that any malfunctions caused by using unauthorized accessories are not covered by the warranty. The user may pay for service and maintenance. When hanging the fixture overhead, always ensure an extra safety measure has been attached -such as safety chains- that is certified for the weight of the fixture.

20. This product is certified by RoHS, CE, KC, PSE, and FCC. Please operate the product in full compliance with relevant country's standards. Any malfunctions caused by incorrect use are not covered by the warranty. The user may pay for service and maintenance.

21. The User's Manual was formulated based on rigorous tests performed by the Company. No further notice will be given in the event of any change in its design and specifications.

## FCC Declaration of Conformity

### WARNING

Changes or modifications to this product that are not expressly approved by the manufacturer are prohibited and voids the user warranty.

### ATTENTION

This equipment has been tested and found to comply with the limits for a Class B digital device, pursuant to Part 15 of the FCC Rules. These limits are designed to provide reasonable protection against harmful interference in a residential installation. This equipment generates, uses, and can radiate radio frequency energy and, if not installed and used in accordance with the instructions, may cause harmful interference to radio communications. However, there is no guarantee that interference will not occur in a particular installation.

If this equipment does cause harmful interference to radio or television reception, which can be determined by turning the equipment off and on, the user is encouraged to try to reorient or relocate the receiving antenna.

- Increase the separation between the equipment and receiver.
- Plug the device into the socket of a different circuit than the socket that the receiver is plugged into.
- Consult the dealer or experienced radio/TV technician for assistance.

### RF Statement

This device has been evaluated to meet general RF exposure requirements.

# Disclaimer

Please read the Product Manual before usage to ensure that you have fully understood the instructions and can correctly operate the device. After your reading, please keep the Product Manual properly for reference in the future. If you fail to operate the product correctly, you may get injured seriously or harm others seriously, or damage the product and result in your property damage. Your operation of the product will be deemed that you have understood, recognized and accepted all clauses and content of this document. Users undertake to be responsible for their behaviors and the consequences accordingly. Aputure will not be responsible for all losses arising from users' operation of this product not in accordance with the User's Manual.

The Company reserves the right for the final explanation of this document and all documents relating to the product on the premise of compliance with laws and regulations. No further notice will be given in the event of any update, revision or termination. Please access the official website of Aputure for the up-to-date product information.